

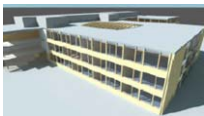

# Commissioning tools for improved energy performance



## Results of IEA ECBCS ANNEX 40





## Foreword

This report and the attached CD-ROM summarizes the work of IEA-ECBCS Annex 40 **Commissioning of Building HVAC Systems for Improved Energy Performance**. It is based on the research findings from the participating countries. The publication is an official Annex report.

The report synthesizes the Annex results.

Chapter 1 to 3 can be considered as an introduction to the commissioning process.

Chapter 4, 5, 6 describes three groups of tools which can be used for commissioning

Chapter 7 and appendix 2 give a vision of the 23 projects where the tools developed within the Annex were used.

A glossary is presented in appendix 1. It will deeply facilitate the understanding of the words used.

The CD Rom is a source of information. It includes a detailed description of the different commissioning tools developed within the Annex, of their applications in different commissioning projects and in some cases a demo version of the tool. It is structured as an electronic version of the report which enables an easy and structured access to all the documented results of the Annex.

Commissioning is still an emerging activity. We hope that this report will be useful to help its development and will be the basis of further work in this wide field.

*JC Visier*  
*Editor*





## **Acknowledgement**

The material presented in this publication has been collected and developed within an Annex of the IEA Implementing Agreement Energy Conservation in Buildings and Community systems, Annex 40, "Commissioning of Building HVAC Systems for Improved Energy Performance".

The report and the CD Rom is the result of an international joint effort conducted in 14 countries. All those who have contributed to the project are gratefully acknowledged.

On behalf of all participants the members of the Executive Committee of IEA Energy Conservation in Building and Community Systems Implementing Agreement as well as the funding bodies are also gratefully acknowledged.

A list of participating countries, institutes, and people as well as funding organizations can be found at the end of this report.



# Content

<b>1. COMMISSIONING, WHAT IS IT? WHY DO WE NEED IT?</b>	<b>9</b>
<b>2. THE ANNEX 40 PROJECT</b>	<b>10</b>
2.1 Task A: Commissioning process	10
2.2 Task B: Manual commissioning procedures	11
2.3 Task C: BEMS-assisted commissioning tools	11
2.4 Task D: Use of models and commissioning	11
2.5 Task E Commissioning projects	11
2.6 References	12
<b>3. THE COMMISSIONING PROCESS</b>	<b>13</b>
3.1 Commissioning should be seen as a process	13
3.2 Possible organisations for commissioning	16
3.3 Tools to help structuring the commissioning process	17
3.4 Learn more on Different countries approaches	27
3.5 References	29
<b>4. FUNCTIONAL PERFORMANCE TESTING (FTP)</b>	<b>32</b>
4.1 Introduction	32
4.2 The different audiences	33
4.3 A global vision of FPT	33
4.4 Description of individual FPT	36
4.5 FPT specifications developed in the Annex	40
4.6 Residential buildings	61
4.7 Other FPT sources and references	63
<b>5. USING THE BUILDING CONTROL SYSTEM FOR COMMISSIONING</b>	<b>66</b>
5.1 Introduction	66
5.2 Results of practitioner surveys	67
5.3 Methods to Commission the control system and Energy systems	68
5.4 Implementation of Automated Commissioning Tools	74
5.5 Data handling	77
5.6 Data visualization with PIA	77
5.7 Tools tested during the Annex	79
5.8 Conclusions	80
5.9 References	80
<b>6. USING MODELS IN COMMISSIONING</b>	<b>82</b>
6.1 Using models at the component level	82
6.2 Using simulation models at the building level	105
<b>7. VISIT COMMISSIONING PROJECTS</b>	<b>120</b>
7.1 List of case studies	121
7.2 Typologies	122
7.3 DataBase of the case studies	124
<b>APPENDIX 1: GLOSSARY</b>	<b>125</b>
<b>APPENDIX 2: POSTERS OF THE DEMONSTRATION SITE</b>	<b>141</b>
<b>APPENDIX 3: PARTICIPANTS TO THE ANNEX</b>	<b>195</b>

*The edition of the chapters was managed by:*

- J.C. Visier ..... Ch. 1 - 2 - 3
- J. Lebrun - P. André ..... Ch. 4
- D. Choiniere - T. Salisbury - H. Vaézi-Néjad ..... Ch. 5
- P. Haves - O. Bauman ..... Ch. 6.1
- D. Claridge ..... Ch. 6.2
- M. Jandon ..... Ch. 7- Appendix 2
- A. Akashi ..... Appendix 1

*under the supervision of J.C. Visier and M. Jandon.*



## 1. COMMISSIONING, WHAT IS IT? WHY DO WE NEED IT?

The demands of building users regarding the environment are growing. We all request a comfortable and healthy indoor environment but we do not accept any more excessive use of natural resources and pollution of outdoor environment. The energy consumption and the energy costs should indeed be kept on a low level.

The heating, ventilation and air conditioning (HVAC) industry seeks solutions to fulfil these higher requirements. Many new products and systems are developed such as high efficiency generation systems using renewable energy sources, low energy cooling systems, natural ventilation systems and integrated control systems... We are clearly leaving the time of low efficiency stand alone products and entering the period of high efficiency integrated systems.

Moving from simple products to large systems enables one to develop more efficient and flexible solutions, but leads to a higher level of complexity. Complexity for the building owner increases, who has to define more in details the Owner's Project Requirements (OPR). Complexity for the designer increases who has to design and define a full system on the basis of a growing number of attractive components. Complexity for the installer increases who has to install large systems which are all different, often innovative and have complex control and complex interactions. Complexity for the users increases who have access to more and more choices for the operation of the building.

The management of this complexity requires new approaches, new skills and new tools. Most of these were not available 20 years ago and are not yet taught at school.

Commissioning is one of the new approaches to manage the complexity of today's building and HVAC systems.

**Commissioning:** Clarifying building system performance requirements set by the owner, auditing different judgments and actions by the commissioning related parties in order to realize the performance, writing necessary and sufficient documentation, and verifying that the system enables proper operation and maintenance through functional performance testing. Commissioning should be applied through the whole life of the building.

Commissioning is performed under the supervision of a qualified CA for the purpose of ensuring that building systems are designed, installed and functionally tested, and are capable of being operated and maintained to meet OPR from viewpoints of environment, energy and facility usage. These viewpoints mean to maintain the indoor environment in healthy and comfortable conditions, to minimize the amount of energy consumed and discharged, to conserve the urban/global environment, to keep maintainability of the building systems and to give a long life to the building systems.

Commissioning will probably develop in the coming years for three main reasons.

- *Energy and environment reasons:* Global warming has increased the pressure to reduce energy use in buildings.
- *Business reasons:* Many companies are developing new services to diversify their activities in the building and energy industries. They see the commissioning as a way to develop new business for the *benefit* of their customers.
- *Technological reasons:* Building automation systems are now standard in new buildings and are being installed in many older ones. These systems automatically collect building and plant operating data and offer possibilities for *innovative* commissioning services.

The primary obstacles that impede the adoption of commissioning as a routine process for all buildings are clearly, lack of awareness, lack of time and too high costs. Hence, efforts for improvement should consider how new tools, methods and organizations can increase the awareness of commissioning, decrease the cost and demonstrate the benefits obtained by performing commissioning.

## 2. THE ANNEX 40 PROJECT

The Energy Conservation in Buildings and Community System programme of the International Energy Agency has supported for three decades projects to enhance the design and operation of buildings. In the 90's two successive projects were undertaken to develop fault detection and diagnosis tools and to implement them in real buildings. The goal was to provide building operators with tools to quickly detect faults which will occur in a building which formerly operates properly. Testing these tools in different buildings throughout the world leads all of us to the same conclusion.

*Most of these buildings have never worked properly!*

Getting tools to detect new occurring faults is important but it is even more important to commission the buildings to avoid initial faults.

This led to the decision to launch a new project in this direction. Two international workshops were organised in 2000 to define the best international approach to make progress in this field. Stimulated by these workshops a project called Annex 40 on "Commissioning of Building HVAC Systems for Improved Energy Performances" was launched for the period 2001-2004.

The objective of the Annex is to develop, validate and document tools for commissioning of buildings and building services. These tools include guidelines on commissioning procedures and recommendations for improving commissioning processes, as well as prototype software that could be implemented as stand-alone tools and/or embedded in Building Energy Management Systems (BEMS). The work performed in the Annex is focused on HVAC systems and their associated control systems. The impact of commissioning on comfort and energy consumption is the focal point of the work.

### Organisation

The Annex is organized according to the structure illustrated in Figure 1:

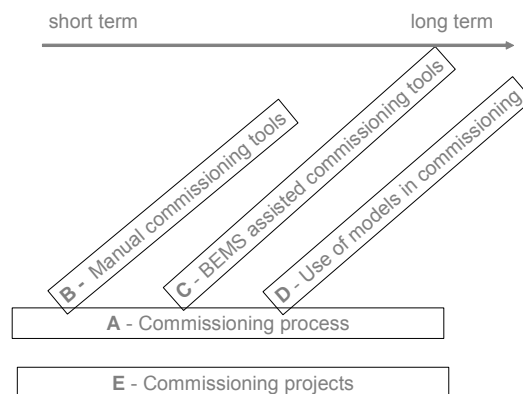

**Figure 1: Organisation of Annex 40**

### 2.1 TASK A: COMMISSIONING PROCESS

The first problem step in regarding commissioning is to select a commissioning organization which is adapted in terms of cost and benefit to the complexity and quality expectations of a given project.

From the experience of the different participating countries the Annex has developed a tool to help the developers of a given project select a qualified commissioning organization.

The different commissioning organizations are described in "Standard Models of Commissioning Plans".

These plans are then customized to describe examples of different national commissioning organizations.

A glossary has been completed to provide a common understanding of the terms necessary to describe commissioning activities.

## **2.2 TASK B: MANUAL COMMISSIONING PROCEDURES**

This subtask covered the transfer of manual commissioning procedures from country to country as well as the development of commissioning tools that can be applied without the use of a BEMS.

The strategy for this subtask consisted first in defining tools specifications then in transferring when possible procedures from one country to others. New tools are being developed, then tested in real commissioning projects and finally documented.

## **2.3 TASK C: BEMS-ASSISTED COMMISSIONING TOOLS**

BEMS offers new opportunities to automate some parts of commissioning. Subtask C included the development of an integrated set of commissioning tools using the existing capabilities of BEMS as well as tools for commissioning the BEMS itself. These tools are applicable mainly to commercial and institutional buildings.

The project first analyzed how BEMS are used today for commissioning and how the limits on existing commissioning procedures might be expanded through the use of BEMS. We defined then an efficient way for BEMS to access the data necessary for commissioning. The approach was used to define standard data for BEMS-assisted commissioning tests.

Prototype software enabling automation or semi-automation of Functional Performance Testing were developed using different approaches. The prototypes were developed sufficiently to be tested in real commissioning processes in collaboration with the envisioned users of the tools.

## **2.4 TASK D: USE OF MODELS AND COMMISSIONING**

The main objective of this subtask was to evaluate the feasibility of using computer simulation based on models to verify the performance of the whole building and its subsystems and components.

The first task was to review past and current efforts to use simulation models for commissioning.

The project then developed commissioning procedures using simulation models.

Simulation models were then applied at two different levels:

- component or subsystem level
- whole building level.

## **2.5 TASK E COMMISSIONING PROJECTS**

Each participant undertook at least one commissioning project and reported on the application of the tools developed within the Annex in these projects. This mandatory involvement of all partners in real projects enabled an in-depth interaction with potential users of the tools developed within the Annex. These projects served as the basis for the demonstration of the results of the Annex.

## 2.6 REFERENCES

Castro N., "Commissioning of HVAC Systems for Improved Energy Performance The Annex 40 Update", National Conference on Building Commissioning, Atlanta Georgia USA, May 2004.

Visier J.C., AIE-ECBCS, "Annex 40: Commissioning of Building HVAC systems for improved energy performance", 2001.

Visier J.C., "Developing tools to improve HVAC Commissioning", EPIC conference , Lyon, October 2002.

Visier J.C., "Commissioning of HVAC systems, the Annex40 Approach" , International short symposium on HVAC commissioning, Kyoto, April 8 2003.

Visier J.C., "Summary of Annex 40 results, ICEBO 2004 conference", Paris, October 2004.



### 3. THE COMMISSIONING PROCESS

In this section one explains first that commissioning shall be seen as a process, i.e. as a list of coordinated tasks which shall be performed in a structured manner. The different possible organisations to perform commissioning tasks as well as their pros and cons are then presented. Then three types of tools which can be used to structure the commissioning process are described and compared, they go from simple check lists to an extended matrix for quality control. Finally a short introduction is given to the document produced within the annex to describe the approach of commissioning in different countries.

#### 3.1 COMMISSIONING SHOULD BE SEEN AS A PROCESS

Commissioning is a quality-oriented process for achieving, verifying, and documenting whether the performance of a building's systems and assemblies meet defined objectives and criteria.

Commissioning too often is viewed as a task performed after a building is constructed and before it is handed over to the building owner to check operational performance. We clearly favour a broader view which starts at the pre design phase, goes through the construction process and continues during operation. This broader view aims at bridging the gaps between 4 different visions: the expectations of the building owner, the project of the designer, the assembled system of the contractor, and the running system of the operator.

Bridging these gaps will consist for example in:

- clarifying the expectation of the building owner to obtain the owner's project requirements so that the owner and designer understand one another and are in agreement,
- translating the project of the designer to specifications which can be understood and realized and verified by the contractor,
- applying functional performance testing procedures which will enable the contractor, the building owner and the designer to verify that the system is clearly operating as expected,
- producing system manuals which will enable the operator to take best profit of the ideas of the designers and of the system realized by the contractor to fulfill owner requirements,
- producing at regular intervals reports which will enable the operator and the building owner to check that the operation continues to fulfill these requirements.

In this broader view the Commissioning Process begins at project inception during the pre-design phase and continues for the life of the facility through the occupancy & operation phase. This global view aims at providing a uniform, integrated, and consistent approach for delivering and operating facilities that meet the owner's on-going requirements.

This broad view could appear to many users as a dream which could be realised in a few projects but which is too far from their day to day practice to be applicable to their projects. In practice one applies often only one part of the full process.

In practice one can differentiate 4 types of commissioning<sup>1</sup> which are represented on Table 1:

- Initial Commissioning (I-Cx) is a systematic process applied to the production of a new building and/or an installation of new systems.
- Retro-Commissioning (Retro-Cx) is the first time commissioning is implemented in an existing building in which a documented commissioning process was not previously implemented.
- Re-Commissioning (Re-Cx) is a commissioning process implemented after I-Cx or Retro-Cx when the owner hopes to verify, improve and document the performance of building systems.
- On-Going Commissioning (On-Going Cx) is a commissioning process conducted continually for the purposes of maintaining, improving and optimizing the performance of building systems after I-Cx or Retro-Cx.

---

<sup>1</sup> More information on these types can be found in APPENDIX 1: Glossary

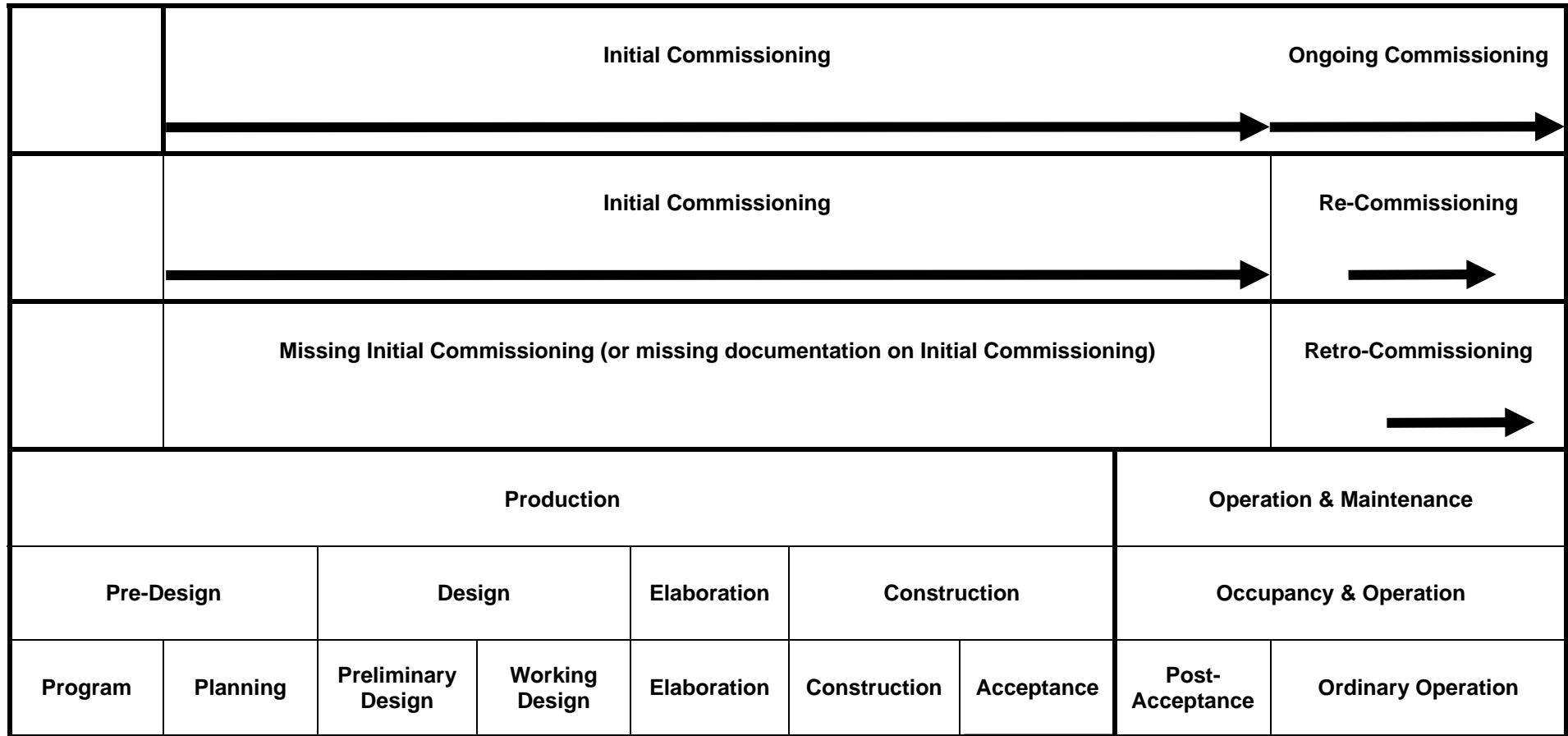

Table 1: The 4 different types of commissioning

An example of a generic commissioning process could be found in the Annex G of the public review draft of ASHRAE's proposed guideline 0, The commissioning process. It includes the following actions:

#### PRE-DESIGN PHASE

- Develop Owner's Project Requirements*
- Develop Initial Commissioning Plan*
- Commissioning Process Issues*
  - Step 1 - Identify and Record Issues
  - Step 2 - Calculate Avoided Costs
  - Step 3 - Evaluate Range of Avoided Costs

#### DESIGN PHASE

- Review and Modify Project Specifications*
- Verify Basis of Design*
- Update Commissioning Plan*
- Accomplish Design Reviews*
- Develop Commissioning Process Contract Document Requirements*
- Pre-Bid Meeting*

#### CONSTRUCTION PHASE

- Conduct Pre-Construction Meeting*
- Contractor Submittal Review*
- Construction Checklists*
  - Delivery Book
  - Pre-Installation Checks
  - Installation and Start-Up Checks
- Training
- Testing

#### OCCUPANCY AND OPERATIONS PHASE

- Final Commissioning Report
- Seasonal Testing
- On-Going Training
- Warranty Review
- Lessons-Learned Meeting

### 3.2 POSSIBLE ORGANISATIONS FOR COMMISSIONING

When the ultimate object of commissioning is considered, three main different organization for commissioning can be supposed and differentiated as follows.

In the first approach the commissioning tasks are performed by a commissioning authority which depends only of the building owner and which is fully independent of the other players in the construction process. This first approach insures that a new eye is looking at all aspects especially taking into account operation and maintenance issues. It gives a maximum security to the owner. The main disadvantages are the extra costs for this new activity and the risk of lower involvement of the other players in the quality aspects. Commissioning advocates consider that these costs lead to high savings and that the cost benefit ratio is very good.

This approach would only guarantee a commissioning as a series of processes to define and realize owner's project requirements from the program step to the post-acceptance step and hopefully through the lifecycle of a building, if well certified commissioning authority is directly hired by the building owner.

In the second approach commissioning tasks are performed by the usual players: architects, engineers, installers... This lead to a commissioning process much more embedded in the day to day practice of these players. The challenge here is to well differentiate the commissioning tasks from the usual design, installation, testing and balancing tasks. It is also important to make the building owner confident that these tasks are really performed.

This confidence could be obtained through a certification of the players by a third party. Different certification procedures can be used. For single family houses the certification can be a certification of the house itself. For larger project it is not manageable to certify the building which is the final product, process certification seems to be an efficient way to get confidence.

The third approach is an intermediate one and consists in having most of the actions performed by the usual players and to have a commissioning authority in charge of verifying that they are effectively performed.

In a long term view the two first approaches could lead to very different perspectives. With the first approach commissioning will become a work in itself with commissioning specialists. So the success of people working in the commissioning field would rest on having their work recognized by the market. In the second approach commissioning could become a part of each parties work as a way to improve quality. Commissioning work will in this second approach disappear as such and will only become common practice.

It is probably not possible to define which approach could be the best one. Depending of the national experiences, project size, owner wishes one approach or the other could be used.

### 3.3 TOOLS TO HELP STRUCTURING THE COMMISSIONING PROCESS

Whatever organisation approach is chosen, the key challenge to commission a building or system is to follow a well managed process. A central document for that purpose is the Commissioning Plan which defines the actions to be performed.

The Commissioning Plan is the key tool that gives the different players an understanding of what is meant by commissioning on a specific project, what amount of effort and money will be required and how it will be managed. The global content of this Commissioning Plan will be defined at the beginning of the project and will be refined all along the project.

Three types of tools were used within the Annex to support the definition and application of the Commissioning Plan. The following table gives an overview of these three types of tools:

<b>Tool</b>	<b>Description</b>	<b>Level of detail</b>
Standard Models of Commissioning Plans (SMCxP)	A typical description of commissioning actions during a project  To be used as a guideline to define the commissioning plan for a given project	Medium
Check lists	Minimum level of definition of a commissioning plan  Is specific to a given type of HVAC system	Low
Matrix for Quality Control (MQC)	An extensive tool for the management of the quality of the whole construction project.  Includes commissioning plan as well as other elements in a very structured way	High

**Table 2: Tools used in Commissioning Plans**

#### 3.3.1 STANDARD MODEL OF COMMISSIONING PLANS

These standard models include typical lists of tasks with a description of the content of each task. They can be used as a basis to define customized Commissioning Plans adapted to a given project.

Five standards models of Commissioning Plans are defined. The appropriate model can be selected by a risk evaluation (see Figure 2) which takes into account:

- Building size: The risk of malfunctions increases when one moves from small heated buildings to large air conditioned buildings.
- HVAC system complexity: HVAC packaged units designed to perform multiple functions to meet specifications which have been selected for a given building. Distributed systems such as hydronic heating system, centralized air conditioning systems are connected through air or water networks to constitute unique systems. The risk of poor design and installation is clearly higher with distributed systems, so they do require more intensive commissioning.
- The accepted risk level which depends on
  - The building owner and operator strategy: when the future user of the building is involved in the project from the beginning, the approach chosen to look at future operation of the building is often much more detailed. So the effort put in commissioning can be much more intensive.
  - Criticality of building operation: laboratories, computer centers, industrial and headquarter buildings are examples of buildings where malfunction may have high economic or image impacts. In such buildings the commissioning effort can also be more intensive than in other buildings.

The Standard Models of Commissioning Plans (SMCxP) documented within the Annex can be selected following the approach defined in Figure 2.

They correspond for example to the following cases:

- Type 1: small size building with simple HVAC system
- Type 2: medium size building with independent HVAC units
- Type 3: medium size building with simple HVAC system
- Type 4: large commercial building with centralised HVAC system
- Type 5: complex and/or critical building.

These SMCxP are available on the Annex CD Rom.

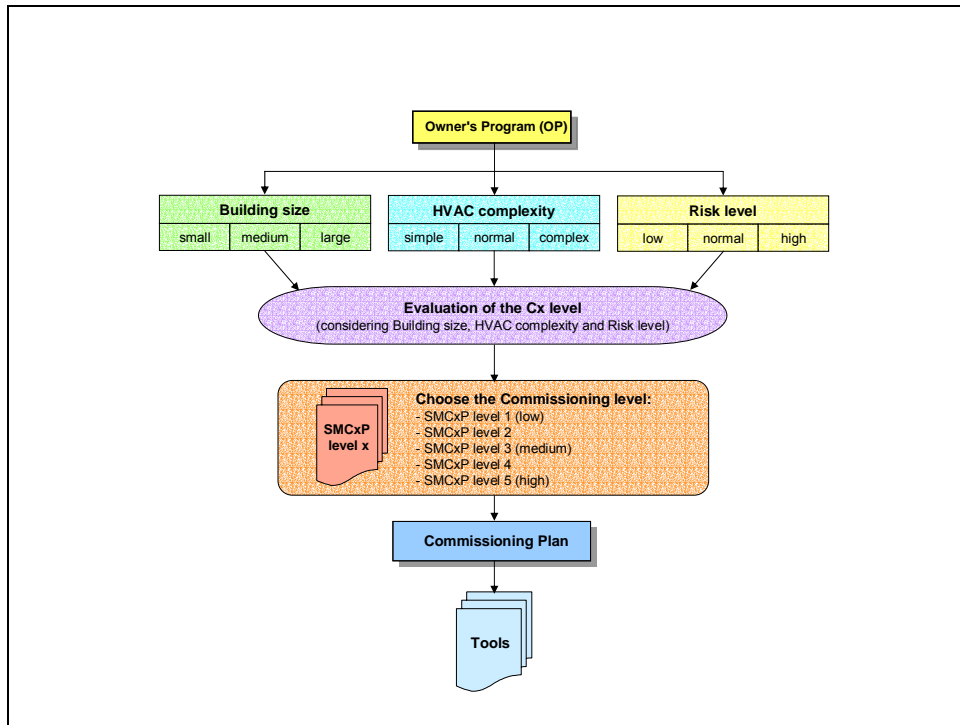

**Figure 2: Selection of the relevant Standard Models of Commissioning Plans**

<p><b>Pre-design</b>            Develop Owner's Project Requirements            Scope and budget for Commissioning            Appoint Commissioning Manager            Perform Risk evaluation            Develop initial Commissioning Plan            Identify functional Test requirements</p> <p><b>Design</b>            Write Commissioning specifications            Review Energy Budget            Elaborate Commissioning Members and Roles            Define Functional Test requirements            Elaborate Commissioning Plan            Review Design Docs for Sys Manual            Review Design Intent            Review Maintenance Management Needs            Review Phase Activities</p> <p><b>Elaboration</b>            Finalize Commissioning Specification            Update Commissioning Members            Develop Performance Forms            Develop Test Procedures and Forms            Review System Manual            Update Commissioning Plan            Review Phase Activities</p>	<p><b>Construction</b>            Update Owner's Project Requirements            Verify Test and Balancing reports            Develop detailed Test Procedures            Perform or verify functional tests.            Conduct Commissioning Meetings            Coordinate Commissioning Schedule            Update Commissioning Members            Refine Commissioning Forms and checklists            Review Submittals            Update Commissioning Plan            Verify Training            Review Phase Activities</p> <p><b>Operation</b>            Monitor operational benchmarks            Identify Warranty Action Items            Prepare Commissioning Report            Resolve Design/Construction Issues            Review Final As-Builts            Review Final System Manual            Training of Owner's operation and maintenance personnel            Identify Unresolved Issues            Final Commissioning Report</p>
---	--

**Table 3: Example of a Standard Models of Commissioning Plans for a medium size building with simple Heating and Ventilation system**

### 3.3.2 CHECKLIST

The minimum version of a Commissioning Plan is a checklist defining the verifications to be performed all along a projects process to ensure that critical actions were effectively performed.

The key advantage of the checklist is its simplicity. There would be no need to use a special software or for in-depth training of the users. The main disadvantage is that it defines what to do but not how to do it and does not include a documentation of the results obtained.

In these simple projects, where an independent commissioning authority generally will not be involved, the checklist enables the project manager to apply a minimum of quality control. Checkpoints are especially important when proceeding from one project phase to the next. These checklists will be used by each party involved in the project.

The CD Rom contains examples of checklists developed in different countries. Since effective tools and practical checkpoints vary from country to country: it is recommended that each country design its own set using the examples as references.

### 3.3.3 MATRIX FOR QUALITY CONTROL

Matrix for Quality Control (MQC) matrix was initially developed in the Netherlands as a tool for the overall quality control of climate control Climate Installations. In the Netherlands the MQC structure has been elaborated for heating systems and domestic ventilation systems (Ramsak 2001).

Its intention is to control the total production process including specifications, design, construction, hand-over and operation. It focuses on avoiding failures on all strategic aspects and phases in this process.

The most important characteristic for MQC for HVAC systems is a structure that follows through all the process phases.

This enables planners to build in a number of strategic decision points in the building and system process and to assess if a system meets the targets and requirements, as defined in the program phase. The total quality required is determined by several aspects (not only technical but also financial, organisational and communications).

This leads to a so-called quality control matrix. On the horizontal axis of the matrix, the phases of the process are distinguished. On the vertical axis of the matrix, distinguished quality control elements are listed.

In the original Dutch Matrix different quality control aspects are discriminated as shown on Table 4.



0 General	Description of the general objective(s) of each phase including the starting points, boundary conditions and points of particular interest.
1 Organisation	Description and allocation of tasks and responsibilities.
2 Communication	Description and recording of the necessary information exchanges among all parties involved in the process is reported including a description about the necessary consultations including which parties, when the objective and deliverables of each consultation.
3 Requirements	Inventory of internal and external requirements including a base level of legal requirements such as buildings regulations, standards and others as well as recommendations, according to (higher) quality level.
4 Means	Listing of all necessary calculation methods, execution protocols, assessment and evaluation tools including references to standards (like calculation, determination and measurement methods) measurement instruments and literature.
5 Purchase	Description of necessary external expertise that has to be purchased.
6 Time	Guarding of the object planning as well as process planning.
7 Finances	Controlling and guarding of the object costs (i.e. HVAC installation) as well as the process costs (co-ordination, consulting, commissioning).
8 Documentation	Reporting of the input and output of all sequencing phases.
9 Experience	Evaluation of the process at the end of the phases.

**Table 4: Aspects considered in the Dutch MQC matrix**

Indeed this matrix was developed as a quality control tool which does not require the use of an independent commissioning authority. The commissioning tasks are then not highlighted.

During the Annex a new vision of the MQC matrix was developed by the Japanese team as a tool to define the commissioning process. This new tool called MQC\_JP is used to define most of the necessary procedures required for the commissioning authority as well as commissioning related parties during the production stage and the operation and maintenance stage (Nakahara 2002).

The MQC\_JP matrix was created using Microsoft Excel™. The tool provides a typical matrix which can be customized to the specificities of any given project.

The Excel tool is designed to enable the storage of a very large number of data as well as an easy navigation. The first sheet enables the navigation between the different phases of a project and the different quality aspects.

Commissioning Matrix		Production Stage						
		Program Phase (Pre-Design Phase)		Design Phase		Elaboration Phase	Construction Phase	
TYPE IV ~ V Non-Residential Building		Program Step	Planning Step	Preliminary Design Step	Working Design Step	Elaboration Step	Construction Step	Acceptance Step
Aspect	Definition	Phase Keyword						
		Phase Definition						
		Step Definition						
		CA's Role						
	Actions							
	Organization							
	Requirements	Standards/ Regulations						
		Performance/ Criterion						
	Commissioning Tools	Documentation Tools						
		Technical Tools						
	Purchase/ Finance	Purchase (outsourcing, hiring)						
		Funding						
	Outcome/ Documentation							
	Others							

Figure 3: MQC\_JP Matrix

Clicking on one of the cells gives access to a subject sheet which includes definitions as well as a listing of all included subjects.

Commissioning Matrix		Preliminary Design Step	
Roman letters: CA 's role, action and Cx related events			
Italic letters: Principal players ' role, action and Cx related events among Cx Related Parties during the			
Standard Model Commissioning Plan			
Detailed Preview	TYPE IV - V Non-Residential Building	Preliminary Design Step	
49	Standards/ Regulations	Building Code and Regulation	
50		Fire Code and Regulation	
51		Public Building Regulation (Green Building)	
52		Energy Conservation Regulations	
53		JIS (Japanese Industrial Standard)	
54		ISO	
55		JASS/HASS (Academic Standards for Architecture and HVAC)	
56		Licenses and Intellectual Property	
57			
59		Requirements	Indoor Environmental Criteria (IAQ, VOC)
60	Economical Performance (First/C, Operating/C, Life Cycle C)		
61	Environmental Load(CO2, Waste, Energy)		

Figure 4: "Subject" sheet in the MQC\_JP matrix

Clicking on one of the displayed subject cells will give access to the detailed input sheet. This sheet can include specifications, links with required documents, documenting formats/templates with technical tool information or to a tool itself. Links can be easily established to reference files, URL files and mail addresses. The goal is to enable an easy access to the information for the commissioning process.

MQC can grasp the whole nature of the commissioning work in production and operation and maintenance stages, and it becomes easy to check required actions and obtain necessary information. This structure is not always convenient to look at in the printed form because of its multi-layer structure and the huge and varied contents of commissioning information covered. After a minimum training, the Excel tool enables an easy access to all this information.

### 3.3.4 EXAMPLE OF THE APPLICATION OF DIFFERENT TOOLS TO SPECIFIC PROJECTS

#### ***SMCxP Fr***

France is developing customized versions of the SMCxP for medium-size buildings such as schools and small office buildings.

The tools developed are based on an access database which enables practitioners to store information throughout the project.

The first stage enables users to:

- clarify owners project requirements regarding the HVAC system;
- collect design information to check if the topology of heating and ventilation system is correctly adapted to the planned operation;
- check the proper application of procedures selected for the dimensioning of the system and its components.

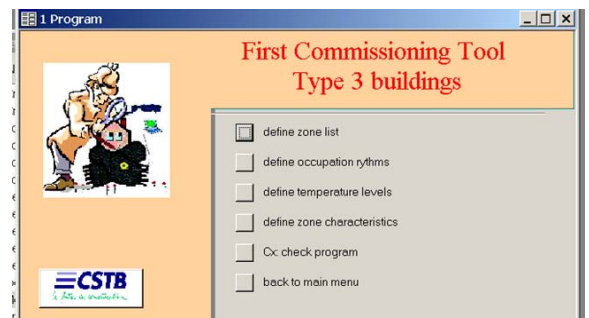

Data collected during pre-design, design and elaboration phases are stored and are then the basis for the application of commissioning during the construction phase. During this phase, the tools make it possible:

- to follow up testing and balancing
- to select and apply Functional Performance Testing procedures to be applied for a specific project, and
- to document the results obtained

During the occupancy & operation phase, the tool makes it possible to define and apply optimization procedures.

#### ***MQC\_JP***

The Standard Models of Commissioning Plans and MQC\_JP generic matrix can be customized to apply to different types of commissioning projects.

The MQC\_JP was customized in Japan for residential ventilation. The matrix obtained is applicable to many different projects. A standard matrix was also developed for complex non residential buildings. It was then used as a starting point to develop a matrix adapted to a specific construction project.

These two examples are presented below.

#### **3.3.4.1.1 MQC\_Jp for Residential Ventilation System**

It is a requirement to install ventilation equipment in every house in Japan according to the Building Standard Law. The law requires a ventilation unit that can exchange the indoor air 0.5 times per hour. Although it became an obligation in 2003, architects and equipment constructors are not accustomed to the law or to practical mechanical ventilation systems. The MQC\_JP matrix for residential ventilation systems was developed to give them the exact information they need at every step of the production stage.

For example, it may assist them in finding laws, standards and regulations that can be applied during the planning step or design step. They also may find useful tools and information during the elaboration step, as well as the latest information on technical tools available for ventilation performance measurement.

The full matrix developed in Japan is available on the CD. Other countries can use it as an example to help them develop specific matrix adapted to their national context.

#### **3.3.4.1.2 MQC\_JP for complex non residential buildings**

The MQC was applied for the first time in Japan to a complex non-residential building in Tokyo in 2000. The commissioning authority was invited to participate as an independent party. The commissioning process started at the beginning of the construction phase when the owner was enlightened about the commissioning concept. This corresponds, then, to a partial initial commissioning by definition.

The full MQC matrix developed is available on the CD.

The documentation and process itself were performed primary based on the knowledge obtained from the ASHRAE guideline for the commissioning process (1996 version). Self-developed tools were added for documentation as well as for testing over the commissioning process from the construction phase to the post-acceptance phase. The Commissioning Plan was effectively performed.

Some knowledge drawn from the experience is as follows.

- The merit of using MQC\_JP customized to a specific project

As the horizontal axis of MQC\_JP sets for the project schedule, the commissioning managing team and the commissioning related parties can refer to and confirm the owner's project requirements (OPR), design intent, and the cause and history of any modification at later phases, if the commissioning process began at program phase and the matrix were to be used. Misunderstanding and faults caused by miscommunications might be prevented easily. Also, as templates for documentation are listed in the table of contents in MQC\_JP, considerable savings in cost and time can be realized.

- Issues disclosed during the process of following post-structured MQC\_JP matrix

The importance of design commissioning was recognized for all parties. The Basis of Design, Design Intent document and Guide for System Control and Operation, which would have been provided from OPR, were not available. This result in the enormous obstruction to works to be done by the commissioning team at later phases.

These documents should define control schematics, equipment parameters and energy target values as detailed as possible in addition to the performance indices such as energy use, environment performance and thermal condition. Unless these indices and conditions are defined at the design phase, the construction and acceptance steps of commissioning might fail because the Commissioning Authority could not judge whether any test results would pass or fail. Therefore, those values should be decided at as early a phase as possible.

An example is shown when the Commissioning Authority raised a question about chiller performance at the beginning of the construction phase, but construction continued without a satisfactory answer and was completed. Then the chiller was found to have insufficient power in the functional performance testing during the acceptance and post-acceptance steps. The example shows the importance and necessity of clarifying any existing problems as early as possible and solving them at that time.

- Expectation to MQC\_JP

The MQC\_JP is recognized as very useful as the process control and document management tool with standard process model and documentation templates throughout the project. If the MQC\_JP tool provided a data access function from multiple PCs, this tool would become more useful. This simultaneous input function may lead to more effectively to documentation.

- Functional Performance Tests in this project

MQC\_JP is an useful approach to specify, perform and document Functional Performance Tests. The MQC\_JP provides an overview of the Functional Performance Tests in this project. The following scheme shows how these tests and their results appear in the matrix.

The screenshot displays two overlapping Excel windows. The top window shows a 'Commissioning Matrix' with columns for 'Phase' (Acceptance Step, Post-Acceptance Step, Post-Post-Acceptance Step) and 'Operation & Maintenance Stage' (Operation Phase, Occupancy and Operations Phase). It lists various tools like 'Documentation Tools', 'Commissioning Tools', and 'Communication Tools'. The bottom window shows a 'cell contents data' table with columns for 'cell contents', 'specification', 'aspect(Feature2)', 'URL', 'MAIL', and 'Other Files'. Below the table is a graph titled '三方弁制御 2000-10-13 21:00 ~' showing temperature (温度(°C)) and flow rate (三方弁出力%) over time. The graph includes data series for R-1 inlet temperature, R-1 outlet temperature, control room temperature, control room temperature (dotted), and R-1 3-way flow rate.

cell contents	specification	aspect(Feature2)	URL	MAIL	Other Files
Open test	Active test	Pump flow volume			Pump flow volume.doc
Diode test	Active test	Heat exchanger ability			Heat exchanger.doc
Diode test	Passive test	3 way valve control			3way valve control.doc
Open test(Partial closure)	Active test	REP protection control			REP protection.doc

Figure 5: Subject sheet and Test of a three way control valve.



### 3.4 LEARN MORE ON DIFFERENT COUNTRIES APPROACHES

Apart from the common work performed in the Annex, the Annex participants have analysed the way commissioning is performed or could be improved in different countries. The following documents will enable the interested reader to know more about the development of commissioning in different countries.

#### Norway

Hoel et al. (2003a, 2003b) summarized status of commissioning in Norway. Hoel et al (2004) describes how manual methods for partial initial commissioning can be implemented during the elaboration and construction phases. Novakovic et al (2004) made a survey of Norwegian Energy Efficiency Methods (Re-Cx) and comparison to the continuous commissioning process.

#### Switzerland

Chuard (2001) describes the standard and regulation applicable in Switzerland which have an impact on the commissioning activities. Chuard (2004) made a survey of a methodic approach to increase the energy efficiency in Buildings in Switzerland. Chuard (2003) describes the principles and the methodic approach for a risk evaluation. Chuard et al (2003) describes the basic principals for optimum operation of complex installations (OCI). Chuard et al (2003) describes cost-efficiency arguments for optimum operation of complex installations (OCI). Chuard et al (2003) describes the sensitivity of decision procedure for optimum operation of complex installations (OCI).

#### Japan

Nakahara (2004) overviews activities of commissioning development in Japan and the Asian countries comparing that of US and of UK and describes activities done on development of tools in Annex 40. Nakahara (2003) describes established complex of commissioning process in the view of works in Annex 40 and Japanese committee on commissioning guideline. Nakahara (2001) Describes commissioning activities on producing basic commissioning guideline and some experiences on initial commissioning and continuous commissioning processes.

A commissioning guideline is developed by SHASE (SHASE 2004)

#### Hong Kong

Apart of the Annex 40 but in a workshop organised in connection to it, Wong (2003) presents a perspective of commissioning development in Hong Kong.

#### Sweden

The commissioning process in Sweden as described in Eriksson (2001) used to be focused on acceptance tests during the handover. Usually only some few performance tests were realised. The "Commissioning Agent", a group of persons hired by the owner of the building, inspected the building to check that the installations were complete.

Nowadays the "Commissioning Agent" takes part in an earlier stage of the realisation phase and thus has a larger possibility to control the system quality (Isakson 2002). The commissioning process in Sweden is moving towards realistic tests of the performance of complete systems.

For residential buildings, a quality control system has been a reality in Sweden since 1989, developed by SP, the Swedish National Testing and Research Institute (Sandberg 2001). It is a voluntarily system that includes prefabricated buildings.

## USA

The City of Oakland, CA, embarked on a novel new energy efficiency performance contract project in 1994 on two new buildings. The resulting buildings were relatively energy efficient, but inadequate data collection, the oversizing of equipment and poor operation and maintenance practices significantly reduced energy savings (Moteji 2003). The costs and benefits of commissioning are analyzed for programs in the Pacific Northwest (Oregon, Washington, Idaho and Montana), California and New York (Dodds 2003). The driving factors for U.S. commissioning programs are described, including Codes and Standards, utility-based programs, the LEED (Leadership in Energy and Environmental Design) and California and New York programs (House 2001.). An overview of U.S. commissioning activities is presented, giving primary attention to existing buildings (Claridge 2003.).

Different commissioning guidelines were already developed or are under development especially by ASHRAE (ASHRAE 2005, ASHRAE 1996)

## France

Visier (2001) a gives an overview of the French commissioning process. Visier (2001b) describes the documents and approaches for the commissioning of ventilation systems. Vaezi Nejad 2001 presents the main problems with commissioning of hydraulic heating systems.

## Germany

Schmidt (2001) presents a synthesis of the German Commissioning process for HVAC system.

## Finland

Nystedt (2002) presents a survey of commissioning methods used in Finland.

## Netherlands

Ramsak (2001) presents the matrix for quality control which is used in the Netherlands and its possible use for the commissioning of HVAC systems. Ramsak (2002) presents the relative positioning of commissioning, quality assurance and certification.

## United Kingdom

A series of commissioning guidelines are developed by CIBSE (CIBSE 1996, 2001, 2002, 2003).



### 3.5 REFERENCES

Akashi, Castro, Novakovic, Viaud & Jandon, "The IEA/ECBCS/Annex 40 Glossary on Commissioning", ICEBO, Paris, 2004.

ASHRAE, 1996, "The HVAC Commissioning Process", ASHRAE Guideline 1-1996.

ASHRAE, 2005, "The Commissioning Process", ASHRAE/NIBS Guideline 0-200x (to be published).

Chuard, J.M., 2001 "Standards and regulations in Switzerland influencing the Commissioning practice", A40 A2 CH ECH1 A40-A-2-CH-ECH-1.

Chuard, J.M., 2003 "Basic principals for optimum operation of complex installations (OCI)" A40-A-M6-CH-ENC-1.

Chuard, J.M., 2003 "Cost-efficiency arguments for optimum operation of complex installations (OCI)" A40-A-M6-CH-ENC-3.

Chuard, J.M., 2003 "Risk evaluation the answer on which level Commissioning must be performed" A40-B1-M5-CH-ECH-1.

Chuard, J.M., 2003 "Sensitivity of decision procedure for optimum operation of complex installations (OCI)" A40-A-M6-CH-ENC-2.pdf.

Chuard, J.M., 2004 "Energy efficiency in buildings in Switzerland", ICBE0 , Paris, 2004.

CIBSE guides:

CIBSE Commissioning Code A: Air Distribution Systems, 1996, ISBN 090095 373 X;

CIBSE Commissioning Code B: Boilers, 2002, ISBN 1903287294;

CIBSE Commissioning Code C: Automatic Controls, 2001, ISBN 1903287138;

CIBSE Commissioning Code M: Management, 2003, ISBN 1903287332;

CIBSE Commissioning Code R: Refrigeration, 2002, ISBN 1903287286;

CIBSE Commissioning Code W: Water Distribution Systems, 2003, ISBN 1903287391.

Claridge D, Commissioning of Existing Buildings - State of the Technology and It's Implementation, Kyoto symposium, 2003.

Dodds D, Commissioning cost/benefit Current approaches in US programs A40 A2 M5 US CH2M, 2003.

Eriksson J., Commissioning process in Sweden, A40 A M2 SE SP 1, 2001.

Hoel, Novakovic, Holst, 2003b, "Survey of best practice initial commissioning and potential for introducing on-going commissioning in building and construction industry in Norway" A40-A-M6-NO-TIH, 2003.

Hoel, Novakovic, Skjulsvik, 2004, Implementation of partial initial commissioning during the elaboration- and construction phase, ICEBO, Paris, 2004,.

Hoel, Novakovic, Stang, 2003a, "Norwegian National Report on Commissioning Activities" A40-A-M6-NO-SYNTEF-1, 2003.

House J, Commissioning in US, Market and driving factors A40 A M2 USA IEC 1, 2001.

Isakson P., Commissioning of Kista Entre, A40 E M3 SWE AF/KTH 2, 2002.

Motegi N., Piette M.A., From Design Through Operations-Results from New Construction Performance Contract and Beyond, Kyoto Symposium, 2003.

Nakahara N, National report on Commissioning activities A40 A M1 JP NESTEC 1, 2001.

Nakahara & Kamitani, Commissioning process on modified MQC, Content and functions, Kista, 2002.

Nakahara, N, International background and domestic activities on Commissioning , Kyoto, 2003.

Nakahara, N, "Japanese version of Commissioning process", ICEBO, Paris, 2004.

Novakovic, Stang, Skjerven and Holst, 2004, Comparison between the Continuous Commissioning<sup>SM</sup> process and methods used for energy efficiency in Norway, proceeding paper 57, ICEBO, Paris, 2004.

Nystedt A et al, Commissioning methods used in Finland, a survey A40 A M3 FI VTT TUT 1, 2002.

Onojima & Kamitani Defining SMCP using MQC as a tool for Commissioning process (PPT), M5, 2003.

Onojima & Kamitani Demonstration of the newest version for SMCP\_Type4,5/MQC\_JP and final goal, (PPT), M6, 2004.

Ramsak P., Op't Veld P, Model Quality Control for Commissioning of HVAC, A40 A1 NL CH1 MQC Ramsak Op't Veld, 2001.

Ramsak P., Positioning on Commissioning, QA and certification , A40 A M3 NL Novem 1 (slides) Ramsak slides, 2002.

Sandberg M., Eriksson J, Commissioning of residential buildings in Sweden A40 B1 M2 SE SP1, 2001.

Schmidt M., Grob R., Synthesis of the German Commissioning process for HVAC system A40 A M1 GER IKE 1, 2001.

SHASE 2004 "Commissioning guideline for building services systems". SHASE. March 2004 (In Japanese).

Vaezi Nejad H., Commissioning of hydraulic heating systems in France A40 B2 M2 F CSTB 2001.

Vaezi-Nejad H., et. Al 2003 Approach for the improvement of energy performance of a stock of buildings, ICEBO, Paris, 2004.

Visier J.C., a French Commissioning Process A40 A M2 F CSTB 01, 2001.

Visier J.C., Jandon M. and Vaezi Nejad H., SMCxP and associated tools for a type 3 buildings, Slides, Kista, 2002.

Visier J.C.2001b Commissioning and Commissioning tools for ventilation systems A40 B1 M2 F CSTB 01, 2001.

Wong C.F., Building commissioning- A Perspective and development in Hong Kong, Kyoto workshop, 2003.

## 4. FUNCTIONAL PERFORMANCE TESTING (FTP)

### 4.1 INTRODUCTION

Many actors around the world have already developed some performance procedures. The main challenges today consists in making the best use of *existing* procedures adapted to national building industry and contract standards, and only develop new ones when required.

Annex 40 strategy consisted in specifying the commissioning process and the tools actually required for the application of each commissioning plan, in addition to transferring existing procedures from one country to another one and in developing new required procedures.

The main information sources were localized, among them in US, where an important data base is available (Haasl et al, 2002), (Haasl et al, 2003). This source was very much used in the frame of Annex 40.

Each component has a well defined function inside the whole HVAC system. Any malfunction can compromise the correct behaviour of the whole system.

The malfunction may be due to:

- Design faults
- Selection or sizing mistake
- Manufacturing fault or initial deterioration
- Installation fault
- Wrong tuning
- Control failure
- Abnormal conditions of use.

The functional performance testing (FPT) is devoted to the detection of such possible malfunction and to its diagnosis.

The test can be “active” or “passive”, according to the way of analyzing the component behaviour: with or without artificial perturbation.

Active tests are mostly applied in initial commissioning, i.e. at the end of the building construction phase.

Later in the Building Life Cycle (BLC) (see glossary), i.e. in re-, retro- and on-going Commissioning, a passive approach is usually preferred, in order to preserve health and comfort conditions inside all the building occupancy zones.

After having defined the different audiences concerned (§4.2), this chapter is presenting a global vision of FPT (§4.3), with selection of a preferred strategy (§4.2.1) and with attention to the integration of FPT in the whole commissioning process (§4.3.2).

A generic description of a FPT is then presented (§4.4), including:

- A description of the system, subsystem or component considered (§4.4.1);
- A presentation of the testing procedure (§4.4.2);
- Some additional possibilities (model use and possibility of automation (§4.4.3).

A detailed list of FPT specifications developed in this Annex is then presented and commented (§4.5). Links are established with the documents contained in the CD-ROM.

In residential buildings, the performance of the systems for ventilation and heating is more closely related to the characteristics of the whole building than in non-residential ones. Furthermore, only a manual commissioning is common, usually made by residents themselves. It's also typical in the residential sector that each component is working almost independently from other ones. This is why FPT procedures adapted to residential buildings are described separately (§4.6).

A list of other FPT sources and bibliographic references is also given at the end of this chapter (§4.7).

## **4.2 THE DIFFERENT AUDIENCES**

The following explanations are addressed to different audiences:

- *System Designers*, who should recommend, justify and describe the required FPT in their *Design Documents* (but still today in too many project, the system designers only specifies that FPT shall be performed, and the contractors have to describe the FPT, which has to be approved by the system designer);
- *Manufacturers*, who should contribute a lot into FPT preparation, because of the information they have about the actual characteristics of their products and also because they could make easier the instrumentation of their components, or even incorporate in them some of the sensors required;
- *Installers and Commissioning Authorities* (if they are distinct actors), who have to perform the test together with other relevant parties, like system designer, clerk of work etc;
- *Managers*, who are designated to run the HVAC plant;
- *Building owners*, who should be convinced of the usefulness of the tests.

## **4.3 A GLOBAL VISION OF FPT**

### **4.3.1 WHICH LEVEL TO CHOOSE**

A FPT can be realized at different levels involving:

- The whole system
- A subsystem, involving several components
- Components that are considered as critical, considered alone.

The level choice should be made on the basis of a risk analysis and in relationship with acceptance criteria. This choice depends on the questions to be answered and on the variables which can be accessed and measured.

### ***Top- down and bottom-up approaches***

A first approach consists in “going down” from the “system” level to the component “level”, passing through some subsystems.

The whole system functional performances are first verified and the inquiry is extended to lower and lower levels, according to observed malfunctioning and to questions to be answered.

The final goal is not to verify if a component is “good” or “bad” in itself, but to check if it’s correctly integrated in the system considered.

There is a specific risk associated to the top-down approach: some energy-wasting situations could be missed. A system can appear to perform fine, as far as meeting comfort and health needs, but there may be faults in individual components.

For example, a poorly-tuned control may cause an AHU to cycle between heating and cooling. If the zone temperature doesn’t vary too much and stays very near to its set point, the problem might not be apparent. Such faults may be found at the system level only, if the waste is great enough to be obvious when compared with expectations.

The “bottom-up” approach, consists in starting from an elementary component and going back progressively to the whole system. It might be more appropriate for initial Commissioning, in order to follow the construction (not to arrive too late). It allows a safer identification of local defaults, but it might also generate a waste of efforts by lack of global vision of the problem.

### ***“Upstream” analysis***

When a system malfunctioning is observed, a good strategy consists in going “upstream”, from the malfunctioning observations (for example a too high zone temperature) towards the “source” (for example the cooling plant), passing through intermediate subsystems and components (for example the air distribution network and the air handling units).

Such a strategy should allow the commissioners to identify the main “bottlenecks” of the system (for example the reasons why the zone considered is not cooled enough).

### ***Priorities***

It’s on the BEMS itself that the very first FPT have to be applied (with special attention to the *measuring* subsystems associated: sensors, wiring, signal converters and data storage).

Priority attention has also to be paid to the components usable as “measuring devices” (with or without on side calibration): valves (also expansion valves), registers, pumps, fans, compressors, etc. (cf. § 6.1).

### 4.3.2 INTEGRATION OF FPT IN THE COMMISSIONING PROCESS

FPT is just one part of the whole Commissioning process. It has only to be started on the basis of strict specification, given in the *Design Documents*); the test results and interpretation have to be incorporated into the *As-built Records*. All information sources should be used in order to guarantee a successful FPT.

Verification checks are also an important prerequisite to functional performance testing. In the field, verification checks are often referring to as pre-start checks, start-up checks, or pre-functional tests. Regardless of the specific terminology used, these items consist of necessary checks prior to activating a system or immediately subsequent to its activation, to ensure that it is safe to operate and ready for the more rigorous processes associated with a functional test.

Typical examples of this type of check include :

- Verifying that the component actually installed is the component described in the As-Built records;
- Verifying piping and wiring connections;
- Verifying calibration and sensor locations;
- Verifying safety settings;
- Flushing and static pressure testing of piping systems;
- Verifying belt tension;
- Verifying electrical parameters like voltage and amperage;
- Verifying pressure and flow ranges for utility and support systems...

But the very first verification should consist in making sure that the HVAC components actually installed are those described in the AS built files.

In initial commissioning, this means that all components datasheets, containing all operational and maintenance information, have to be delivered before installation.

### 4.3.3 FPT BASIS

#### ***Understanding the fundamentals***

To be truly successful in the commissioning arena, it is essential to understand the background behind how the system will respond to a test, as well as what could be causing the observed responses.

#### ***System concept***

Information and testing procedures are viewed from a system perspective, rather than a component perspective. This is especially critical for functional performance testing and for the overall success of the system. The performance of the system is dependent on four areas of interaction:

- The individual components in the system
- The components with each other as a subsystem
- The subsystem with other subsystems in the building
- The building with its environment.

## 4.4 DESCRIPTION OF INDIVIDUAL FPT

One of the Annex 40 “products” is a general specification format (hereunder presented), which can be applied to the whole system, or to any part of it (including the building itself and its HVAC equipment).

Each FPT specification developed in the frame of annexe 40 contains at least a part of the items presented hereunder.

### 4.4.1 PRESENTATION OF THE SYSTEM (OR SUBSYSTEM) CONSIDERED

#### ***Operating principles***

This first item consists in a recall of basic principles (according which the system has been designed), working principles, expected performances, calculation methods and simulation models (used in the design), emergency procedures, interaction with other (sub)systems and corresponding building service area(s).

That information should be made available in the As-Built Records.

#### ***Manufacturers Data***

HVAC components manufacturers publish technical sheets and performances data sheets, including maintenance information.

These sheets are also supposed to be available in the *As-Built Records*.

#### ***Problems to be considered***

Most relevant malfunctioning cases have to be listed, in relationship with occurrence risks and practical consequences in the case considered (risk analysis).

Performance uncertainties (as predicted by simulation) have to be specified, as well as (simulation predicted) sensitivities of these performances to:

- Conditions of use;
- (Lack of) maintenance;
- Aging
- Etc...

### 4.4.2 THE TEST ITSELF

#### ***Summary of the test specification***

This summary intends to make FPT objectives well understood by all partners. It includes the following items:

#### **Objectives and test sequence.**

The different testing phases are here recorded with verification objects and expected results.



## **List of verification points, experimental conditions and acceptance criteria.**

Specific operational points, test conditions and acceptance criteria should be defined on the basis of some preliminary simulations.

These simulations can be performed with existing models, having been previously used by Designers, Manufacturers and Installers, and/or with some “adapted” models, as those presented in chapter 6.

### **Equipment required**

### **Time required**

### **Preliminary operation required**

### ***Preparation phase***

### **Evaluation of data available and of expected performances**

A FPT can be performed at any time, all along the building life cycle. The starting point is an evaluation of all information and data actually available at the time considered (in the corresponding BLC phase).

Performance criteria have to be fixed in accordance with that information. It would be indeed illusory to pretend verifying any performance, which couldn't be predicted or evaluated on the basis of the information available.

The evaluation concerns:

- the measuring and control points already installed which could be used for the test;
- the actuators performances;
- the experimental design and the measuring and techniques;
- the technical documents issued from the designers (including design goals and relevant parameters, having to be passed on to the construction phase);
- the documents supplied by the contractors (including sizing calculation);
- the laboratory testing results (if any);
- the preliminary (visual) verification records;
- the previous commissioning test report (if any).

## **Preparation of the complementary instrumentation.**

This instrumentation concerns:

- HVAC equipment;
- some reference building zones;
- the outside weather (meteorological station).

The "preparation" may also include some adaptation of the BEMS data logging and storage system, in accordance with the relevant variable to be collected.

### ***The test method.***

#### **Summary of the test method**

Each method has to be selected and validated on the basis of a theoretical analysis.

Its description includes the following items:

- Operational Conditions and Time required to conduct the test.
- Measuring Techniques and Instrumentation required (using BEMS sensors, as well as movable equipment and other components already calibrated).
- Pre-requisites (i.e. what needs to be achieved in the whole building and HVAC system, before verifying the performances of the system or component considered).
- Data pre- processing ((cross-checking, filtering, curve fitting, etc): simple mass and energy balances can be used to check the measuring consistency. First principle (static and dynamic) models (cf § 6) are used for measurement cross-checking: fluid flow, pressure, mass, momentum and energy balances and transfer laws, in steady state and transient regimes. The checking consists in verifying if space and time variations observed (from one sensor to another one and on a same one, from time to time) make sense. The pre-processing of measurement data also consists in visualizing the time and space distributions, thanks to plots and system pictures. At the end, the relevant variables are calculated (in time average and/or in filtered time variation) from the best combinations of all information collected. These variables are re-conciliated among themselves, thanks to hierarchical choice among redundant data...
- Data processing and result analysis.

The content of each FPT report is structured in such a way to make easier any further FPT. This report should present a results synthesis to be included in the *As-Built Records*.

#### **4.4.3 ADDITIONAL POSSIBILITIES**

##### ***Model calibration and use of some components as "measuring devices"***

Many HVAC components have sufficiently well known characteristics in order to be used as measuring devices. Manufacturers themselves are very often offering adapted sensors or adapted location for such sensors as part of their products.

This is particularly true for *control valves, refrigeration expansion valves, compressors, pumps, registers and fans*.

These components are usually offered (in option with moderated extra-cost) with well-prepared pressure probe locations.

Pressures measured at these locations are used to determine the corresponding flow rate, for each position of the control device (*valve or register opening, pump or fan rotation speed...*).

If the [pressure, flow rate] curve of the pump or of the fan is too “flat”, it can be replaced by another one, with relationship to the electrical power (or the electrical current) consumed.

Other “good candidates” to become measuring devices are all HVAC components having been previously tested in laboratory and/or for which calibrated simulation models are already available.

A few on site calibration tests might be sufficient to guarantee a good enough accuracy. Such tests are required if the location of the sensors is not fully satisfactory.

### ***Possibility of Automation***

This is developed in chapter 5.

## 4.5 FPT SPECIFICATIONS DEVELOPED IN THE ANNEX

Fourteen specifications were effectively developed in the frame of this Annex. They are presented as separate documents. None of them should be considered as a final product: ideas presented here should be further developed and evaluated. Priority attention is paid to the preparation of the tests and to the use of simulation models (which seems very promising).

The specifications are organized in a hierarchic way, with the consideration to the following constraints:

- Each element of the hierarchy has to be sufficient;
- Each element has to have real connection variables to other elements (i.e.; not just an artificial link);

The following hierarchical levels are considered:

- the whole building;
- the HVAC system(s);
- some subsystems as the air and water distribution networks and air handling units;
- the HVAC component;
- the sensor, actuators and control units.

At each level the specification is presenting a description of the item considered and a presentation of a proposed FTP procedure, including:

- a summary;
- a preparation;
- a test sequence.

This test sequence is including itself:

- some calls to low level procedures,
- some high level evaluation criteria (with consideration to both comfort and energy issues) established on the basis of data available and/or of simulation.

#### 4.5.1 BUILDING

By nature, the building is a very poor calorimeter, which couldn't be used without the help of a comprehensive simulation model (Masy, 2004), (Adam et al, 2004).

An example of very simplified steady state model is presented in Figure 6.

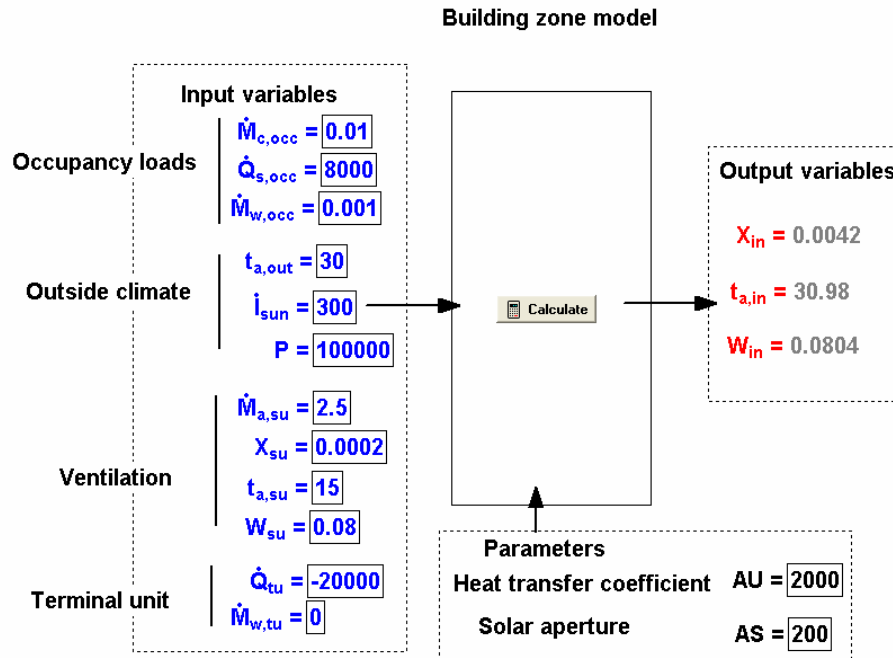

**Figure 6: Steady state model of a building zone**

This model consist in establishing a triple balance on:

- contaminant mass
- energy
- water mass

and is supported by the following equations:

Steady state contaminant mass balance:

$$\dot{M}_{c,occ} + \dot{M}_{a,su} \cdot (X_{su} - X_{ex}) = 0$$

Perfect mixing hypothesis:

$$X_{ex} = X_{in}$$

Steady state sensible heat balance:

$$\dot{Q}_{s,occ} + \dot{Q}_{sun} + \dot{Q}_{fabric} + \dot{Q}_{tu} + \dot{M}_{a,su} \cdot c_{p,a} \cdot (t_{a,su} - t_{a,ex}) = 0$$

$$\dot{Q}_{sun} = AS \cdot \dot{i}_{sun}$$

$$\dot{Q}_{fabric} = AU \cdot (t_{a,out} - t_{a,in})$$

$$c_{p,a} = Cp('AirH2O', T=t_{a,su}, P=P, w=W_{su})$$

Perfect mixing hypothesis:

$$t_{a,ex} = t_{a,in}$$

Steady state water mass balance:

$$\dot{M}_{w,occ} + \dot{M}_{w,tu} + \dot{M}_{a,su} \cdot (W_{su} - W_{ex}) = 0$$

Perfect mixing hypothesis:

$$W_{ex} = W_{in}$$

Even when the building is not directly concerned by the commissioning, its always welcome to verify if the observed ventilation, heating/cooling and (de)humidification demands make sense.

A minimal verification is described in *specification S01: "Building loads"*.

In view of tuning some of parameters the building model and of better defining the building "demands", different experimental procedures are proposed:

- A "co-heating" (or "co-cooling") tests can be used in order to identify the net heating (or cooling) demand in actual operating conditions. This technique is described in *specification S02: "Residential Building Thermal Performance"*
- Pressurization tests performed with a blowing door and air renovation measurements performed with tracer gas can be used in order to identify the building tightness and to validate the calculation of air infiltration. These techniques are described in *specification S03: "Building tightness"*. 3

From other part, in many non-residential buildings, *occupancy loads* are emerging as the most important ones. They would disserve the development of new evaluation methods...

## 4.5.2 THE HVAC SYSTEM

Heating, ventilating and air-conditioning systems must be analyzed as a whole or as separate systems, according to the cases considered. Very different problems may have to be resolved according to the (residential or commercial) building types considered. The information presented here after is not at all exhaustive.

### 4.5.3 AIR DISTRIBUTION NETWORKS

Mostly in non-residential buildings, the *air distribution network* deserves a priority attention.

While relatively passive in nature, this network can often account for a significant portion of the system energy consumption. The few active components in the distribution system can be critical to life safety functions and can impose significant damage on the system, if they function inadvertently and without adequate safety measures, in place to protect the system. Subtle differences, in the way a duct fitting is fabricated, can make significant differences in the pressure losses associated with the fitting.

Are included in this system:

- the air terminal and return units
- the ducting
- the return fans
- the air handling units (with their economizers, filters, coils, humidifiers and supply fans).

An example of very simplified schema of VAV system is presented in Figure 7. In this schema, each number designates a point where the static pressure has to be calculated and/or measured.

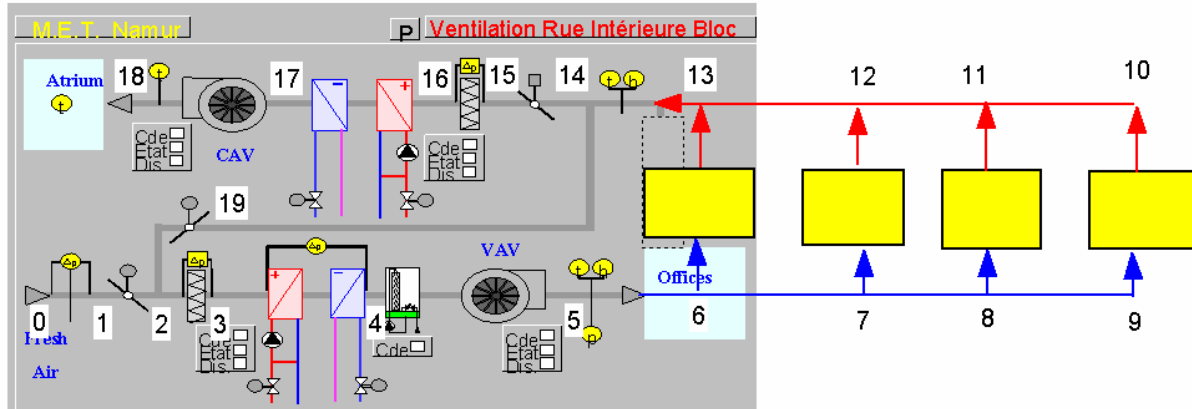

Figure 7: Simplified schema of a VAV system

Pressures and flow rates are related through the following equations:

**Fresh air measurement:**

$$\Delta p_{0,1} = p_0 - p_1$$

$$\Delta p_{0,1} = R_{0,1} \cdot \dot{M}_{0,1}^n$$

**Fresh air damper:**

$$\Delta p_{1,2} = p_1 - p_2$$

$$\Delta p_{1,2} = R_{1,2} \cdot \dot{M}_{1,2}^n$$

$$\dot{M}_{1,2} = \dot{M}_{0,1}$$

**Filter:**

$$\Delta p_{2,3} = p_2 - p_3$$

$$\Delta p_{2,3} = R_{2,3} \cdot \dot{M}_{2,3}^n$$

etc.

An analysis method is proposed in *specification S04: "Air conditioning system"*, which is supported by some components testing specifications presented hereafter.

In this case the item "evaluation of expected performances" includes actual evaluations of:

- measuring and control points;
- actuators performance (e.g. authority);
- fan performances measurement method;
- preliminary calculation of pressure losses and balancing;
- number of zones to be selected and tested.

In this case also, the item "preparation of instrumentation" concerns:

- the air handling units;
- the selected zones;
- the distribution network.

A simulation model is proposed as a help for experimental design and instrumentation of measuring results.

Another specification is dealing with (smaller) residential ventilations networks (see 4.6).



#### 4.5.4 WATER DISTRIBUTION NETWORKS

A non-sufficient performance discovered at the level of the air distribution system may justify to go further “upstream”, towards the hot and cold water distribution systems (Vaezi-Nejad, 2001).

Water distribution can be submitted to FPT’s very similar to those applied to air distribution. An important difference is that the fluid flow measurement cannot be as “intrusive” as in air. Another difference is that more reliable measuring techniques are available for liquid than for gas: ultrasonic flow rate measurements, calibrated turbines, control valves, balancing valves and fixed orifices.

Pressure measurements are also usually easier and more accurate.

“Parasitic” heat exchanges are very often negligible. And, of course, tightness is no more an uncertainty (the water network has to be tight!).

#### 4.5.5 AIR HANDLING UNITS

These subsystems can also be submitted to some global evaluation (Vaezi-Nejad, 2004) or analyzed in more details by distinguishing the following components:

##### ***Fans***

*The fan* is the heart of the air handling system, since it is one of the most significant energy users in a building.

Commissioning and re-commissioning fans and drives is a key factor for ensuring that a building’s efficiency goals are met over the life of the building.

There are both indirect and direct components to fan energy consumption. The indirect component relates to the system the fan serves. The direct fan energy component relates to how efficiently the fan can convert the energy going into its prime mover (usually electricity into a motor) into air flow and pressure in the fan system.

The fan energy consumption is a function of several fundamental components: flow rate, static pressure, fan efficiency, and motor efficiency. Commissioning efforts are targeted at these factors, to ensure system efficiency, performance, and reliability.

A typical problem, found during commissioning or retro-commissioning, is high static pressure in the fan system. In creating excess static pressure, that is not required to operate the system, a fan wastes significant amounts of energy. It’s also important to check that the fan is working in a stable zone (crucial problem with axial fans).

But a fan can also be used as an airflow-measuring device. According to the fan type, it’s possible to use two couple of measured variables, associated to the fan model (Erikson, 2004) (cf § 6.1):

- 1) The rotation speed and the supply-exhaust pressure difference;
- 2) The rotation speed and the electrical power.

This technique is described in *specification S05: "Fans"*.

It seems particularly helpful when direct measurement of air velocities is not reliable, as in the example presented in Figure 8.

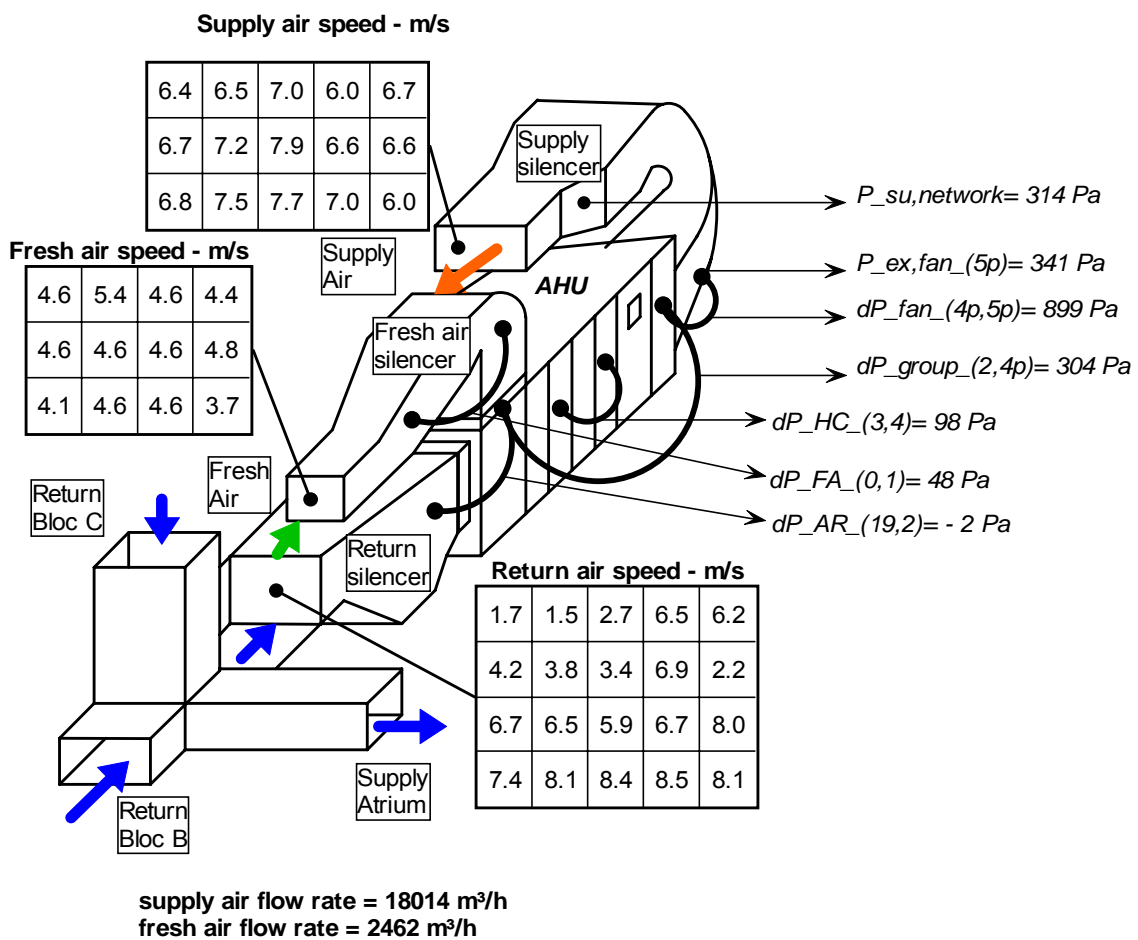

**Figure 8: Example of air velocity measurements performed inside air ducts**

### Dampers

The economizer also deserves special attention.

Its commissioning can play a key role by:

- Functional performance testing and coordinating with the balancing at start-up, to ensure proper minimum outdoor air flow rates and building pressure relationships;
- Training the operating staff, to help them understanding the initial settings and to ensure their persistence;
- Document the initial settings, as well as the procedure used to obtain them, thereby further ensuring their persistence.

## Heating and cooling coils

These components are usually well defined, but their locations inside air handling units don't facilitate the tests (Cuevas et al, 2002a), (Cuevas et al, 2002b):

- Temperature averages are not easy to define on air side;
- The water flow rate is not always measurable.

## Humidifiers

At first look, they may appear as very simple and robust devices, but they deserve also some attention:

- With liquid water humidifiers, it's important to verify, not only the contact effectiveness, but also the global efficiency (in terms of water consumption);
- With steam humidifier, the risk of condensation on internal duct surfaces has also to be verified.

The procedure to be applied in the first case is described in *Specification S06 "Humidifiers"*.

## Heat recovery

Good functioning of heat recovery is essential for good energy performance of a building in cold climate. There exist numerous types of heat recovery devices. To each of them corresponds one particular control mode and also a risk of specific fault:

- The effectiveness of a rotary heat exchanger is controlled by tuning the rotation speed and this control might be faulty (Bauman and Kobe, 2004a and Kronhoffer, 2003);
- A flat plate heat exchanger is usually equipped with a by-pass system, which may be the cause of a unsatisfactory effectiveness;
- In a coil-and-brine-loop heat recovery system, it's the brine flow rate which must be controlled and this control also might be faulty (Eriksson 2004).

## Control of the AHU

Specific methods are also developed for commissioning of control logics of AHU (André et al, 2002b). Verification of supply temperature is illustrated in Figure 9.

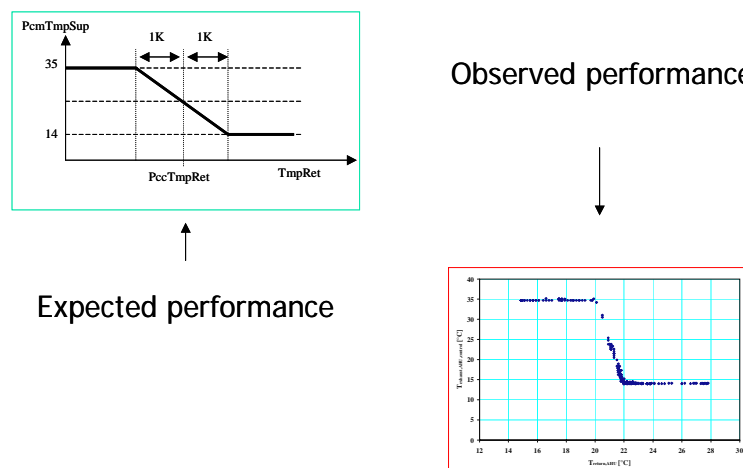

Figure 9: Verification of supply temperature

The Dutch group developed a tool for checking the set points (heating/cooling curve) of the supply air of AHU's. The tool will generate a building-specific heating/cooling curve based on an energetic optimum between the demand for heating and cooling in the zone's. The input data used to generate the function cover the characteristics of the building, the organisation, and the HVAC equipment.

The method described in (Elkhuizen et al., 2002; Elkhuizen et al., 2004) shows the serious need of an optimal tuning of heating/ cooling curves in HVAC systems and how to use heat recovery systems and recirculation of the exhaust air in the right way and how they should be controlled and taken into account.

The optimal heating/ cooling curve is determined by building physics and building loads.

Important change in building use or internal heating load required re-tuning of the heating/ cooling curve. The energy saving potential of optimal heating curves is 5 – 35 % in relation with common heating curves.

In real practise, the effect of retuning of the heating/ cooling curve of the central AHU on energy savings is (Elkhuizen et al., 2004) for heating between 10 – 25 % and for cooling between 10 – 35 %.

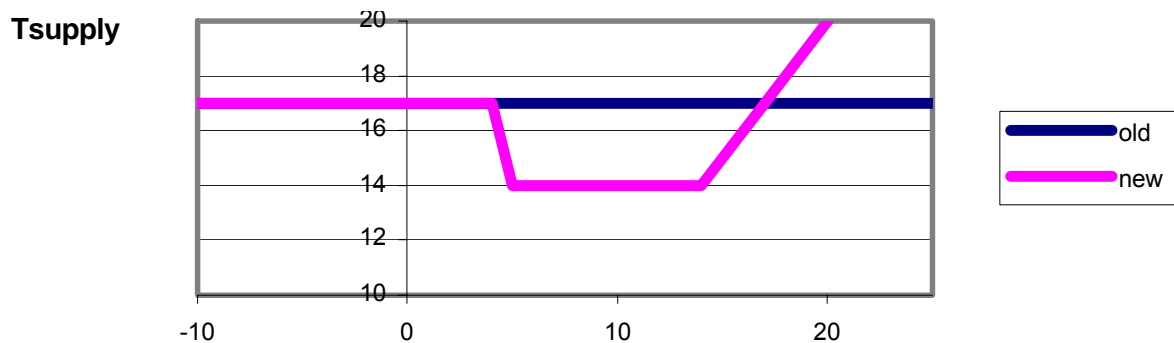

Figure 10: Retuning of heating curve

## Heating and cooling plants

A malfunctioning found at the level of the water distribution (for example a lack of heating or cooling power, or a non-respect of distribution temperature set-point) may justify to “go back” until the heating/cooling plant.

In first analysis, the plant can be simulated and tested as a whole. An example of such global modeling is shown in Figure 11.

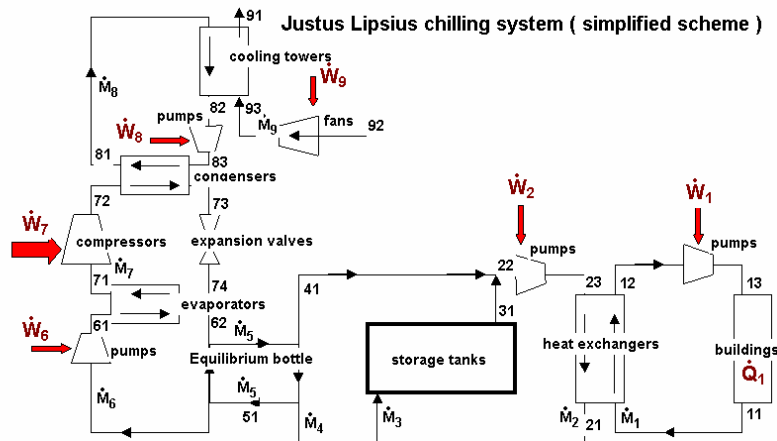

Figure 11: Simplified schema of a cooling plant

This model counts with 9 fluid “loops”, connecting the chilled water distribution to the outside environment; they are:

- 1) The chilled water distribution, connecting the plant to the building;
- 2) The brine loop connecting the ice storage system to the heat exchangers;
- 3) The return of this same loop;
- 4) The brine loop, connecting the equilibrium bottle to the ice storage system;
- 5) The brine circulation inside the equilibrium bottle;
- 6) The brine loop, connecting the chillers evaporators to the equilibrium bottle;
- 7) The chillers refrigerant circuits;
- 8) The warm water loop, connecting the chillers condensers to the cooling towers;
- 9) The circulation of outside air through the cooling towers.

The same mode of decomposition into elementary loops can be applied to different heating and cooling plants.

“Zooms” can then be performed on some of the components included in the plant, according to the problems encountered. If correctly modelled, some of these components can be used as heat flow meters.

For example:

- 1) The useful heating power provided by a boiler can be determined from its fuel consumption;
- 2) The useful cooling power provided by a chiller can be determined from the electrical consumption of its compressor, associated to evaporation and condenser pressures, which are usually indicated on the control panel. The compressor is then used to “measure” the refrigerant flow rate and the evaporator balance gives the corresponding cooling power.

One of the most sensitive components of the plant is the cooling tower. Its performances can be deeply affected by non-adapted water flow rate and by fouling.

This has justified the setting-up of a *specification S07: “Cooling towers”*.

### **Terminal units**

The terminal equipment associated with an HVAC system provides the interface between the HVAC process and the building occupants. For the HVAC system to be perceived as successful by the end users, the terminal equipment must reliably perform its intended function, otherwise the system will not fulfil its design intent, regardless of the level of performance at the central system (Cuevas et al, 2002). If the terminal units are poorly commissioned, or improperly adjusted, in relation to the actual loads they are serving, significant amounts energy can be wasted.

Intrinsic performances of terminal units should be already well known before integrating them inside the whole HVAC system (laboratory tests are much easier than on-site verification). But the experience shows that various mistakes are currently committed when installing them. Typical examples are:

- Wrong design and installation of a fan coil envelope;
- Wrong connection and/or adjustment of the control system of a VAV box.

Such typical mistakes have justified the development of *Specification S08: “Terminal Units”*.

An example of simplified representation of a terminal unit is given in Figure 12.

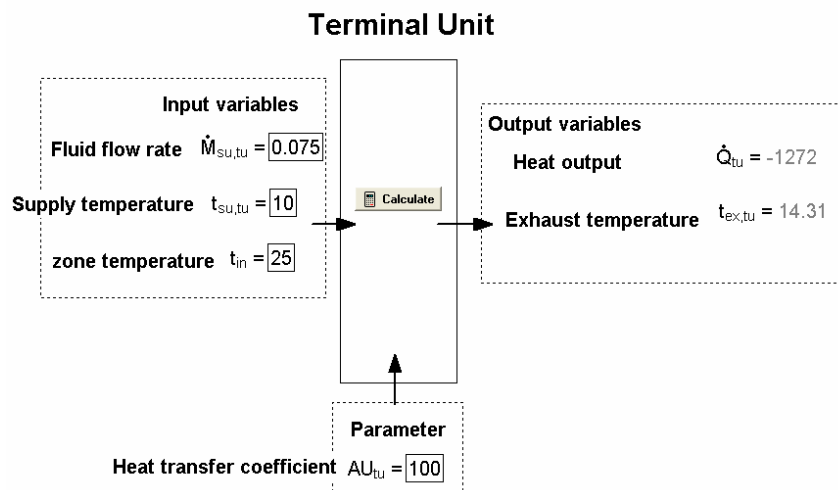

**Figure 12: Information flow diagram of a terminal unit**

This representation can be supported by the following equations:

$$\dot{Q}_{tu} = \varepsilon_{tu} \cdot \dot{C}_{tu} \cdot (t_{su,tu} - t_{in})$$

$$\varepsilon_{tu} = 1 - \exp(-NTU_{tu})$$

$$NTU_{tu} = \frac{AU_{tu}}{\dot{C}_{tu}}$$

$$\dot{C}_{tu} = \dot{M}_{su,tu} \cdot c_{tu}$$

$$t_{ex,tu} = t_{su,tu} - \frac{\dot{Q}_{tu}}{\dot{C}_{tu}}$$

#### 4.5.6 SENSORS, ACTUATORS AND CONTROL

Priority specifications are proposed for the BEMS with its actuators, sensors, connections, control and management units and softwares.

For this subsystem, the FPT consists in:

- Checking the sensors and *re-calibrating* then (if required);
- Checking the correct working of the actuators (a visual inspection is mandatory);
- Identifying the signal conversion and tuning them (if required);
- Identifying the control laws imbedded in the system (with all parameters concerned).

The functionality in the BEMS software and signalling from the sensors/components to the BEMS is important (Liu and Claridge, 2001).

These crucial tasks are described in § 5.

A series of FPT specifications (Aparecida Silva et al, 2004) is also proposed for the sensors dealing with:

- temperatures;
- heat flow;
- humidity;
- pressure;
- speed and fluid flow rate;
- electrical current, voltage, power and energy;
- rotation speed and vibration;
- air quality and CO2 concentration.

#### 4.5.7 THE BEMS

The BEMS must be submitted to careful tests.

For this subsystem, the FPT consists in:

- Checking the sensors and *re-calibrating* them (if required);
- Checking the correct working of the actuators (a visual inspection is mandatory);
- Identifying the signal conversion and tuning them (if required);
- Identifying the control laws imbedded in the system (with all parameters concerned).

The functionality in the BEMS software and signalling from the sensors/components to the BEMS is important (Liu and Claridge, 2001).

These crucial tasks are described in chapter 5.

The following specifications were also developed:

*S09: "Sensors of HVAC Systems"*

*S10: "Temperature sensors"*

*S11: "Humidity sensors"*

*S12: "Pressure sensors"*

*S13: "Flow sensors"*

*S14: "Air quality sensors"*

#### 4.5.8 FOCUS ON ONE EXAMPLE OF SPECIFICATION: S04 "AIR CONDITIONING SYSTEM"

##### ***Description of the considered object***

The objective of the aeraulic system in a building is to control, in each occupied space, a part or the whole of the following variables:

- air quality,
- environmental temperature,
- air humidity content.



## Operating principles

A typical VAV system includes the following subsystem and components (Figure 13):

- Air Intakes
- Air Handling Units including
  - economizer
  - filters
  - coils
  - humidifiers
  - supply and return fans
- Air distribution network
- Terminal units (VAV boxes)
- Control system with sensors, actuators and controllers.

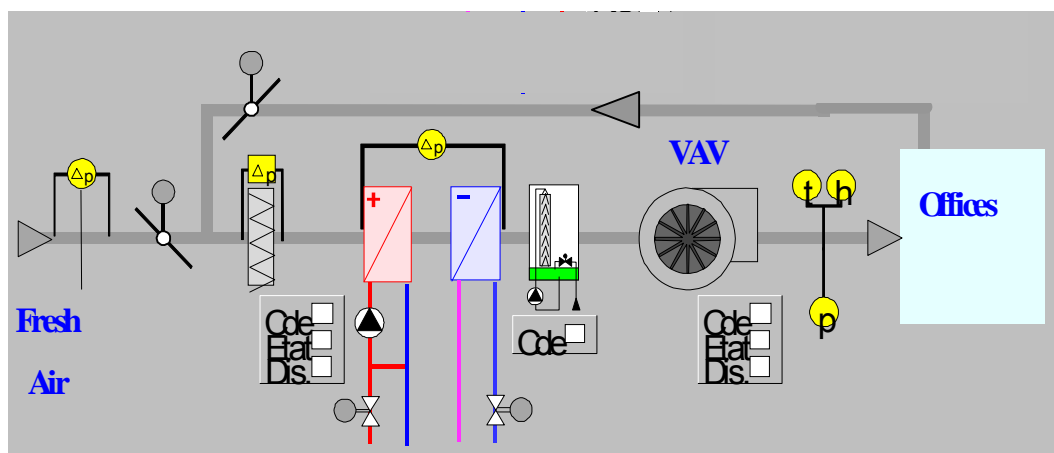

**Figure 13: General view of a typical air distribution system**

The energy saving potentials are related to the following characteristics:

- air network configuration
- network tightness
- building insulation
- pressure drops
- fans characteristics
- control strategies
- coils characteristics
- heat recovery characteristics

## Data provided by the manufacturers

Data provided by the manufacturer normally concerns the whole set of components and are provided as component data-sheets.

All designer, manufacturer and installer data should be included in the as-built records, including:

- The Owner's Project Requirements (OPR) established by the owner with the help of the commissioning authority including:
  - The owner program (OP);
  - The Design Requirements (DR).
- The design documents including:
  - The construction specification;
  - The guide for system control and operation;
  - The calculations (with corresponding hypotheses, methods and results).
- The testing, tuning and balancing results for air distribution network and control.
- The previous commissioning results (if any).
- Other technical documents, as:
  - The list of the components actually installed;
  - Installation plans;
  - The technical documentation of each component.

## Problems to be considered

- Some problems are met at installation phase:

The commissioning method has to allow to detect and to correct these mistakes early enough, i.e. when all components concerned are still easy of access. This is particularly true for problems of:

- (electrical, pneumatical and mechanical) connections;
- balancing;
- tightness;
- set point tunings;
- sensors conversion laws;
- control parameters;
- component location (VAV boxes, sensors, ...);
- calibration of measuring devices;
- noise;
- interferences;
- control programming;
- data storage.

- Some other problems are likely to occur in the *working phase* and should be detected thanks to *continuous commissioning*.

Most typical *aging* problems are :

- corrosion;
- sensors drifts;
- dirtiness of filters, coils, humidifiers and registers;
- broken belt.

In the present document, focus is given to the verification of a few characteristics: air-tightness, pressure drops, fans characteristics and control strategies.

### ***Description of the testing procedure***

#### **OBJECTIVE OF THE TEST**

The goal of this test is to verify if the installation is realized according to the specifications given in the 'design documents'.

#### **PREREQUISITE**

Before starting the test, it has to be verified that:

- the design documents are available;
- the measurements made by the BEMS are available;
- the AHU, the distribution system and the VAV terminals are connected among themselves and are fully operational;
- the offices are at "neutral" temperature, i.e. at the middle of the control range of the VAV terminal units (usually around 22 or 23°C);
- the primary equipment is correctly working;
- the installation status is the most appropriate for the test considered (for example, a tightness test should be preferably performed when the network is totally accessible, i.e. during the elaboration phase, before insulating the ducts...)

## REQUIRED MATERIAL

- The BEMS for storing of the followed up points and the installation control
- 1 portable pressure sensor\*
- 1 combined temperature/humidity sensor\*
- 1 portable air speed sensor\*
- 1 portable CO2 sensor \*
- 1 wattmeter
- 1 tachymeter
- 1 sound meter

(\* with possibility of time integration).

## PREPARATION PHASE

### Evaluation of the available information:

The following information should be checked before starting the testing phase:

- Identification of available measurement points: the available sensors should be identified and checked according to a rigorous procedure [6 ].
- Identification of actuators characteristics.
- Identification of control strategies already implemented in the BEMS.

### Additional information to be used:

Given the complexity of the system considered, any additional information, in terms of modelling results or special measurement techniques, can be useful.

This part of an HVAC system is traditionally the object of an important calculation which is performed:

- At design stage (to have a first sizing of the components)
- At installation stage (to have a final sizing of the components)

This information can be used as reference.

An a posteriori calculation can be performed on the basis of all information available.

### Special measurements:

Performances of individual components can be verified with the help of specific procedures.

After having been commissioned, these components can be used as additional measuring devices, eg:

- the pressure drop across the coils (heating+ cooling) can be used to determine the air flow rate supplied by the AHU;
- the pressure rise across the fan, associated to its rotation speed, can also be used to determine the corresponding air flow rate.

## **Additional instrumentation to be installed:**

### **Instrumentation of AHU's:**

If not already available, the following measuring points should be added in the AHU:

- Supply and exhaust static pressures
- Fan rotation speed and supply-exhaust static pressure difference
- Supply and exhaust air temperatures

### **Instrumentation of test offices:**

A minimal instrumentation consists into a set of probes measuring the environmental temperatures in some selected offices.

A tracer gas equipment can also be used to check the air renewals in the rooms.

### **Instrumentation of the ducts:**

The verification of the air distribution performances will be much easier if a set sensors and connecting accessories are available for measuring the static pressures in all the main “branches” of the network.

## **EXECUTION PHASE**

### **Summary of the test method:**

The method consists in testing the performance of a certain number of components and sub-systems of a ventilation system.

The originality of the method is to combine different functional performance tests, elaborated individually per component and sub-systems, in such a way to make the most efficient use of all experimental conditions encountered:

Dealing with each component separately would generate a important waste of time: almost the same experimental conditions would have to be reproduced several times.

Test method:

**1<sup>st</sup> step : test in manual operation**

Objectives
<ul style="list-style-type: none"> <li>▪ <b>Verification of the actuators in ON/OFF and modulation commands</b></li> </ul>
Actions
<p style="color: red;"><b>The plant should operate in “manual” mode (i.e. no longer under control of the BEMS), in order to generate the required conditions. Therefore, the following actions have to be performed through the BEMS:</b></p> <ul style="list-style-type: none"> <li>Open “manually” all dampers and valves</li> <li>Set the maximal fans rotation speeds</li> <li>Set “ON” the pumps and fans commands</li> </ul>
<ul style="list-style-type: none"> <li>▪ <b>Verification of the commands and modulations of the control devices</b>            Compare the real state of the components to the controls and modulations imposed by the BEMS: valves, dampers, pumps and fans.            From the BEMS, put each fan at its minimal rotation speed and, in situ, verify its real state.</li> </ul>

**2<sup>nd</sup> step : test in manual stop**

Objectives
<ul style="list-style-type: none"> <li>▪ <b>Verification of the commands and modulation of the control devices</b></li> <li>▪ <b>Verification of the sensors</b></li> <li>▪ <b>Verification of the BEMS archiving capabilities</b></li> </ul>
Actions
<p style="color: red;"><b>In order to put the installation in “manual” stop, the following actions have to be performed through the BEMS:</b></p> <ul style="list-style-type: none"> <li>“Manual” closing of all dampers and valves (modulation to 0%)</li> <li>“Manual” turning off of the pumps and fans (command "OFF")</li> </ul>
<ul style="list-style-type: none"> <li>▪ <b>Verification of the commands and modulations of the control devices:</b>            Compare the real state of these components with the commands and modulations given by the BEMS</li> <li>▪ <b>Verification of the sensors</b> <ul style="list-style-type: none"> <li><b>Duct temperature and humidity sensors :</b>                Check temperature and humidity sensors by the “manual checking” method [6]</li> <li><b>Room temperature sensor :</b>                Check room temperature sensors by the “physical redundancy” or “diagnosis test” method [6]</li> </ul> </li> <li>▪ <b>verification of the offsets of pressure sensors:</b>            Check pressure sensors by the “diagnosis test” method [6]</li> <li>▪ <b>Control of the data storage (BEMS)</b>            Check the data storage function of the BEMS by the “sensors measurement observation” method [6]</li> </ul>

### 3<sup>rd</sup> step : test in “normal” operation

Objectives
<ul style="list-style-type: none"><li>▪ Verification of fan performances</li></ul>
Actions
<p style="text-align: center;"><b>Put the fan in normal operation</b></p> <p>From BEMS : Put the valves, dampers, pumps and fans in automatic mode.</p>
<b>Verification of fan performances by the method described in [7]</b>

### 4<sup>th</sup> step : test in maximum air flow rate (summer condition )

Objectives
<ul style="list-style-type: none"><li>▪ Verification of the controls set point</li><li>▪ Verification of the air flow rates at the level of the AHU ( fresh air, re-circulated air and addition of both) and at the level of a reference office</li><li>▪ Verification of pressure drops and air leakages in the air distribution network</li><li>▪ Verification of the authority of the control devices (valves and registers)</li><li>▪ Verification of the tightness of the network</li></ul>
Actions
<p style="text-align: center;"><b>Put the ventilation in maximum flow</b></p> <ul style="list-style-type: none"><li>▪ Verify that the office is at “neutral” temperature ( ideally the point in the middle of the control range of the VAV boxes)</li><li>▪ Put the thermostats of the VAV boxes at their lowest set points (in order to “call” for a maximum of cooling power)</li><li>▪ Wait for a stabilization of the regime</li></ul>
<p>Measure static pressures at different points of the network; compare with installer aeraulic calculations and with other modeling results, if available</p> <p>Measure fan flow rate by the method given in [7]</p> <p>Optionally, measure air renewal rates in selected offices by tracer gas technique.</p>

### 5<sup>th</sup> step : test in minimum air flow rate (winter condition)

Objectives
<ul style="list-style-type: none"><li>▪ <b>Verification of the performance of the fresh air flow control in minimum regime</b></li><li>▪ <b>Verification of the minimum fresh air supplied in the reference office</b></li></ul>
Actions
<p style="text-align: center;"><b>Put the ventilation in minimum flow</b></p> <ul style="list-style-type: none"><li>▪ Put the thermostats of the VAV boxes at their highest set points (in order to “call” for a minimum of cooling power)</li><li>▪ Wait for a stabilization of the regime</li></ul>
<ul style="list-style-type: none"><li>▪ Same measurements and comparisons as in the previous (4<sup>th</sup>) step...</li></ul>

### 6<sup>th</sup> step : test in automatic stop

Objectives
<ul style="list-style-type: none"><li>▪ <b>Verification of the system state in automatic stop</b></li></ul>
Actions
<p>The plant should operate in “stop” mode, in order to generate the required conditions. Therefore, the following actions have to be performed through the BEMS:</p> <p>Put the ventilation in automatic stop from the management program of the BEMS</p>
<ul style="list-style-type: none"><li>▪ <b>Verification of the system state in automatic stop:</b> Are all valves, dampers, pumps and fans closed?</li></ul>

### ***Among Additional possibilities***

#### **Use of models for the calculation of pressure drops in the aeraulic network:**

Installers usually use simple programs to compute pressure drops in the air distribution network: duct lengths and specific devices (bends, silencers, dampers, connections...) are characterized by default values and the network is calculated for an a priori selected “worst” case, for which the pressure drops are considered to be the highest. The calculation is done for a given air velocity, assuming that the fan is able to generate this velocity.

More advanced methods iteratively calculate the pressure distribution by solving the non-linear system of equations, corresponding to the typical situation.



## 4.6 RESIDENTIAL BUILDINGS

### 4.6.1 THERMAL PROPERTIES OF BUILDING ELEMENTS AND WHOLE HOUSE

Thermal performance of whole house is the one of major factors that make thermal comfort and energy consumption for temperature control of the room space. The thermal performance of the house is affected by the thermal properties of the insulation material, heat flow through the heat bridge, real settings of insulations and long term durability of the insulation resistance. Thus we should consider it varies from the original intent before construction. It is better to verify the real thermal performance at suitable timing.

In order to verify it, there are two FPT ways. The one is the calculation from measuring results of thermal resistance of each wall parts. The other is the measuring for whole house directly. Iwamae et al. (2004) have reported the measurement method for detached residential buildings.

Measuring thermal resistance of wall is done by as follows.

1. Monitor the air temperature of the both side of the wall
2. Measure the heat flux flow through the wall
3. The thermal resistance is given by temperature difference divided by heat flux

Measuring thermal performance of the whole house is as follows.

1. Monitor the temperature difference between indoor and outdoor
2. Measure the heating or cooling energy in the indoor space
3. The thermal performance of the whole house is given by the temperature difference divided by heating/cooling load

In both ways, there are several factors which cause the measuring error as follows.

1. Solar heat
2. Large heat capacity of the wall
3. Temperature distribution in the space
4. Rapidly change of variation of the outdoor temperature

If it has been affected by these factors during FPT, it is better to discard the measuring results.

### 4.6.2 VENTILATION SYSTEM FOR RESIDENTIAL BUILDING

Mechanical ventilation systems installed in residential buildings have typical feature. Those systems accept natural ventilation called stack effect or infiltration. Natural ventilation has both positive and negative effect to the performance of mechanical system. Functional performance testing of ventilation system installed in a residential building must consider this side effect. There are also natural ventilation systems that do not use mechanical equipments for ventilation.

Thus, functional performance testing of ventilation system installed in residential buildings must evaluate the unit performance and the overall system performance including building performances. In some cases, the unit performance can be measured by utilizing the component as “measuring device”. In other cases, the unit performance, mainly evaluated by mechanical airflow volume, may be measured by airflow meter. The overall system performance can be measured using gas douser and sampling devices. Functional performance testing process is commonly connected with performance recovering process. A performance recovering process of a ventilation system for residential building is shown in the CD Rom (Ohta et al. 2004).

#### **4.6.3 HEATING/COOLING SYSTEMS FOR RESIDENTIAL BUILDING**

Heating/Cooling systems in residential & simple buildings, which “Functional Performance testing” need to be applied to, include room air conditioner and radiative panel / floor heating. Improper design and construction / installation of these systems increases energy consumption. Therefore commissioning of the system by “Functional Performance testing” is important.

As a criterion of the system performance of floor heating system (Miura et al. 2004), for example, following parameters are evaluated: controllability of the floor surface temperature, characteristics of the transient heat supply, energy consumption. Since the performance depends strongly on the design and construction of the system, control method and usage, it is important to design and install the floor heating system properly in accordance with the owner’s requirement. Therefore, the performance of the system needs to be checked by using “Functional Performance Testing”. Moreover, the users could be advised to use the system properly through “Functional Performance Testing”, so that improper usage (e.g. improper set point temperature of the floor heating, improper setting of the furniture on the floor).

Regarding cooling, the performance of air conditioner (including multi system and packaged air conditioner for simple building) is given by COP and seasonal COP (SCOP). The COP value measured by the experimental technique defined by ISO 5151 is obtained under specified conditions. On the other hand, energy consumption in real situation largely depends on outdoor conditions, set point temperature, location of the external unit and so on. Therefore, the (Rated) COP value and the performance in real situation could be different. “Functional Performance Testing” helps to judge whether the system was designed and installed properly and to check the real performance of the system. Moreover, “Functional Performance Testing” is used as a tool for checking the performance degradation caused by the decrease in the heat exchange rate, by gas leakage and etc. (Miura et al. 2004).

#### **4.6.4 FPT TOOLS FOR RESIDENTIAL BUILDINGS**

There are several types of the performance of the residential building for achieving energy conservation: annual air conditioning load, a ventilation performance, etc. The performance of the heating/cooling equipment and ventilation equipment installed in a residential building has also influence on energy consumption. On these performances, commissioning is performed using various tools.

There are two types of Commissioning tools for residence and equipment: Field measurement tools and Simulation tools. Field measurement tools are the tools for the residential houses after acceptance and equipment installed in an occupancy & operation phase using measuring instruments, such as a thermometer and an airflow-meter. One sample of field measurement is shown in Figure 14. This is the air-tightness testing of whole house. Simulation tools are the tools that perform commissioning by the numerical computation, and verified based on a plan document in a design phase.

There are several types of FPT procedure for commissioning the residential house, and each country has its own tools (Sandberg et al. 2001). Commissioning tools widely applied in Japan are explained in the CD Rom (Umeno, 2004).

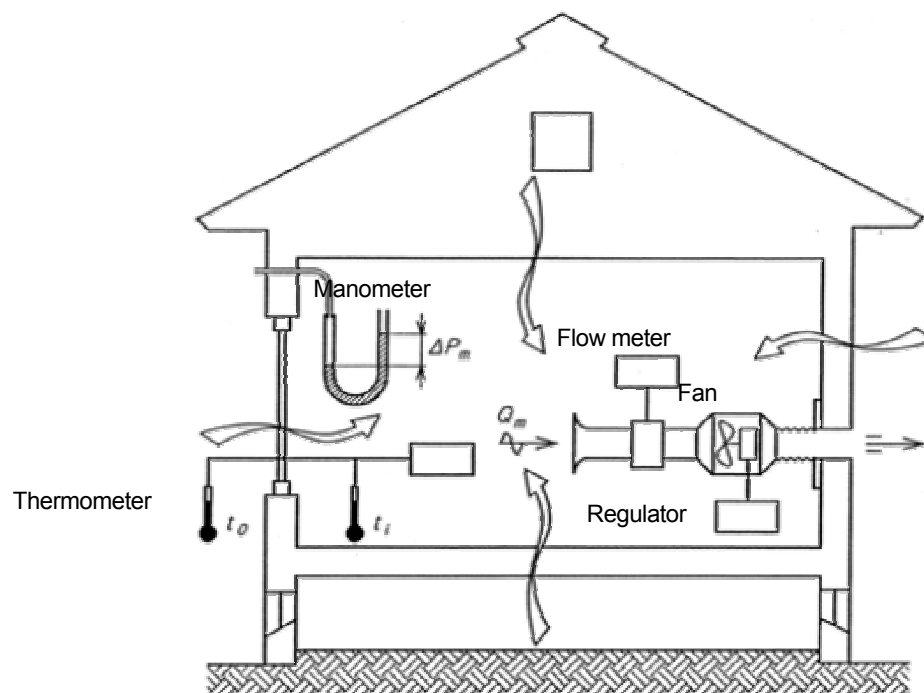

**Figure 14: Air-tightness measurement of residential building**

#### 4.7 OTHER FPT SOURCES AND REFERENCES

Adam, Ch., André, Ph., Aparecida Silva, Cl., Hannay, J., Lebrun, J., 2004. "Commissioning-orientated building loads calculations. Application to the CA-MET building in Namur (Belgium). Proceedings International Conference for enhanced building operations (ICEBO'04), Paris.

André Ph., Lacôte, P., Adam Ch., Collard L., Cuevas, Ch., Delarge, O., Georges, B., Lebrun J., «Use of simulation in the commissioning of an office building», 2002a.

Proceedings, SSB'Congress, Liège, 2002.

André Ph., Lacôte P., Adam Ch., Collard L., «BEMS commissioning in the CA-MET building: AHU control » A40-C1-B-M4-FUL-01, 2002b.

André Ph., Cuevas, Ch., Lacôte P. and Lebrun, J., "Re-commissioning of the CA-MET HVAC system: a successful case study?" Proceedings International Conference for enhanced building operations (ICEBO'03), Berkeley, 2003.

André Ph., Aparecida Silva C., Fonseca N., Hannay J., Lacôte P., and Lebrun, J., "Example of Functional Performance Test. FTP for VAV ventilation system." A40-B2-B-M7-ULg-01, 2004a.

André Ph., Aparecida Silva C., Fonseca N., Hannay J., Lacôte, P., and Lebrun J., "Re-commissioning of the VAV air distribution system of the CA-MET building in Namur (Belgium)." A40-B2-B-M7-ULg-01, 2004b.

André Ph., Lacôte P., Aparecida Silva C., Hannay J. and Lebrun, J., «A Functional Test Procedure for the improved commissioning of a VAV system" Proceedings International Conference for enhanced building operations , ICEBO'04, Paris, 2004c.

André Ph., Aparecida Silva C., Fonseca N., Hannay J., Lacôte, P. and Lebrun, J., " Re-commissioning of a VAV air distribution system." Proceedings International Conference for enhanced building operations, ICEBO, Paris, 2004d.

Aparecida Silva C., Hannay J., Lebrun J., Adam Ch, André Ph. and Lacôte, P., "FPT: sensors of HVAC systems. A40-B2-M8-B-ULg-01, 2004.

Baumann O. and Kibe H. Functional Performance Test of a Rotary Heat Exchanger using Models. A40-B2-M8-D-EBERT-01, 2004a.

Baumann O. and Kibe H., Functional Performance Test of a Heat Pump System using Models. A40-B2-M8-D-EBERT-02, 2004b

Cuevas Ch. and Lebrun J., "Re-commissioning of a cooling plant." A40-B2-B-M4-ULg-02, 2002.

Cuevas, Ch., Lebrun, J., Lacôte, P., André, Ph., 2002a « Re-commissioning of an Air handling Unit." Proceedings ABT'2002 Congress, Hong-Kong.

Cuevas, Ch., Lacôte, P., Lebrun, J., 2002b "Re-commissioning of an Air Handling Unit." A40-B2-B-M4-ULg-01

Cuevas Ch., Lebrun J., Lacôte P. and André Ph., «Re-commissioning of VAV boxes.» A40-B2-B-M4-ULg-03, 2002c.

Elkhuizen P.A. and Peitsman H.C., "A new design guideline for the heating and cooling curve in AHU of HVAC systems", "A method for the optimal adjustment of AHU in HVAC systems", A40-E-M4-NL-TNO-1, 2002.

Elkhuizen, P.A., Scholten J.E., Peitsman H.C. and Kooijman A., "The effect of optimal tuning of the Heating-/ cooling curve in AHU of HVAC system in real practise, Proceedings, ICEBO, Paris, 2004.

Elkhuizen P.A., Peitsman H.C. and Wienk W.J., "A new design guideline for the heating and cooling curve in AHU of HVAC systems", Building Services Engineering Research and Technology, Volume 24, number 3, pages 191-202, 2003.

Erikson J., Fan Model Description. A40-D1-M8-SWE-SP-01, 2004.

Haasl T., Sellers D. and Friedmann H., "A new guide for commissioning Air Handling Systems: using a model functional test", A40-B2-M3-USA-LBNL-01, 2002.

Haasl T., Sellars D. and Friedman H., "Use of commissioning function test guide." A40-B2-M5-US-LBNL-01, 2003.

Iwamae, "A measurement method of actual thermal performance of detached house." A40-B1-M7-J-KinkiU-1, 2004.

Kronhoffer, "Experiment with active functional test on a laboratory AHU." A40-D1-M6-SWE-KTH, 2003.

Laruelle C., Morisot O., and Marchio, D., "Operator outlook on commissioning of existing buildings in France.", A40-B2-M3-F-ELYO-01, 2001.

Lebrun J. and Aparecida Silva C., "Cooling tower – model and experimental validation". ASHRAE Symposium, Atlantic City, 2002.

Lebrun J., Humidifier Model Description. A40-D1-M8-B-ULg-01, 2004.

Liu M., Claridge D., "Tools and equipment for continuous commissioning". A40-B2-M1-US-TAMU-01, 2001.

Masy, G. "Modelling of residential building and heating systems." Proceedings, ICEBO, Paris, 2004.

Miura, "Manual commissioning for floor heating system in O-House." A40-B1-M5-J-KyotoU-1, 2003.

Miura, "In-situ measurement of real performance of room air-conditioner" A40-B1-M7-J-KyotoU-1, 2004.

Ohta, "Commissioning tools for mechanical ventilation system." A40-B1-M6-J-Misa-1, 2003.

Sandberg M. and Eriksson J., "Commissioning of residential buildings in Sweden". A40-B1- M2-S-SP-01, 2001.

Umeno T, "Various tools for FPT procedures" A40-B1-M7-J-Sekisui-1, 2004.

Vaezi-Nejad, H., "Commissioning process for hydraulic heating systems in France." A40-B2-M2-F-CSTB-01, 2001.

Vaezi-Nejad H., "Retro-commissioning the Aria building using Cite-AHU: an Annex 40 collaboration.", Proceedings, ICEBO, Paris, 2004.

Wang S., "Health monitoring and continuous commissioning of centrifugal chiller plant." Proceedings, ICEBO, Paris, 2004.

## 5. USING THE BUILDING CONTROL SYSTEM FOR COMMISSIONING

### 5.1 INTRODUCTION

Today, microprocessor-based control systems are used to automatically operate many of the major energy systems in buildings. As technology continues to evolve, the trend is for more systems to come under the action of automatic control and for disparate systems to be integrated across communication networks. Automatic control systems eliminate the need for dedicated manual operators and can reduce costs. Modern control systems also allow the operation of multiple energy systems to be coordinated according to advanced building-level strategies. The proliferation of automation in buildings has led to a situation in which realizable building performance is fundamentally dependent on the control system. An important part of commissioning should therefore be to ensure that the control system is operating properly.

It is useful at this point to define what components we assume constitute the building control system. Firstly, we assume that the control system encompasses both hardware and software. On the hardware side, we limit the scope of our definition to the following components: sensors, actuators, wiring, switches, and (microprocessor-based) control devices. The boundary for the hardware side is therefore the point of interface to the energy systems and the controlled environment. We limit our scope on the software side to the control algorithms, user interface, and other miscellaneous functionality that is typically packaged in modern systems.

Control systems are becoming more modular and, from a commissioning perspective, modularization helps move some of the onus of testing onto the factory and component vendor. A valid expectation is therefore for components, whether hardware or software, to have been tested before arriving at a building for installation. The most important aspects to then verify and commission on-site will be those that have been affected by the installation process. For example, checking wiring and panel connections is very important as is verifying that any on-site software downloads and/or configurations have been successful. Pre-calibrated sensors are reducing the need for wide-scale sensor validation but an important and related commissioning task is to check whether points have been correctly mapped into the control logic.

In addition to commissioning the control system itself, the control system can also be used as a tool for carrying out commissioning on the energy systems. A control system can serve as a commissioning tool by making use of its ability to manipulate energy systems through interfaces such as actuators and switches. The idea is to carry out tests that involve making changes to a particular system through the control system rather than by direct manipulation. Sensors connected to the control system allow the effects of changes to be measured and recorded. Different levels of automation can be applied when using the control system as a commissioning tool. A human operator can perform tests through a user-interface portal or test procedures can be programmed into the control system and be activated by a user. Varying degrees of automation can also be employed in the analysis of test results.

In this chapter, we only focus on ways that the control system can be used to assist in the commissioning process. Procedures such as manually checking sensor calibrations and wiring are beyond the scope of this chapter because they involve performing commissioning on the control system but do not involve using the control system to assist in the process. Manual commissioning of the components in a control system was treated in Chapter 4.

The chapter is organized as follows. Section 5.2 summarizes the results of surveys that were carried out in four countries on issues related to control system commissioning. Section 5.3 describes methods that use the control system for commissioning. Section 5.4 discusses ways to implement commissioning tools and highlights practical issues and Section 5.5 summarizes the tools that have been developed by Annex 40 participants. Conclusions are presented in Section 5.6.

## **5.2 RESULTS OF PRACTITIONER SURVEYS**

A questionnaire was prepared by the Japanese team in order to assess current practice with regard to control system commissioning and also to ascertain the demand for tools that could help in the process. The questionnaire was distributed to practitioners in four countries: Japan, USA, Canada, and France. Comprehensive results compiled from the questionnaire responses are presented in (H. Yoshida *et al.*, 2004). Brief summaries of the main findings are presented below for each country.

### **5.2.1 JAPAN**

One of the most common issues identified by respondents in Japan was that, of the tools already available, too much data was required for configuration before they could be used (Yoshida, 2004). This was viewed as one of the main barriers preventing practitioners from starting to use commissioning tools. Also, commissioning and testing features that were already built into the control system were seen as being too complicated and not easy to use. Insufficient documentation and training was also highlighted as a problem in getting practitioners to use new technology more widely. Respondents in Japan also emphasized the importance of making it easier to handle trend data, set-up databases, and perform analyses. A lack of standardization with regard to point names, data access, and visualization was identified as an important problem.

### **5.2.2 USA**

Individuals from six different firms completed ten surveys in the USA (Haas, 2004). Most of the respondents (6) had over ten years of experience with no one having less than three to five years of experience. Most buildings that were selected for the survey fell into the complex critical or large commercial building categories where respondents had the most experience.

For the projects selected, respondents indicated that the most difficult documents to obtain to assist them in the commissioning process were the factory inspection documents from the control system manufacturer. When asked to estimate work percentages for commissioning steps, about 55% fell into categories of “Collecting information” and “Testing, Adjusting and Balancing work”. Examples of other areas where significant time was used were: 11.1% “Waiting or time wasting” and 8.7% spent on “Education and training of maintenance personnel”. All respondents said they used data for comprehensive functional performance testing at the local controller level. Most said they recorded the “Real time data taken from components” and/or from “Engineering parameters stored in components”. Asked whether a simulation tool would be effective for testing the control system, only one respondent indicated an interest. Two survey questions asked about training for operating personnel. In both instances, the answers indicated that less time and effort is given to training as part of the commissioning process than other steps.



### 5.2.3 CANADA

Commissioning tools currently in use in Canada are limited to document templates intended for the construction and acceptance phases of projects (Corsi *et al.*, 2001). Automatic tools were almost non-existent or were at the early stage of research. The responses to the questionnaire indicated that a demand does exist for (automated) tools to assist commissioning but that there are barriers to their adoption. The responses indicated certain features that a commissioning tool should have in order to be beneficial. In particular, commissioning tools should be able to demonstrably reduce costs and reduce the need for technical expertise on site. Tools should also automate parts of the testing process that are most labor intensive and repetitive. Furthermore, benefits of tools need to be easily quantifiable to encourage adoption.

### 5.2.4 FRANCE

More than thirty responses were obtained from the French survey (Vaezi-Nejad *et al.*, 2001). The respondents included building owners, design engineers, installation contractors, control system manufacturers, and maintenance contractors. The survey results are summarized below.

- There was demand for the control system to be better utilized in the commissioning process.
- Several areas were identified that could be improved to make commissioning more effective: organization (complexity of the organization), awareness and motivation (budget and time constraints), skill and expertise (division of the tasks and the systematic use of sub-contractors), legal aspect (contractual situation concerning installation checking is not well defined), technical aspects and documentation (methods to check the control system are not specified).
- Taking into account the constraints of the different participants in the commissioning process is an important issue.

The responses indicated that it is important to define standard design documents (i.e., sequence of operations), procedures for checking, calibrating and tuning, methods and tools to assess functional performance, automatic or semi-automatic embedded functions to help in commissioning (self-checking, self-tuning, self-configuring), and benchmarking procedures or tools.

## 5.3 METHODS TO COMMISSION THE CONTROL SYSTEM AND ENERGY SYSTEMS

This section summarizes the different approaches developed during Annex 40 for carrying out commissioning activities using the control system. The methods described in this section have been developed and tested by interfacing to the control system through the controller workstation or higher-level supervisory controllers. However, because the methods mostly reside in software programs, they could, in principle, be implemented in any microprocessor-based device with sufficient resources that is connected to the control system network. The methods developed during the Annex project have also been tested mainly during the building occupancy & operation phase.



### 5.3.1 TYPES OF COMMISSIONING TESTS

Two approaches to commissioning using the control system that have been considered in Annex 40 are passive test and active test. Passive tests involve using the control system to monitor and record sensor and actuator signals from energy systems operating under normal conditions (Choiniere, D and Corsi, M. 2003a). These tests are non-invasive in that they do not introduce any artificial disturbances into the systems. The most important aspects of passive testing are to properly select points to monitor and to apply appropriate data analysis methods. Active testing involves making artificial changes to the systems under control in order to interrogate behavior. Active tests can reveal more information about a controlled system in a shorter time period than passive tests, but can be more expensive to implement (Bornside, 2003; Salsbury and Singhal, 2004).

#### ***Criteria for deciding between active & passive test***

A detailed analysis of the different approaches to commissioning is given in (Vaezi-Nejad *et al.*, 2004a). Table 5 presents the criteria that influence the selection of the appropriate commissioning type.

	<b>Passive test</b>	<b>Active test</b>
Commissioning types	On-going	Initial, re and retro
Level of automation of the tool	Manual to automatic	Manual to automatic
Tool location	Stand-alone, embedded	Stand-alone
BEMS communication with other platform	Read	Write – Read
Data monitoring	Long-term monitoring	Short-term monitoring
Knowledge of the users	Medium	High
Impact on the building operation	None	High
Commissioning budget	Low	High

**Table 5: Passive/active test decision criteria**

### 5.3.2 EXAMPLE METHODS

Various types of methods have been considered in Annex 40, including: model-based, expert rules, graph technology, functional test sequences, and performance indices. Some of the methods were also evaluated as part of IEA Annex 34 (Pakanen *et al.*, 2001). This section describes the different approaches using examples based on tools developed during Annex 40.

## Model-based

The model-based method involves comparing predictions of a model with the measured performance of a component or system, as illustrated in Figure 15 (left). Significant differences indicate the presence of one or more faults. Figure 15 (right) shows the specific case of a heating coil. The inputs to the model are the measured inlet air and water temperatures and the control signal. A model of the coil, valve and actuator predicts the outlet air temperature, which is then compared to the measured value.

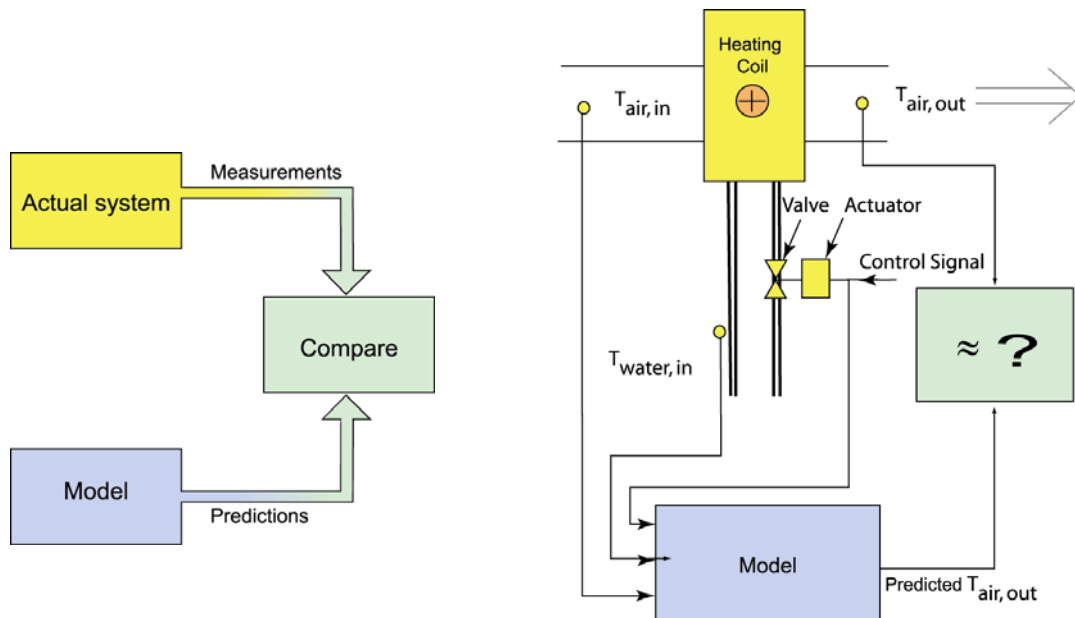

**Figure 15: The concept of model-based fault detection and its application to a heating coil**

A number of model-based commissioning methods that are intended to interface to the control system have been explored in Annex 40 (Kelso and Salsbury, 2002). Chapter 6 also provides a more comprehensive discussion of model-based commissioning and presents a library of models that can be used for Functional Performance Testing.

## Rule-Based

A rule-based method is based on the transcription of physical and logical prior (expert) knowledge of a system into a set of rules, e.g., IF/THEN. The rules should duplicate the same reasoning that an expert would use. A rule-based method for commissioning was developed by the USA & French teams and is described in (Castro *et al.*, 2003). The method comprises three main steps and these are described below.

- 1) Define the operating mode of the AHU by using control signal information. For an AHU we have defined different operating modes: (1) Heating, (2) Free Cooling, (3) Mechanical Cooling with minimum outside air, (4) Mechanical Cooling with 100% outside air, stop of the ventilation, frost protection.

2) Apply rules according to the specific mode. The rules are based on 3 main types of fault:

- Inconsistency between two measured values for a specific mode (example  $T^{\circ}$  supply air  $>$   $T^{\circ}$  mixed air in heating mode)
- Inconsistency between measurements in case of redundancy (example  $T^{\circ}$  supply air  $\neq$   $T^{\circ}$  mixed air in Free Cooling mode)
- Inconsistency between setpoint and its measured value (example  $T^{\circ}$  supply air  $>$   $T^{\circ}$  supply air setpoint)

An example of application of the table of inconsistencies between two measured values for heating mode ( $Toa$ : outside air temperature,  $Tsa$ : supply air temperature,  $Tma$ : mix air temperature) is shown in Table 6.

Heating Mode	Toa	Tsa	Tma	Tra
Toa		$Toa > Tsa$	$Toa > Tma$	$Toa > Tra$
Tsa			$Tsa < Tma$	?
Tma				$Tma > Tra$
Tra				

Table 6: Example decision logic for heating mode

3) Define the diagnostic adapted to the violated rule. Example diagnostics are presented in the Table 7.

Heating Mode	Toa	Tsa	Tma	Tra
Toa		- Sensor fault : Tsa or Toa - Cooling Coil valve leakage	- Sensor fault : Tma or Toa	- Sensor fault : Tra or Toa
Tsa			- Sensor fault : Tsa or Tma - Cooling Coil valve leakage	?
Tma				- Sensor fault : Tra or Tma
Tra				

Table 7: Example diagnostics

### **Performance index-based method**

Performance indices are calculated values or control values that quantify the performance of a control loop, component, or system. The performance index-based method applied to real time commissioning involves comparing indices of similar controllers or components under specific conditions (outside air temperature, humidity, etc.) or under a specific period (instantaneous, one hour, one week), as illustrated in Figure 16. Performance index values can be normally distributed. Limits can be set to define a range of values corresponding to acceptable behavior and values that lie outside the range can indicate that a problem exists. Performance index values can also be used to optimize set points and improve system performance. Limits can be manually set or be estimated continuously. Performance indices can be analyzed by expert rules aided by control values and parameters to diagnose faults. A performance index-based method for commissioning was developed by :

- the Canadian team and is described in (Choiniere, 2003a)
- the French team and is described in (Vaezi-Nejad et al., 2004b)
- the Dutch team and is describe in (Elkhuizen et al; 2004).

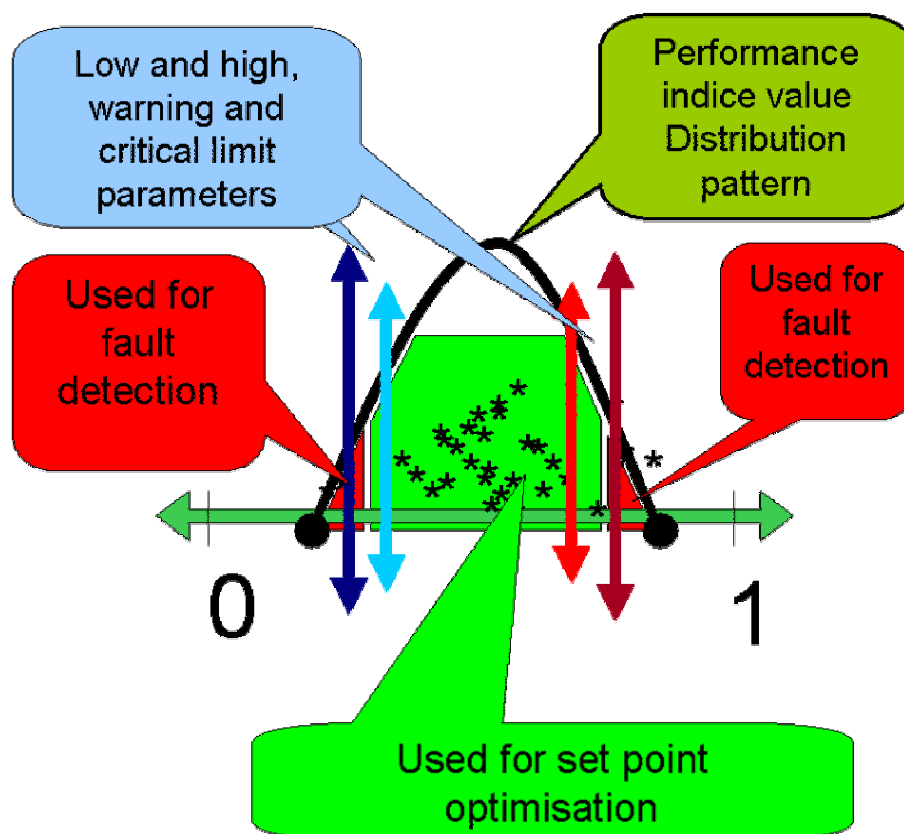

Figure 16: The concept of performance index-based method (the Canadian approach)

## Logic Tracer

The Japanese group developed a tool for checking the operation of control logic (Shioya et al., 2004). The tool focuses on sequences of operation and is called the Control Logic Tracer (CLT). The tool allows control algorithms to be visualized via a graphic tool Microsoft Visio™. The CLT reads operational data in XML<sup>2</sup> format and displays the control sequence as a diagram using colored lines to actively indicate the current control path (see Figure 17). The main benefits of the CLT are that it:

- provides BEMS designers and building operators with easy-to-understand information about HVAC control logic;
- allows users to visualize the sequence of HVAC control over time;
- diagnoses failures by tracking down the causes traceable to the system control and provides the user with valuable information to correct operation or control failures in a HVAC system.

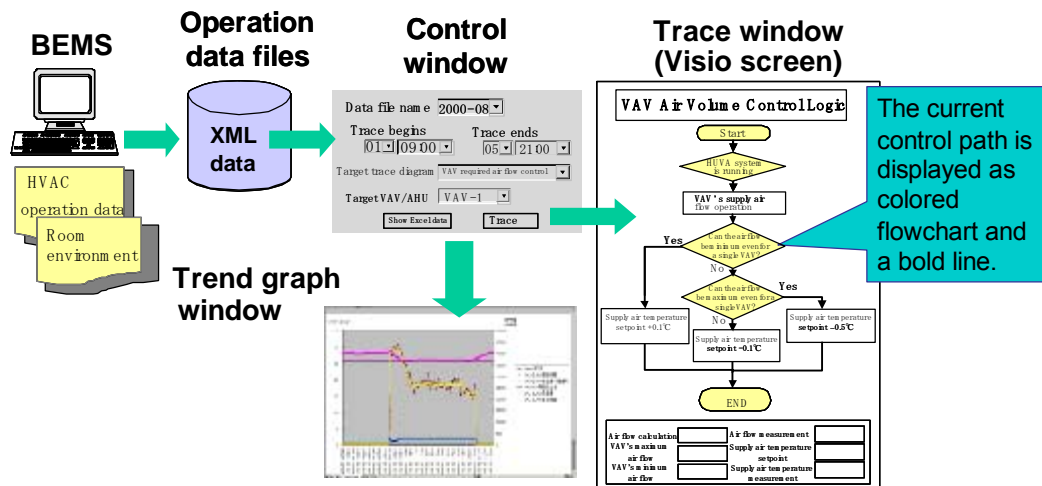

Figure 17: General configuration of HVAC Control Logic Tracer

<sup>2</sup> eXtensible Markup Language

## 5.4 IMPLEMENTATION OF AUTOMATED COMMISSIONING TOOLS

A commissioning tool can be implemented in the control system or in a separate hardware device such as a laptop computer that would be temporarily attached to the control system. The main elements of a commissioning tool include architecture, level of interface to the control system, method used, data management, data communication and user interface.

### 5.4.1 ARCHITECTURE TYPES

As shown in the Figure 18 building systems consist of HVAC components that are organised in subsystems (HVAC groups). Every HVAC unit includes a number of sensors. Each sensor has a unique address and provides data to a control Panel or central control network. The control panel can include other information describing the building system. Information from the control panel can be stored in a general database that could be used by different building optimization software such as an FDD tool, an automatic commissioning tool, or a trending tool (Vaezi-Nejad *et al.*, 2004a; Cantave, R.,2003; Choiniere *et al.*, 2003b).

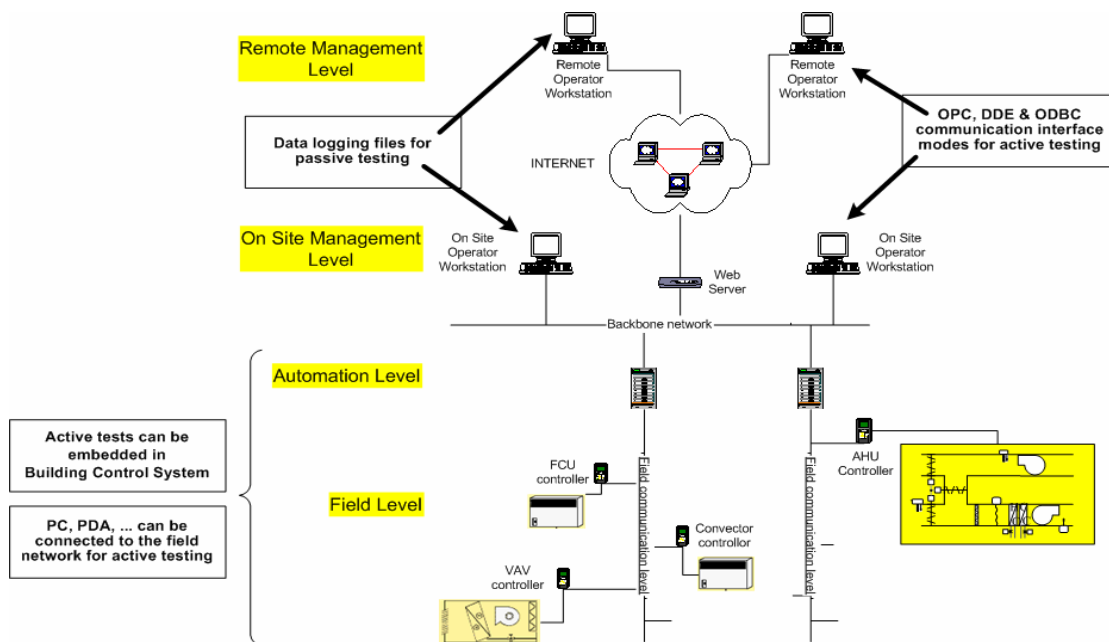

Figure 18: Architecture and communication protocols

A commissioning tool could be embedded in the control system or connected directly to it in order to use existing measurement and communication equipment in a building and reduce cost and time for commissioning tasks. When connected, the tool could reside on the operation workstation or could be in a remote site. Table 8 lists different architecture types.

<b>Tool Architecture</b>	<b>Location</b>	<b>Communication</b>
Stand alone	Remote Management Level, Remote operator workstation	Via Internet or phone network
Stand alone	On site Management Level On site operator workstation	Via Local Area Network
Stand alone or Embedded	Automation level Local Controllers & outstations	Automation communication level or Additional Instrument connected to the backbone network (LAN)
Stand alone or Embedded	Field level Terminal & room Controllers	Field communication level Additional or Instrument connected to the field network

**Table 8: Types of architecture**

#### **5.4.2 COMMUNICATION ISSUES**

A practical barrier to the adoption of commissioning tools is the difficulty of setting up communications between the tool and the control devices. From a tool developer's standpoint, control systems that use open protocols can greatly simplify the implementation.

As part of Annex 40, the US National Institute of Standards and Technology (NIST) developed a commissioning test shell that establishes communication links with a control system using the BACnet communication protocol (Castro *et al.* 2003). The test shell can actively override control system commands to invoke functional performance tests using a scripting capability.

#### **5.4.3 DATABASE**

A database is a central component of a commissioning tool that can have a direct impact on tool performance. Databases can include a knowledge base used by the tool, commissioning models, performance test libraries, internal tool relationships, building and HVAC system configuration data, commissioning parameters (design data, sequences of operation, internal tool, etc.), operating control values, and finally the commissioning results. For an on-going commissioning tool, the database should have the capacity to store data for many months and years. In Annex 40, most of the tools that were developed use relational database such as a SQL server.

#### **5.4.4 USER INTERFACE EXAMPLES**

##### ***DABO Diagnostic and Cite-AHU tools***

The two following figures show example user interfaces for a commissioning tool developed by the Canadian team (Figure 19) (Choiniere D and Corsi M. 2003a) and the French team (Figure 20) (Castro N. and Vaezi-Nejad H., 2004). The interface allows the user to enter system configuration data and invoke various fault detection modes. It also facilitates data communication and management between the building control system, database and commissioning module, as well as generating reports and getting online help. To be effective, an interface should be: (1) reliable, (2) easy to use, (3) easy to engineer, (4) maintain, (5) configure and (6) understand. It should allow good interactivity with the user and be visually well designed.

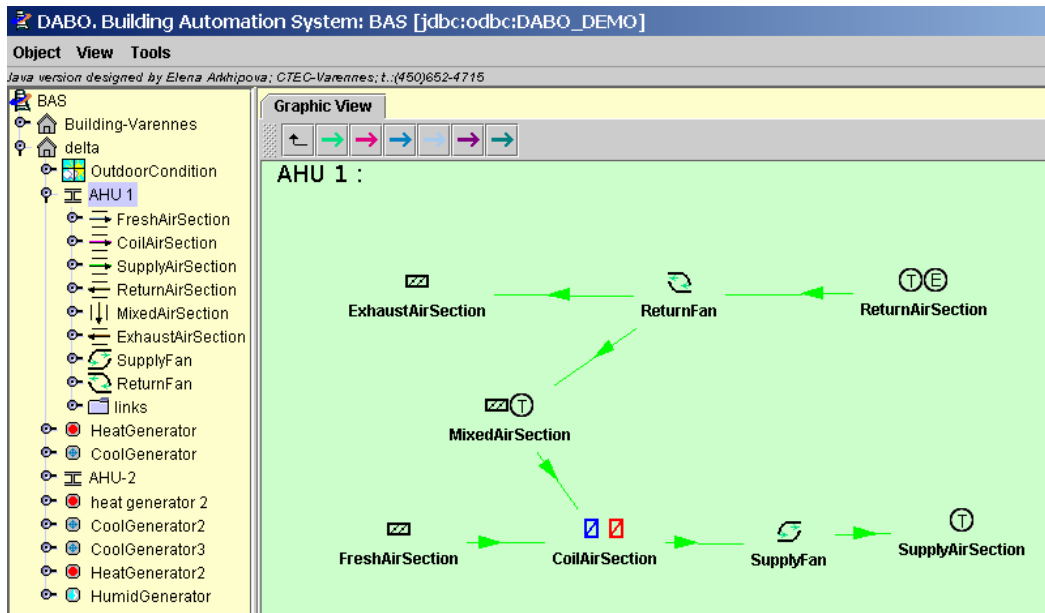

Figure 19: DABO-AHU configuration

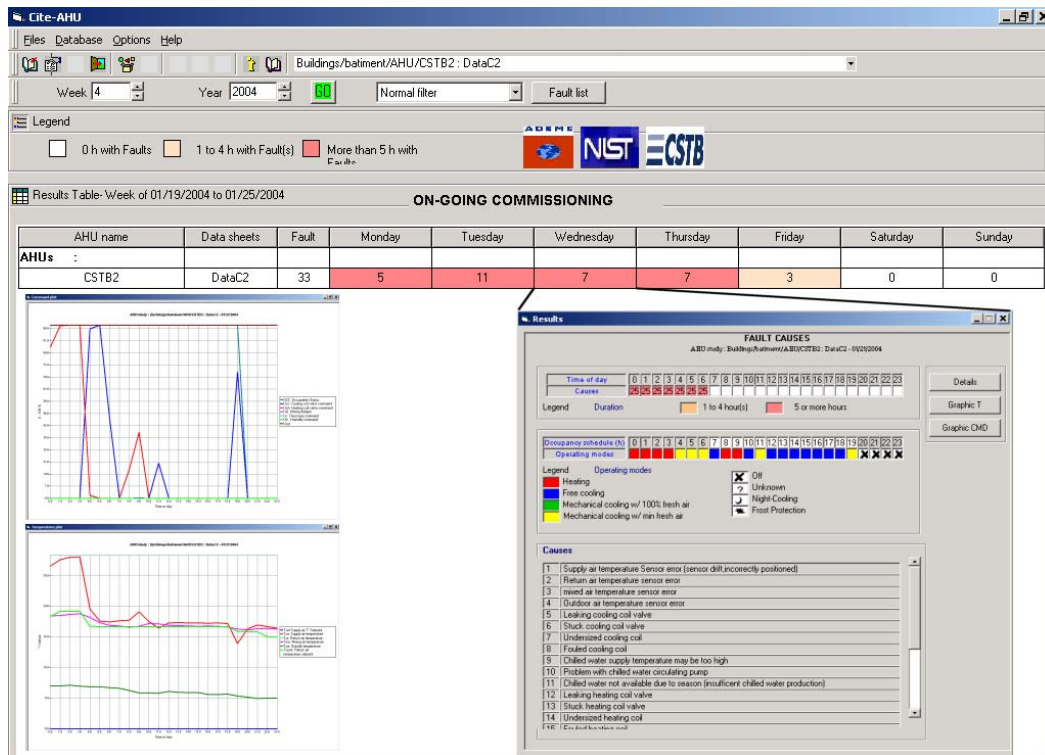

Figure 20: Cite-AHU tools interface

### Operation Diagnostics

Operation Diagnostics uses enhanced visualization techniques to indicate and analyze information that is inherent in data from a control system. Data are collected from the control system and visualized in the form of operational patterns. The operational patterns are generated by PIA, a visualization toolbox developed by Per Isakson, (Isakson et al., 2004; Carling *et al.*, 2004) from the Royal Institute of Technology in Stockholm, Sweden.



## 5.5 DATA HANDLING

An SQL database is used to access control system data and the interface allows data to be imported from different control systems. During the import, data are checked for consistency (missing data is filled with 'not a number' information - NaN) and plausibility (non-plausible data causes warnings). Data sets with different time ranges are joined together and duplicate data are deleted. Once a database is constructed, data can be filtered and exported in a format suitable for PIA. The database also holds information about sensor location (building, story, room, facility), threshold values for plausibility checks, minimum and maximum values for visualization scales, etc. Figure 21 presents an example of an SQL database.

Langtext	Gebäude	Raum/Anlage	Gruppe	Untergruppe	Daten vorhanden	Hausadresse
a137m077	RM Stellsignal Volumenstromr.	A03 ANL137	C225	Stellsignal	Volumenstromregler	1 A03C225-Y03.RM
a137m079	RM Minimal/Standby/Komfort	A03 ANL137	C225	Betriebsart	Minimal/Standby/Komfort	A03C225-Min/Stan
a137m085	ber. Sollwert Zuluft	A03 ANL137	C225	Temperatur	Zulufttemperatur	1 A03C225-B01.XSC
a137r082	Zeitpr.1 Belegungszeiten	A03 ANL137	C225			1 A03C225-ZP1
a137r083	Zeitpr.2 Raum spülen	A03 ANL137	C225			1 A03C225-ZP2
a137r084	Zeitpr.3 Blockierschutz Pumpe	A03 ANL137	C225			1 A03C225-ZP3
a137s067	RM Betrieb Erhitzerpumpe	A03 ANL137	C225			1 A03C225-M02.ST
a137s068	RM Aussenluftklappe AUF	A03 ANL137	C225			1 A03C225-Y04.ST
a137s073	RM Betrieb Zuluftventilator	A03 ANL137	C225			1 A03C225-M01.ST
a137s076	RM Präsenzmelder	A03 ANL137	C225			1 A03C225-F02.ST
a137s086	RM Betrieb Anlage	A03 ANL137	C225			1 A03C225-ST
a032m170	Meßwert Windstärke	A04 ANL32	N01-			1 A04N01-B03.ME
a032m171	Meßwert Globalstrahlung	A04 ANL32	N01-			1 A04N01-B05.ME
a032m188	Meßwert Außenluftfeuchte	A04 ANL32	N01-			1 A04N01-B02.ME
a032m189	Meßwert Lichtstärke Nord	A04 ANL32	N01-			1 A04N01-B09.ME
a032m190	Meßwert Lichtstärke Ost	A04 ANL32	N01-			1 A04N01-B06.ME
a032m191	Meßwert Lichtstärke Süd	A04 ANL32	N01-			1 A04N01-B07.ME
a032m192	Meßwert Lichtstärke West	A04 ANL32	N01-			1 A04N01-B08.ME
a032m194	RM Regen/Wolke/Sonne	A04 ANL32	N01-			1 A04N01-Wetter
a033b211	Zeitprogramm Ferien	A01 ANL33	A05			1 A01-A05-ZP.Ferien
a033m011	AU-Temp. A04 Wetterstation	A04 ANL33	N01-			1 A04N01-B01.ME
b001a085	Störung Pumpe HK02	A01 ANL1	H02-			1 A01H02-M01.AL
b001a095	Störung Pumpe HK03	A01 ANL1	H03-			1 A01H03-M01.AL
b001a105	Störung Pumpe HK04	A01 ANL1	H04-			1 A01H04-M01.AL
b001a113	Störung Ablüfter	A01 ANL1	L02-			1 A01L02-M01.AL
b001a114	Rep.-Schalter Ablüfter AUS	A01 ANL1	L02-			1 A01L02-Q01.AL
b001b066	ZP-1 Kühlung	A01 ANL1	H200			1 A01H200-ZP1
b001b087	Zeitprogramm Nachtabsenk.	A01 ANL1	H02-			1 A01H02-ZP2
b001b151	Betriebsart RWA-Fenster Linie 1	A01 ANL1	N01-			1 A01N01-RWA1.BA
b001b152	Betriebsart RWA-Fenster Linie 2	A01 ANL1	N01-			1 A01N01-RWA2.BA

Figure 21: SQL database with selected data points (blue lines).

## 5.6 DATA VISUALIZATION WITH PIA

PIA is a collection of tools for enhanced data visualization. Time series plots can be produced with a Data Browser. In addition to conventional line plots, data can also be displayed as carpet plots. For a carpet plot, data are transformed into a color scale. Data from each day are then displayed in separate columns. Carpet plots allow large amounts of data covering periods of several weeks or even months to be displayed simultaneously. Also, snapshots of data from certain times each day can be displayed in order to focus on critical periods of operation such as start-up and shutdown. At present, the Data Browser can only handle data with a sampling period of 5 minutes. Figure 22 presents an example of a carpet plot.

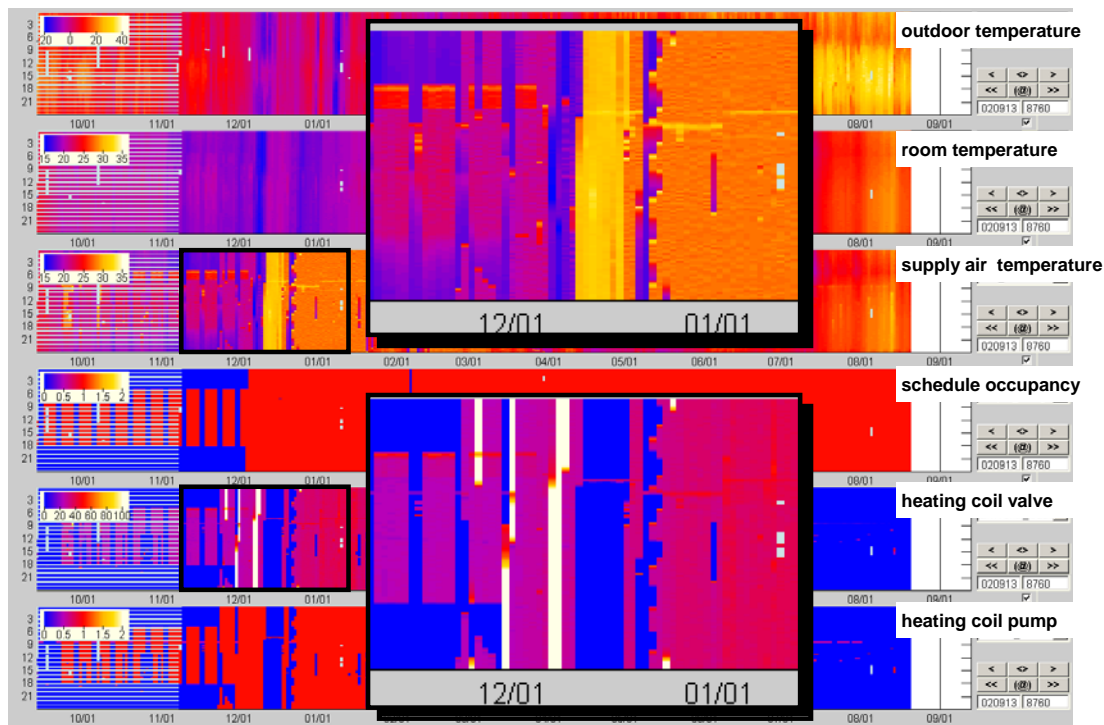

**Figure 22: Carpet plot of 6 data points for a time range of 11 months**

The data can also be displayed in scatter plot form using pmBrush. A single scatter plot allows the dependency of 2 data points to be analyzed whereas a matrix of scatter plots allows analysis of the dependency of  $n \times m$  data points (where  $n \times m$  is the size of the matrix). A brushing function allows the user to interactively select data points and save the selections for use in subsequent calculations. Selected points are highlighted in all the scatter plots of the matrix.

Further development will connect the database with the visualization tools directly. Also there is need to extend the interface to different types of control system, and to improve the plausibility checks that are carried out automatically. Figure 23 presents an example of a scatter plot matrix.

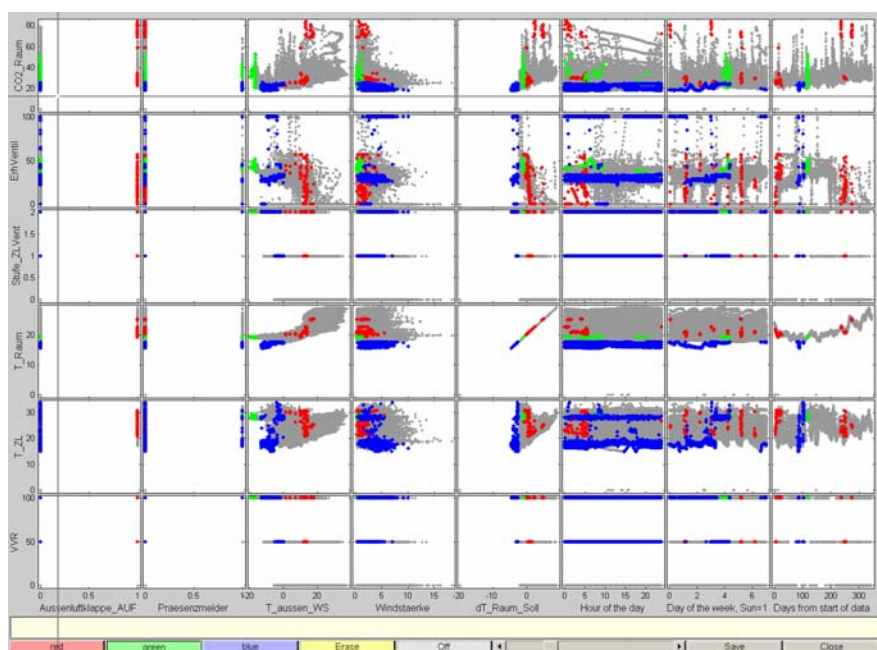

**Figure 23: Scatter plot matrix**

## 5.7 TOOLS TESTED DURING THE ANNEX

Prototype software has been developed that enables the automation or semi-automation of Functional Performance Testing. The prototypes are developed sufficiently to enable testing in real commissioning projects in collaboration with the envisioned users of the tools. Table 9 lists the tools developed and tested during the Annex 40 project.



	Commissioning tool	Main End-Users								Building Type	HVAC System	Type of Cx	Method	Communication with BEMS
		Building Operator	Energy Service Company	BEMS Installer	Building Owner	Mechanical Installer	BEMS Designer	Maintenance Company	Commissioning Agent					
	DABO	<input checked="" type="checkbox"/>	<input checked="" type="checkbox"/>						<input checked="" type="checkbox"/>	Large commercial buildings	AHU VAV	On-going Cx	Expert system performance indice	<a href="#">ODBC</a> and Bacnet driver
	CLT	<input checked="" type="checkbox"/>		<input checked="" type="checkbox"/>					<input checked="" type="checkbox"/>	Any type	Any type	Any type	Emulation	<a href="#">XML</a>
	Cite-AHU	<input checked="" type="checkbox"/>	<input checked="" type="checkbox"/>						<input checked="" type="checkbox"/>	Medium and Large commercial buildings	AHU	Re-Cx	Expert rules	<a href="#">OPC</a>
	WebE	<input checked="" type="checkbox"/>			<input checked="" type="checkbox"/>				<input checked="" type="checkbox"/>	Any type	Any type	On-going Cx	Performance indice	
	Ecole Cx	<input checked="" type="checkbox"/>	<input checked="" type="checkbox"/>							Medium buildings	Hydronic heating	On-going Cx	Expert rules	ASCII and EXCEL® files
	Macro-CX	<input checked="" type="checkbox"/>	<input checked="" type="checkbox"/>						<input checked="" type="checkbox"/>	Any type	Any type	Re-Cx	Performance indice	<a href="#">ODBC</a> and Bacnet driver
	Phil tool	<input checked="" type="checkbox"/>			<input checked="" type="checkbox"/>				<input checked="" type="checkbox"/>	Any type	AHU		Model based	
	OHC-AHU	<input checked="" type="checkbox"/>	<input checked="" type="checkbox"/>						<input checked="" type="checkbox"/>	Large commercial buildings	AHU	Re- Cx	Model based	Data file and Bacnet driver

Table 9: Tools tested during Annex 40

### Explanation of acronyms used in Table 9

<b>CLT:</b>	Control Logic Tracer	<b>MI:</b>	Mechanical Installer
<b>Ecole-Cx:</b>	Commissioning tool for schools	<b>BS:</b>	BEMS Supplier
<b>WebE:</b>	Web-based commissioning	<b>BI:</b>	BEMS Installer
<b>OHC-AHU:</b>	Optimal Heating Curve AHU	<b>BD:</b>	BEMS Designer
<b>BOp:</b>	Building Operator	<b>CA:</b>	Commissioning Authority
<b>BOw:</b>	Building Owner	<b>ODBC:</b>	Object Database for Connectivity
<b>MC:</b>	Maintenance Company	<b>OPC:</b>	Object Linking and Embedding for Process Control
<b>ES:</b>	Energy Service Company	<b>XML:</b>	eXtensible Markup Language

## 5.8 CONCLUSIONS

During our work we have found that control systems in buildings have the potential to greatly improve the commissioning process. In particular, control systems can be used to carry out automated testing on the energy systems in a building in a systematic way. Technologies for carrying out automated commissioning are still in their infancy and very few tools are available for practitioners to use. However, our work has demonstrated that tools can be built using existing infrastructure at relatively low cost. In many cases, tools are software programs can be implemented on most microprocessor-based platforms.

One obstacle to getting tools deployed on a wide scale is the difficulty in setting up communication with control products from different vendors. However, open protocols such as BACnet and LON are making this easier. Also, there is a cost in identifying the correct sensors and command signals on a control system this cost needs to be balanced against the benefits of the automated methods.

## 5.9 REFERENCES

Baumann O., Operation Diagnostics - Verification and Optimization of Building and System Operation by Multi-Dimensional Visualization of BEMS Data, International Conference on Enhanced Building Operations 2003, Berkeley, USA. Ebert-Ingenieure München, Germany, 2003.

Bornside, D., "Global Automated Terminal Testing & Commissioning". Presented at 5th Meeting of Annex 40, A40-C-M5-US-DEB-05.pdf, Kyoto, Japan, 2003.

Cantave R. "Architecture for Implementing Automatic Commissioning Tool ODBC approach for Implementing Automatic Commissioning Tools into Building Energy Management System (BEMS)". Presented at the 6th Meeting of Annex 40, A40-C-M6-Ca-CETC-08.pdf, Berkeley, California, 2003.

Carling P., Isakson P., and Blomberg P., Evaluation of a slab-cooled office building by extensive measurements through the BEMS. Final report for research project: "Evaluation of systems for heating and cooling in the Katsan building". Stiftelsen för arkitekturforskning, 2004.

Castro N., and Vaezi-Nejad H., "Retro-commissioning the aria building using Cite-AHU: an Annex 40 collaboration", PF-6.pdf, ICEBO, Paris, 2004.

Castro N.S., Galler M. A., and Bushby, S.T. "A Test Shell for Developing Automated Commissioning Tools for BACnet Systems" National Conference on Building Commissioning, 2003.

Choinière D. and Arkhipova E. "Architecture for Implementing Automatic Commissioning Tool". Presented at 5th Meeting of Annex 40, A40-C3-M5-Ca-CETEC-05.pdf, Kyoto, Japan, 2003b.

Choinière D. and Corsi M., "BEMS Assisted Commissioning tools to improve the building performance", choiniere\_icebo.pdf, ICEBO, Berkeley, 2003a.

Corsi M. and Choinière D., "Commissioning Practice Practice in Canada", Annex 40 Meeting, A40-A-M1-Ca-CEDRL-01.pdf, Scheveningen, April 2001.

Elkhuizen P.A., Scholten J.E., Peitsman H.C., and Kooijman A., "The effect of optimal tuning of the Heating-/ cooling curve in AHU of HVAC system in real practise, PF-81.pdf, ICEBO, Paris, 2004.

Haas T., "A summary of the major findings from the survey of US commissioning practioners file", 2004.

Isakson P. and Eriksson J., "Vision of a vizualisation tool for commissioning. Proceedings of International Conference on Enhanced Building Operation", Paper no 80, ICEBO, Paris, 2004.

Kelso R. and Salsbury, T., "Commissioning via System Identification and Design Models", Annex 40, A40-CD-M3-USA-JCI-1.pdf, Sweeden, 2002.

Pakanen J., Dexter A. L., and al., "Computer-aided Evaluation of HVAC System Performance: the Practical Application of Fault Detection and Diagnosis Techniques in Real Buildings", source book document IEA-ECBCS, ISBN 951-38-5725-5, Annex 34, VTT, Finland, 2001.

Salsbury T. and Singhal A., "Control System Commissioning for Enhanced Building Operations", Salsbury\_ICEBO.pdf, ICEBO, Berkeley, 2003.

Satu Paiho, Jorma Pietiläinen & Mia Ala-Juusela, 2004, "WEB-BASED Services For Building Energy Management – WEBE", , ICEBO 2004 Paris Oct. 18-19 2004, PF-58.pdf.

Shioya M., Tsubaki M. and Nakahara N., 2004, Study on Commissioning Process for Control Logic of Thermal Storage System, PF-97.pdf, ICEBO, Paris, 2004.

Vaezi-Nejad, H., Jandon, M. 2003, "OPC Approach for Implementing Auto-Commissioning Tools in BEMS", Presented at the 6th Meeting of Annex 40, Berkeley, California. A40-C-M6-F-CSTB-01.pdf.

Vaezi-Nejad, H, Timothy I. Salsbury, Daniel Choiniere, 2004, "Using building control system for commissioning", ICEBO 2004 Paris Oct. 18-19 2004, PF-37.pdf.

Vaezi-Nejad H., Jandon M., Visier, JC., Viaud B. and Clémenton B., "Enquiry on BEMS Commissioning Practices and Users Needs in France", Annex 40, A40-C2-M2-F-CSTB-1.pdf, Scheveningen, 2001.

Vaezi-Nejad H., Detaille Ch., Jandon M. and Bruyat F, "Using Remote Control Systems for the Re-Commissioning of Heating Plants of School Buildings", , PF-28.pdf, ICEBO, Paris, 2004.

Yoshida H., "Using the Building Control System in Commissioning - Needs and Examples from Japan", ASHRAE winter meeting at Anaheim, Seminar 58, Automated Commissioning Tools, CA, 2004.

Yoshida D., Vaezi-Nejad H., Choiniere D. and Wang S, "Requirements for commissioning HVAC systems using BEMS and commissioning the BEMS itself based on questionnaire surveys", PF-101.pdf, ICEBO, Paris,2004.



## 6. USING MODELS IN COMMISSIONING

The use of computer models to analyze the performance of whole buildings, subsystems and components is becoming more common. The most frequent use is for design-related purposes, such as sizing, energy performance and code compliance. Models also form the basis of fault detection and diagnosis (FDD) tools for use in monitoring routine operation. Commissioning is then a natural application of models for two reasons:

1. FDD methods can be applied to commissioning, including active functional performance testing.
2. Models used in design are a quantitative representation of intended performance and hence provide a baseline against which to compare measured performance during commissioning.

Model-based commissioning procedures use mathematical models of whole buildings, components and systems to link design, commissioning and operation; this is discussed in Section 6.1.1. Models can also be used to develop functional performance testing procedures, which can then be performed manually or automated, and this use of models is described in Section 6.1.2. Test procedures developed in this way in the Annex are described in Section 6.1.3.

The use of models at the whole building level is described in Section 6.2.

### 6.1 USING MODELS AT THE COMPONENT LEVEL

#### 6.1.1 MODEL-BASED FUNCTIONAL PERFORMANCE TESTING AND PERFORMANCE MONITORING

The following steps comprise a "use case" for a general purpose, component-level, model-based commissioning tool that can be used both for initial commissioning and for performance monitoring during routine operation:

1. For automated functional performance testing, the model is configured using manufacturers' performance data and system design information. In general, the model parameters will be determined by a combination of direct calculation and regression.
2. An active test is performed to verify that the performance of the component is acceptably close to the expected performance. This test involves forcing the equipment to operate at a series of selected operating points specifically chosen to verify particular aspects of performance (e.g. capacity, leakage).
3. The test results are analyzed, preferably in real time, to detect and, if possible, diagnose faults.
4. If necessary, the test is performed again to confirm that any faults that resulted in unacceptable performance have been fixed. Once the results of this test are deemed acceptable, they are taken to define correct (i.e. acceptable) operation.
5. The model is re-calibrated using the acceptable test results.
6. The tool is used to monitor performance during on-going operation. This will typically be done in passive mode, though active testing could be performed at particular times, e.g. every weekend, after routine maintenance, after system modifications or retrofit, on change of ownership, etc.

### 6.1.2 EXAMPLE FOR APPLICATION OF FUNCTIONAL PERFORMANCE TESTING (FPT)

This process is illustrated in the following example of a heating coil in a constant air volume system that is controlled by varying the inlet water temperature (as opposed to the water flow rate).

#### Configuring the Model

Since the air and water flow rates remain approximately constant during operation, the performance of the coil can be characterized by a fixed overall heat transfer value (UA), which can be determined from the design specification or the manufacturer's data, e.g:

- Inlet air temperature
- Outlet air temperature
- Inlet water temperature
- Air volume flow rate
- Water volume flow rate

In the case of a more detailed model with multiple parameters, the parameters must be determined using data from multiple operating points. The operating points must be carefully chosen to ensure that each parameter is well-determined numerically. If the model is non-linear in the parameters, as most first principles models are, a search-based optimization method is required. Box's Complex Method is one method that has been used successfully in this application.

#### Designing the Test

Operating points are selected to test for common faults.

#### **Faults:**

- **Loss of capacity** – can be defined in terms of effectiveness or approach at specified design conditions
- **Leakage** – can be defined as the fractional water flow rate through the coil when the demanded position of the control valve is zero; **its** effect can be defined in terms of effectiveness or approach at a specified air flow rate
- **Non-linearity** – results in control difficulties, e.g. variations in dynamic response across the operating range; **can** be characterized by the ratio of the maximum gain to the average gain
- **Hysteresis** – results in control **problems**, especially in regions of high gain
- **Actuator/valve** mismatch/maladjustment – travel of actuator and valve do not match, either they have different ranges or the linkage is not correctly adjusted. Possible effects are that the valve does not fully open or does not fully close or that there is a range of control signals, for which **there** is no valve movement. Corresponding problems are loss of capacity, inability to turn the coil off or control difficulties due to integral wind-up.

### **Operating points (demanded valve position):**

- Loss of capacity, e.g. fouling: **100 %**
- Leakage: **0 %**
- Non-linear, e.g. incorrect valve authority: **50 %**
- Hysteresis: **50 %, opening and closing**
- Valve/actuator misadjustment: **5 %, 90 %**

As discussed further in Section 6.1.6, functional tests can either be performed in closed loop, by changing the set-point, or in open loop, by over-riding the feedback controller and forcing the value of the controller output.

### **6.1.3 USE OF MODELS TO DEVELOP FUNCTIONAL PERFORMANCE TESTING**

Models can be used to identify operating points to be included in functional performance testing. In the heating coil example in the previous section, the component is simple enough that the critical operating points can be identified using "expert knowledge" and a model can be used to confirm or optimize these operating points. For more complex components, a model may be needed in order to identify the combination of operating points needed to detect all the faults of interest. A key requirement is that the model be able to simulate each of these faults. A comparison of the predicted behavior over the operating range for the fault conditions and the no-fault condition allows the required operating points to be identified.

In an extension of the process just described, the model can be used to determine the sensor accuracy required to verify correct performance according to specified acceptance criteria or, equivalently, to identify a specified degree of a particular fault. A simple example follows.

#### **Sensor Measurement Accuracy and Fault Detection Sensitivity – Heating Coil Example**

Figure 24 shows the effect of valve leakage on the relationship between air temperature rise across the coil and valve stem position calculated using the heating coil model. The model assumes that the leakage results from an independent flow path. Other assumptions about the nature of the leak result in different relationships between temperature rise and valve position at intermediate values of valve position. The temperature rise when the valve is nominally closed varies between 0 and 10 K, depending on the degree of leakage. If the combined error in the measurements of the entering and leaving air temperatures is 2 K, leakage of 1 % can be detected.



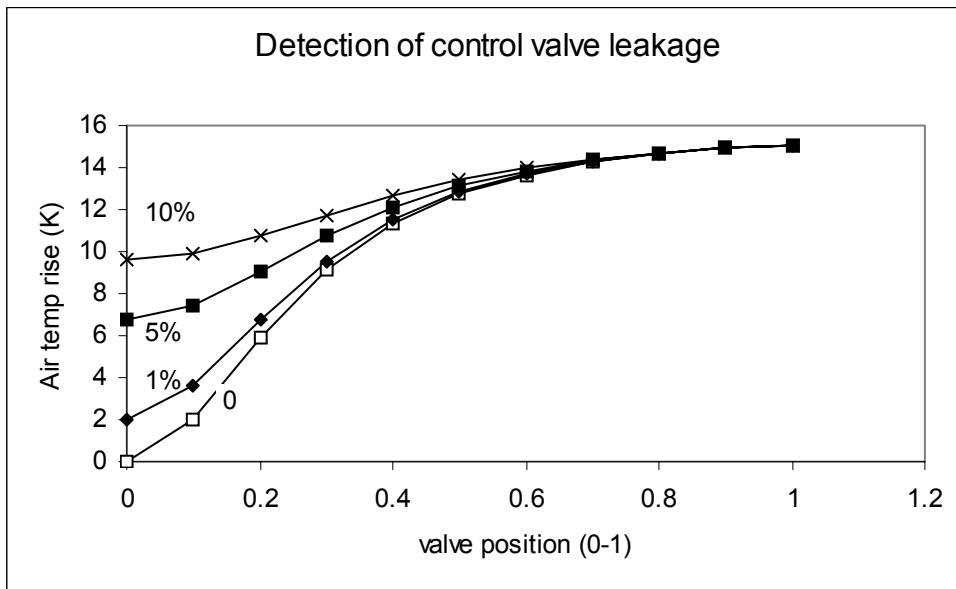

**Figure 24: Heating coil air temperature rise as a function of valve position for different values of valve leakage.**

Figure 25 shows the relationship between coil fouling and the decreased air temperature rise at the maximum duty calculated by the model. A change in temperature rise of 2 K, which is large enough to be detected, corresponds to a change in the UA value of the coil of ~17 %.

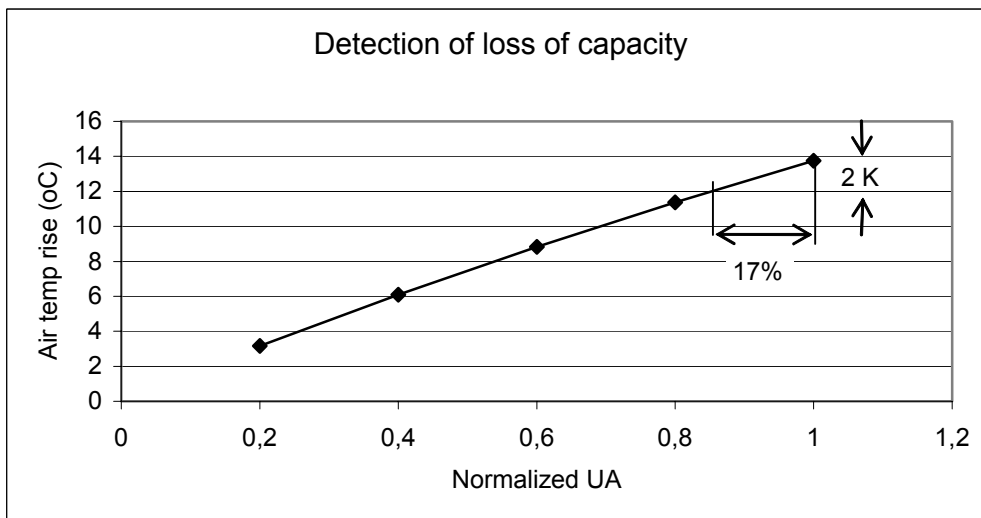
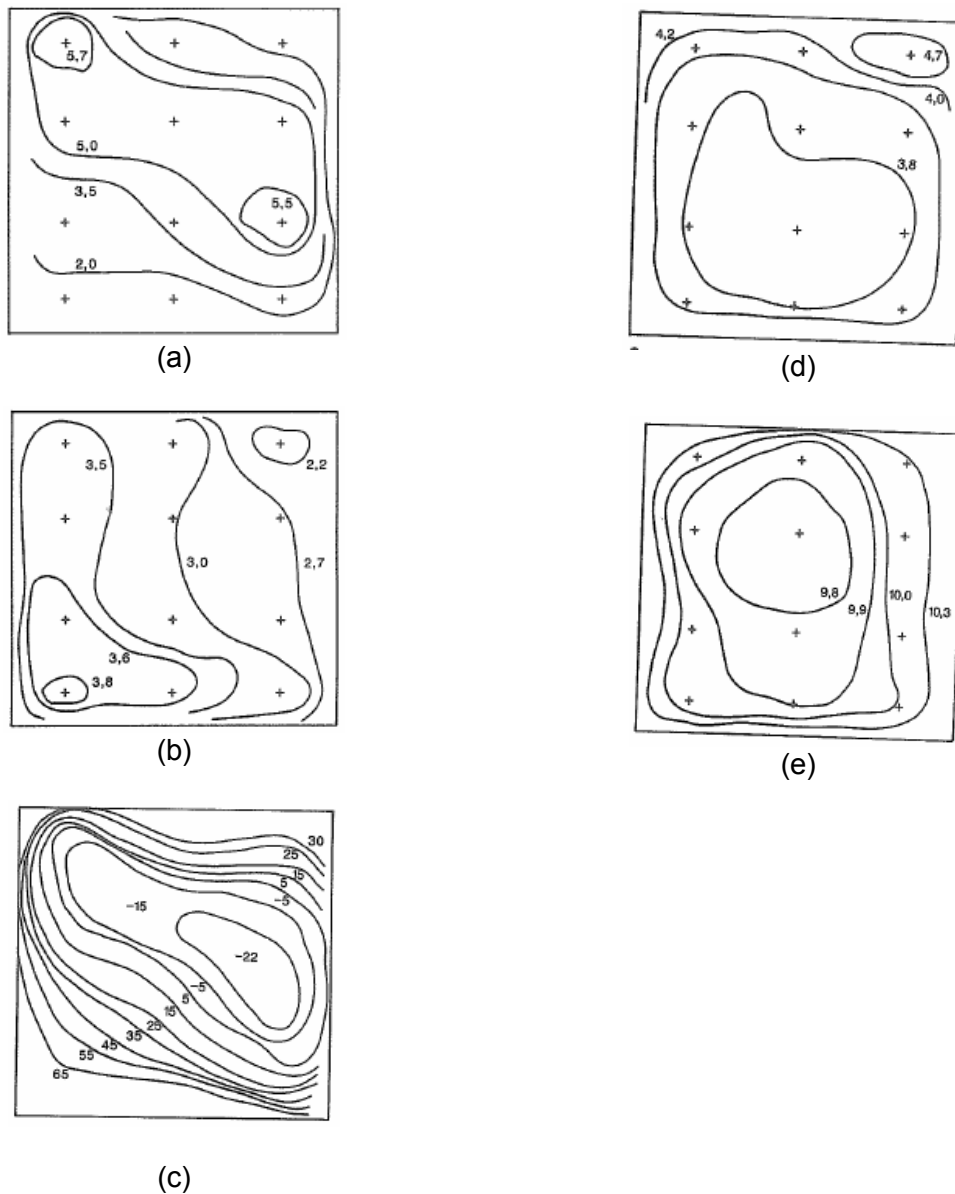

**Figure 25: Heating coil air temperature rise at full water flow as a function of UA.**

#### Sensor Measurement Accuracy Required - Heat Recovery Loop Example

It is difficult to perform measurements on the air side of the heat recovery coils. A study from KTH (Royal Institute of Technology) by /Mundt 1986/ reviews the problems, which are illustrated in Figure 26. It is not possible to perform accurate measurements of the temperatures before and after the coils at one single point; there is a big risk that both the temperature and the air flow vary along the coil surfaces, hence no representative temperature can be found.

Figure 26 shows one example of detailed measurements of temperature (d,e) and velocity (a,b) at cross sections before and after a heat recovery coil. Also presented is the enthalpy transferred to the air by the coil (c) at different locations of the cross section. This enthalpy is calculated by use of additional measurements of the wet bulb temperature.



**Figure 26. Spatial distributions of velocity (a,b), and temperature (d,e) over the duct cross section before (a,d) and after (b,e) a heat recovery coil. The distribution of the resulting enthalpy transfer to the air is shown in (c). Excerpts from /Mundt 1986/**

Based on the difficulty of performing measurements of the air property around the coils, one might come to the conclusion that, instead of making expensive and unreliable measurements on the air side near the coils, it is possible to perform indirect measurements and use calculations to obtain the information required. This approach will be more efficient if accurate simulation models of the components are available.

Information needed to calculate the heat recovery efficiency:

- Supply and exhaust air flow rates:  $q_s$ ,  $q_e$ .
- Temperatures before and after the coils on the supply and return sides,  $T_{si}$ ,  $T_{so}$ ,  $T_{ei}$ ,  $T_{eo}$ .

Additional information needed for model calibration:

- Flow in fluid circuit,  $q_w$ .
- Temperatures in the fluid circuit,  $T_{wh}$ ,  $T_{wc}$ .

A few of these quantities close to the coil can normally be measured with acceptable accuracy:

- Outdoor air temperature in duct inlet  $T_{si}$ .
- Return air temperature at inlet to HVAC unit,  $T_{ei}$ .
- Flow in fluid circuit,  $q_w$ .
- Inlet fluid temperature at the supply coil and inlet temperature at the return coil,  $T_{wh}$ ,  $T_{wc}$ .

To perform the analysis there is still a need to measure either the air temperatures after the coils or the air flow rates. It is expected that the measurement of the air flow rates is more reliable than the temperature measurements but it is likely to be more expensive. If the supply and exhaust air flow rates are known from any kind of measurement, the air temperatures after the coils can be determined using heat balances.

The data needed for the parameter estimation are obtained by measurements and calculation, with uncertainties as shown in Table 10. The outlet air temperatures from the coils are measured to estimate the air flow rates, at as low a fluid flow rate as possible to get as high a temperature difference in the fluid circuit as possible. When the air flow is measured, it is used to calculate the air temperatures.

In the case in which the air flow rate is calculated, the outlet air temperature measurements are responsible for about 50 % of the uncertainty, the fluid flow rate for only 15 % and the other temperatures used in the calculation for about 10 % each. In the example shown, the relative uncertainties in the calculated supply and exhaust air flow rates are 62 % and 52 % respectively. This can be compared to an uncertainty of less than 10 % for tracer gas measurements of the air flow.

Data	Description	Estimated uncertainty
$T_{si}$	Measured	$\pm 0.5$ K
$T_{so}$	Measured / Calculated	$\pm 2$ K / $\pm 2.7$ K
$T_{ei}$	Measured	$\pm 0.5$ °C
$T_{eo}$	Measured / Calculated	$\pm 2$ K / $\pm 2.7$ K
$T_{wh}$	Measured	$\pm 1$ K
$T_{wc}$	Measured	$\pm 1$ K
$q_w$	Measured	$\pm 0.2$ l/s
$q_s$	Calculated	$\pm 52$ %
$q_e$	Calculated	$\pm 62$ %

**Table 10: Uncertainty of the data used for the parameter estimation in this case study**

The relative humidity of the air has a limited impact on the accuracy of the calculation.

An example of the uncertainty to be expected if the outlet air temperatures are calculated from measured air flow rates is shown in Table 11.

<b>Data</b>	<b>Description</b>	<b>Estimated uncertainty</b>
$T_{si}$	Measured	$\pm 0.5$ K
$T_{so}$	Calculated	$\pm 0.85$ K
$T_{ei}$	Measured	$\pm 0.5$ K
$T_{eo}$	Calculated	$\pm 0.85$ K
$T_{wh}$	Measured	$\pm 0.3$ K
$T_{wc}$	Measured	$\pm 0.3$ K
$q_w$	Measured	$\pm 0.05$ l/s
$q_s$	Measured	$\pm 10$ %
$q_e$	Measured	$\pm 10$ %

**Table 11: Uncertainty of the data used for the parameter estimation when more accurate measurements are available.**

#### 6.1.4 USE OF MODELS TO PERFORM INDIRECT MEASUREMENTS

Simulation models can be used at different levels:

- In the experimental design;
- In the analysis (and extrapolation of FPT results);
- In the measurements themselves.

This last possibility is illustrated hereafter:

Measurements of air flow rates are difficult to make in existing distribution networks: long enough straight lines are seldom available or accessible and velocity profiles are usually not uniform enough. A large series of measuring points is required and the final accuracy is often disappointing. A much better solution consists in using the fan as an air flow measuring device. It just requires the use of a classical “phi-psi” model to be tuned on the basis of manufacturer data. The air flow rate then can be determined as function of rotation speed and measured supply - exhaust static pressure difference.

The “phi-psi” model uses the fan similarity laws to normalize the flow rate and the pressure rise. Polynomials representing the normalized pressure rise (psi) and the efficiency as functions of the normalized flow rate (phi) are fitted to manufacturer’s performance data. Attention is paid to the distinction between total and static pressures: manufacturers present fan performance in terms of total pressure rise, whereas the measurements are usually made in terms of static pressures. Attention is also paid to the effects of both atmospheric pressure and air humidity. The air-flow rate is defined in “specific” value (i.e. in kg of dry air per second). Isentropic power and isentropic heating of the air stream can also be calculated to provide additional consistency checks. The use of the model is illustrated in Figure 28 and Figure 27; the model itself is described in detail on the CD (Lebrun 2004d). A simple parabolic psi – phi characteristic appears to be accurate enough for fans with backward-curved blades. The air-flow rate can be determined with an accuracy of about 5 %. In the case of fans with forward-curved blades, the pressure rise is relatively insensitive to air-flow rate and a more accurate result can be obtained by using the efficiency characteristic. The electrical consumption is then a better indicator of the flow rate. However, this approach is not suitable for variable speed fans driven by inverters (variable frequency drives - ‘VFD’s) because variations in the drive efficiency introduce uncertainties into the calculation of shaft power from measurements of electric power.

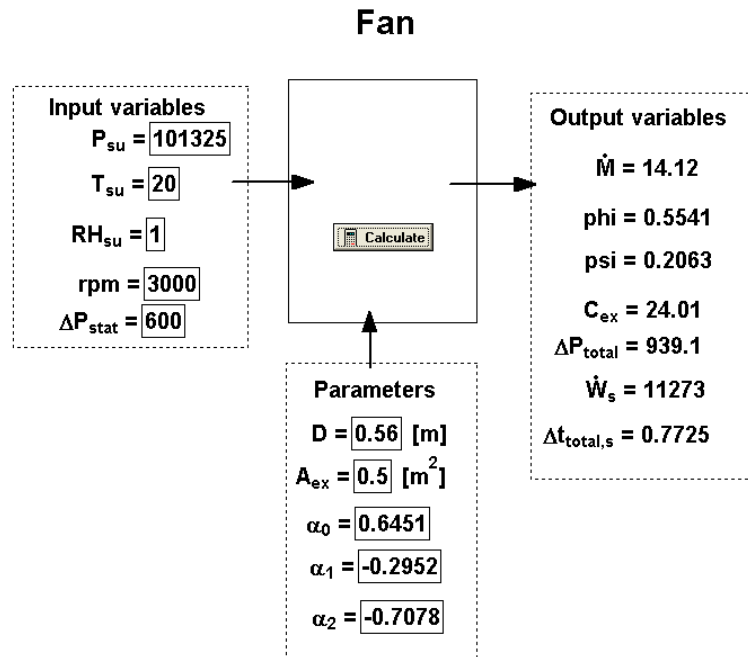

Figure 28: Information flow diagram of the psi – phi fan model

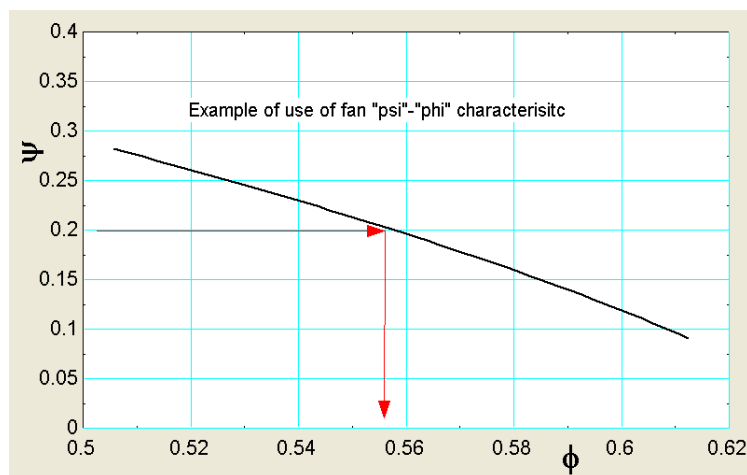

Figure 29: Example of fan curve

If not used in variable speed, a fan with forward oriented blades would present a “better” characteristic in terms of phi – lambda. In that case, indeed, the phi – psi characteristic might be rather “sharp”: the flow rate can vary a lot for a same pressure difference. The electrical consumption is then “telling more”.

### 6.1.5 USE OF MODELS TO PERFORM FUNCTIONAL PERFORMANCE TESTING

A tool for manual commissioning of coil energy recovery loop systems has been implemented in a Tablet PC, by use of the Energy Equation Solver (EES) /Eriksson 2004a/. The tool consists of two parts, the first part is used for estimation of the heat transfer parameters of the heat recovery model, and the second part is use for calculation of optimal fluid flow. For the parameter estimation, there is a theoretical minimum need for one data point for each parameter that is to be determined, but the more data points the better. It is important to have data points for a large range of air and fluid flows. For each data point there is need for information about air temperatures, air flows, fluid flow and fluid temperatures.

When using the parameter estimation tool, the parameters that are calculated can be saved in a file that can be retrieved by the flow estimation tool. In the current version of the parameter estimation tool, it is possible to assume that both coils have the same configuration and then the same calibration parameters. It is also possible to set some of the parameters to fixed values. This can be useful when there is limited data available. A few parameters describing the coils need to be given. They are pipe diameters, number of flow paths and type and concentration of freeze protection added to the water in the fluid circuit. The data used for the calibration are put into EES lookup tables; these can be saved for archival purposes. This tool can also be used to determine the supply and exhaust air flows and the temperatures of the air leaving the coils. The current version of the tool does not take condensation into account.

Data needed for optimization are the supply and exhaust air flow rates and the entering air temperatures. If the fluid flow and fluid temperatures can be measured, the air flows can theoretically be estimated using this tool. Using the tool for air flow estimation must be done with caution.

The tool described above may be extended to an entire air handling unit /Eriksson 2003.

### 6.1.6 AUTOMATED TOOLS TO PERFORM MODEL-BASED FUNCTIONAL PERFORMANCE TESTING

The key elements of an automated tool are:

- a set of suitable models,
- a set of test sequences, and
- supporting software to implement the test sequences and analyze the results using the models

It is also possible for a functional testing tool to be semi-automated. Possibilities include:

1. manual execution, manual data recording and automated analysis,
2. manual execution, automated data recording and manual analysis, and
3. manual execution, automated data recording and automated analysis.

(1) does not rely on the availability of a BEMS. Data are collected by hand and entered into a standalone computer (e.g. a laptop or PDA). (2) uses the normal trending capabilities of the BEMS to collect data that is then analyzed by hand, whereas in (3), the measured data are transferred to an automated analysis tool, which may be integrated with the BEMS or may run in a separate computer. One approach to designing an automated functional testing tool is now briefly described. Further details are presented in /Xu *et al.* 2005.

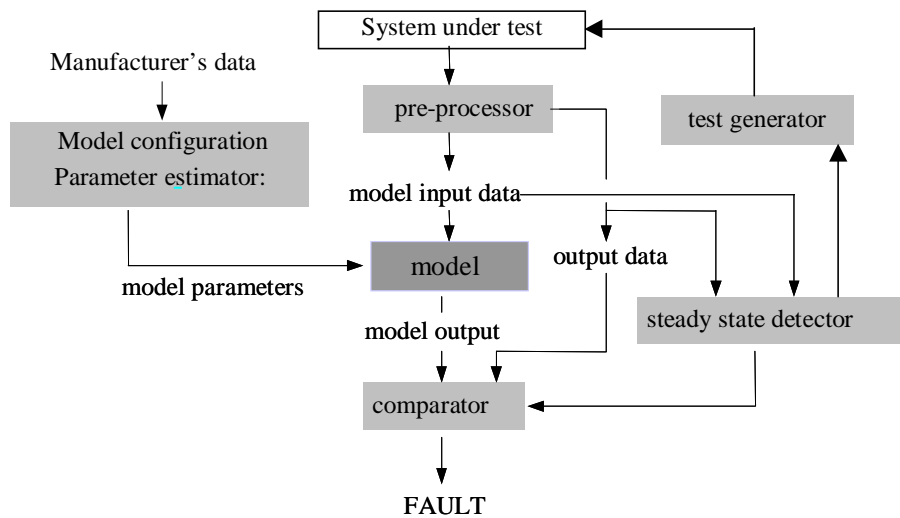

**Figure 30: Architecture of a model-based functional testing tool.**

Figure 30 shows the architecture of the tool. Shaded boxes are software routines. The model is first configured using manufacturer's performance data and design information. The test generator then executes the test by forcing the system to the predefined series of operating points. The test generator waits for the system to come into steady state before proceeding to the next operating point. The tool illustrated in Figure 6.1.6 only performs fault detection; fault diagnosis capabilities may be added in a variety of different ways, which will not be discussed here.

Figure 31 illustrates the operation of the test signal generator. On start-up, the tool requires the user to choose between the closed loop test and the open loop test. If the open loop test is selected, the feedback control loop is then disabled. If the closed loop test is selected, the maximum and minimum values of the set-point are needed as inputs. After that, the program requires the user to input the addresses or names of the control and sensor points. The step test generator will then override the control signal value automatically, based on predefined sequence, as described above. The new value is then uploaded into the controller. The trended data is analyzed in real time to determine whether the system is in steady state. When the system reaches steady state, the tool will move to the next step until the end of the test sequence. The software structure is generic with only the data transfer between control system and the software being vendor-specific.

Figure 32 shows the results of applying the model-based fault detection analysis procedure used in the tool to a mixing box with no deliberate faults. The measurements were made in the course of the development of the method and many more steps were used than would be used in a tool intended for use in practice. The demanded position of the damper actuators and the measurements of the outside, return and mixed air temperatures are shown at the top of the figure. Since there is relatively poor mixing in most mixing boxes, the supply air temperature, corrected for the rise across the supply fan, is used as a proxy for the mixed air temperature. The maximum mixed air temperature is very close to the return air temperature and the minimum mixed air temperature is very close to the outside air temperature, indicating that leakage is small.

In the middle of the figure is a comparison of the measured mixed air temperature and the mixed air temperatures corresponding to the 3:1 gain range that defines the limits of acceptable operation. In the absence of any specific information on acceptable leakage, the values of the acceptable leakage parameters were set to zero. The measured values lie between the permitted upper and lower limits, except when the demanded position of the damper is ~20 %, when the damper fails to open significantly, in part because of hysteresis.

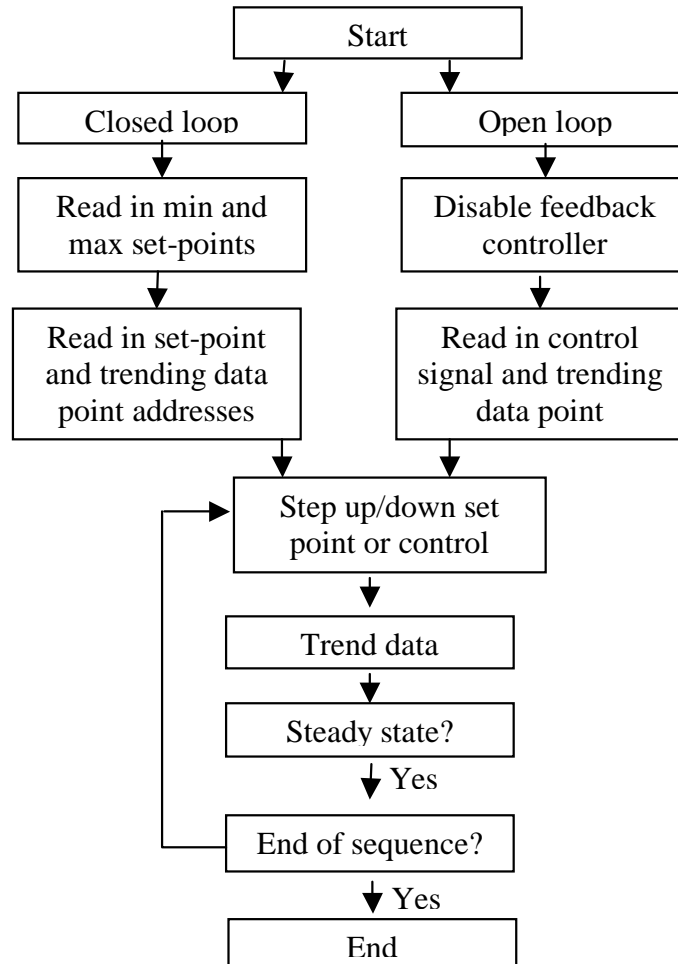

**Figure 31: Automated test signal generator**

Figure 33 shows the result of using the model fitted to measurements from the correctly operating mixing box to detect faults in a mixing box with an artificially induced fault. In this case, the return air damper had been fixed in the closed position by the facility staff, as if the actuator had failed. The outside and exhaust air dampers were closed in 10 % steps and then opened in 20 % steps, as shown at the top of the figure. The third plot shows that the measured performance falls significantly outside the permitted range; which is the comparison that would be performed as part of initial commissioning. Lower down is the comparison of the measured performance and the performance simulated by the model fitted to the correct operation data, which is the comparison would be performed if the functional test were repeated to check performance subsequent to the initial commissioning. At the bottom are the corresponding output of the steady state detector and innovations. The threshold has been increased to 3 °F to reflect the modelling errors that must be considered when the reference model is a fit to performance data.



The innovations significantly exceed the threshold for much of the operating range, indicating the presence of a substantial fault. In both Figure 32 and Figure 33, significant innovations occur at one or more of the control signal values used in the test procedures described in Section 6.1.1 (0 %, 5 %, 50 %, 90 %, 100 %), demonstrating that this fault can be detected with the minimal test signal set described.

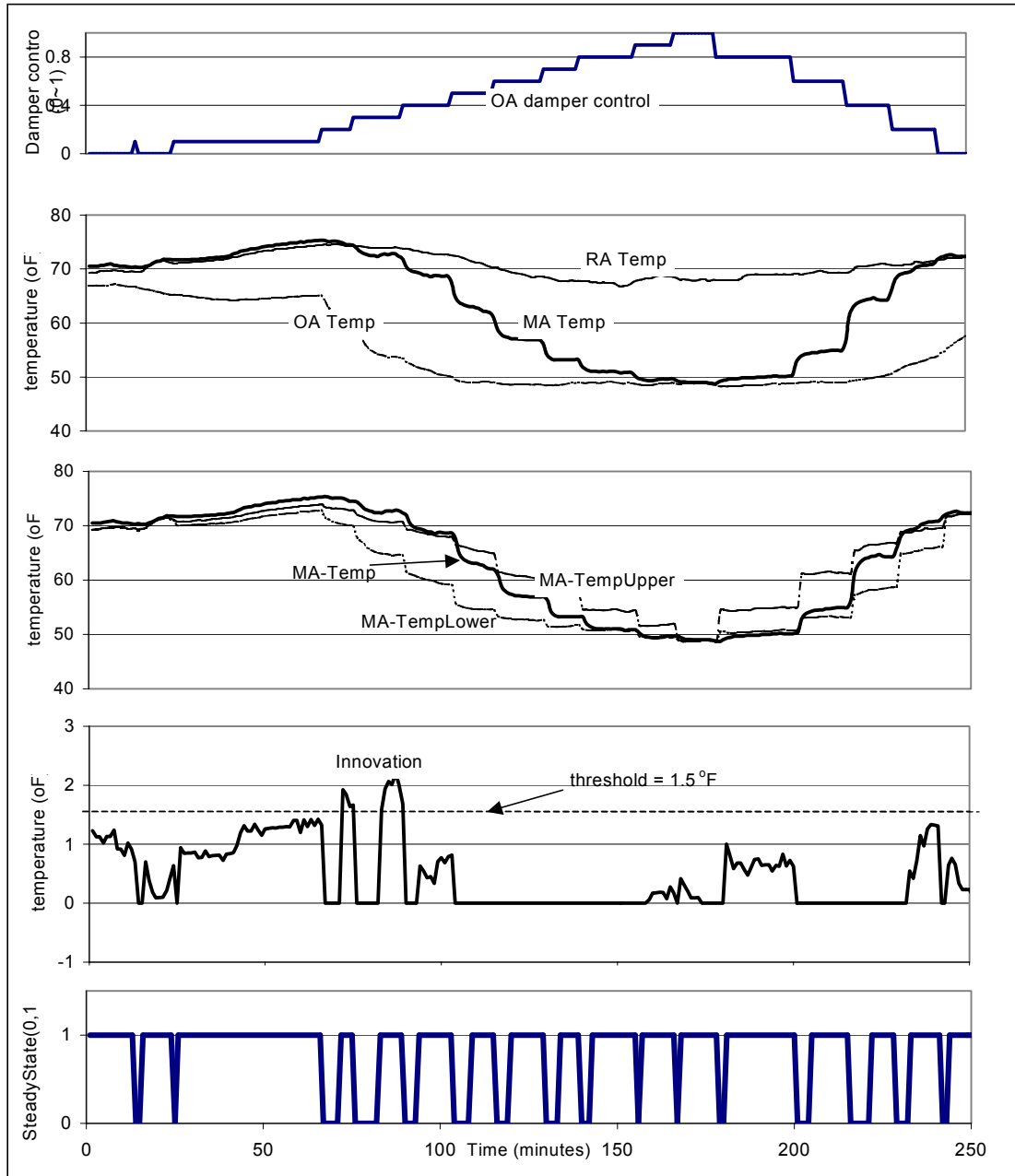

Figure 32: Test results for mixing box with no artificial fault

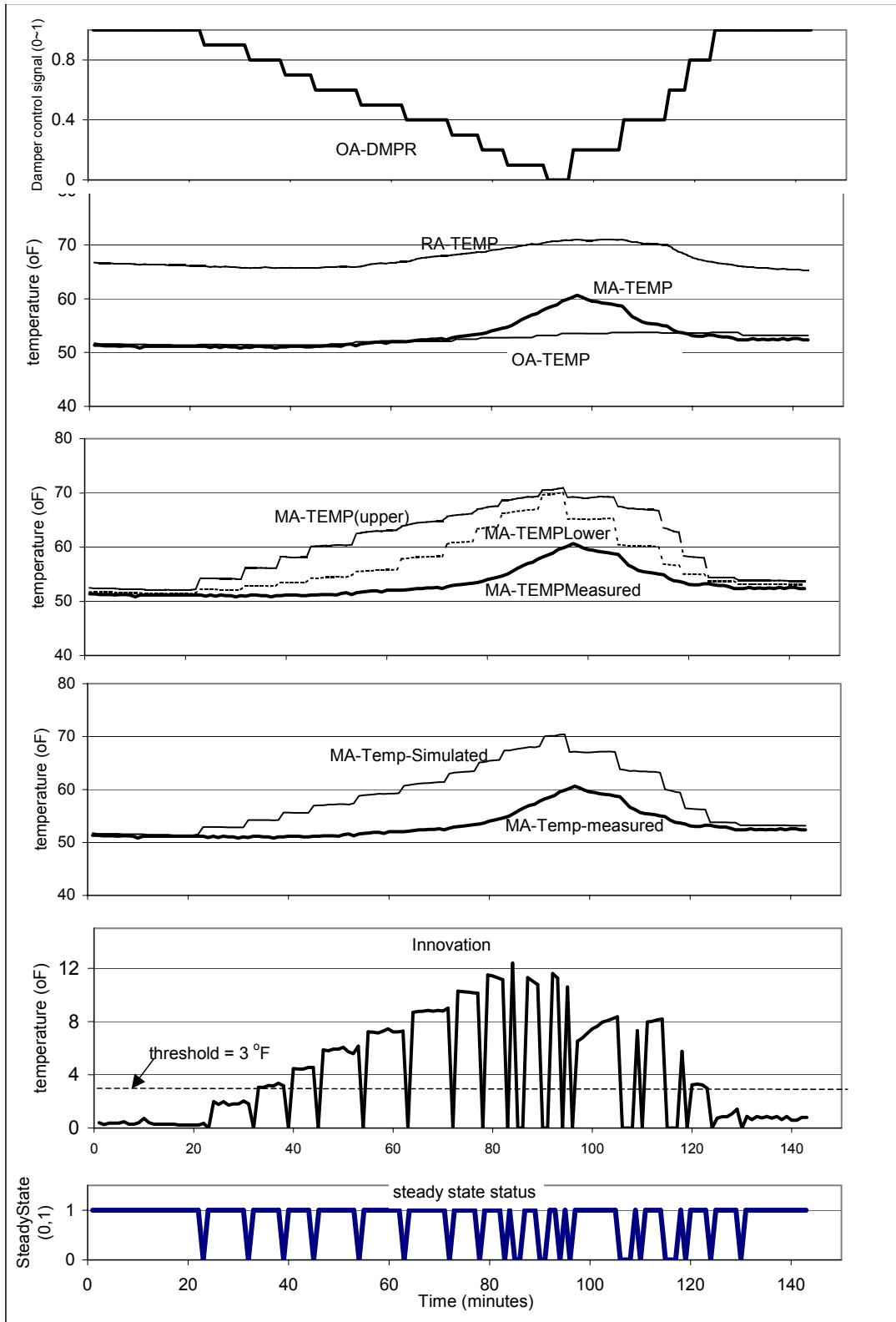

Figure 33: Test results for mixing box with artificial fault

### 6.1.7 DESCRIPTION OF THE MODEL LIBRARY

A library of HVAC component models for use in model-based commissioning has been developed. The model library is web-based to allow for continuous maintenance. Lawrence Berkeley National Laboratory (LBNL) will continue to host and maintain the web-site [http://cbs.lbl.gov/diagnostics/model\\_library](http://cbs.lbl.gov/diagnostics/model_library). These models are freely available; the only restriction is that no-one other than the author may claim ownership or attempt to restrict their use in any way. In addition, no guarantee of the correctness or accuracy of the results obtained by using the models is given by the authors or LBNL. The models are also included on the CD that accompanies this report; however, the models are included on the CD for illustrative purposes and reference should always be made to the web-based version of the library, which will, over time, include both bug fixes and new models.

In general, the models are implemented in one of two formats:

- EES (Engineering Equation Solver), which is an environment that is well suited to prototyping, documenting, demonstrating and exchanging models of single components or simple subsystems /EES 2004/.
- SPARK (Simulation Problem Analysis Research Kernel), an equation-based simulation environment for dynamic and steady state non-linear models of components and systems that is freely available from LBNL /SPARK 2004/.

#### Short Descriptions of the Component Models

Models of the following components or subsystems have been developed and are described briefly below.

Air-to-air plate heat exchanger  
Building zone  
Coil heat recovery loop  
Cooling coil and control valve  
Cooling tower  
Fan (variable speed)  
Fan and Drive Train  
Fan/duct system (VAV)  
Heating coil and control valve  
Heat pipe heat recovery  
Heat pump  
Heat recovery wheel  
Heating coil and control valve  
Humidifier  
Mixing box  
Terminal unit  
Terminal unit control  
VAV terminal units  
Vapour compression chiller  
Mixing box

### **Air-to-air plate heat exchanger**

The model treats the steady-state performance of an air-to-air plate heat exchanger without condensation. The model describes the steady-state part load behaviour using a dimensionless variation of the heat transfer based on nominal conditions. First, the dependence of the convective heat transfer coefficient on the mass flow variation and temperature variation is taken into account. Second, the nominal heat transfer coefficients are calculated based on the nominal boundary conditions (inlet mass flows and temperatures and supply air outlet temperature). The device is modelled as a cross-flow heat exchanger with both streams unmixed.

The following simplifications are made:

- static model,
- no condensation,
- fouling neglected,
- thermal resistance of the heat exchanger material neglected,
- no leakage air flow, and
- no heat loss to the environment.

The algorithm is based on only those data that are known in the design of an HVAC system. No geometrical data for the heat exchanger are required. The model allows different mass flows on each side of the heat exchanger and a variation of the mass flow rate over time. The ratio between the heat transfer coefficients on the two sides of the exchanger can be set as a parameter. The model treats the special case in which both cross sections of the exchanger are identical, in which case the ratio can be calculated as a function of the mass flow and temperature only, and the more general case where the cross sections on both sides are not equal. The model is implemented in EES /Holst 2005/.

### **Building Zone**

The model is based on a very simplified steady state representation of heat and mass transfers and heat and mass balances inside a single zone of a building. The selected output variables are inside air quality (characterized by the concentration of some reference contaminant), air temperature (supposed here to be the same as globe temperature) and humidity. Only two parameters are used to characterise the zone: the envelope heat transfer coefficient and its “equivalent solar aperture”. The model is implemented in EES /Lebrun 2004/.

### **Coil Heat Recovery Loop**

A coil heat recovery loop extracts heat from the exhaust air by means of a cooling coil and supplies the heat to the supply side by means of a heating coil. A lot of systems of this kind do not function as intended after installation. The main reason for this is faulty fluid flow in the loop connecting the cooling and heating coils. Two different models are presented, a model utilizing heat balances is implemented in EES /Eriksson 2004a/ and a model utilizing the NTU method is implemented in IDA /Carling 2004/.

The model implemented in EES /Eriksson 2004c/ uses outdoor air and exhaust air properties to calculate the properties of the air leaving the coils. Additional information needed is the flow in the fluid circuit. The fluid temperatures are calculated by the model. This model does not account for the effect of condensation on the exhaust side. To configure or calibrate the model there is a need to use some kind of parameter estimation procedure. This model is implemented in two EES based tools, one for parameter estimation and one for functional test. The data needed for calibration can either be taken from manufacturer's data or from measurements on the system studied.

Once the model is calibrated it can be used in a number of ways. The model is almost input-output free, which means that it is possible to use data from the measurements available. For example, the model can be used to detect faulty fluid flow and unbalances of the air streams.

The model implemented in IDA is more complex than the EES model. It consists of a number of component models of heating and cooling coils, fluid circuits and supply and exhaust fans, connected to form a heat recovery loop system. Also, this model is used to model a system in which the heat recovery coil on the supply side is used for cooling during warm periods and additional heating during cold periods.

### **Cooling Coil and Control Valve**

Cooling coils typically have four or more rows and are essentially counter flow devices. They may provide dehumidification as well as sensible cooling and the surface in contact with the air may then be partially or completely wet. Cooling coils are controlled by varying the flow rate of water through the coil. Coils in VAV systems also experience variable air flow rate. The challenges in cooling coil modelling are to treat the variation in surface resistance with flow rate and to treat partially wet operation. Two cooling coil models are included in the library:

- A simple model that assumes the coil is either completely dry or completely wet – implemented in EES /Lebrun 2004/
- A detailed model in which the coil is divided into a number of discrete sections along the direction of fluid flow – implemented in SPARK / Xu, P., Kim, M. and Haves, P. 2004a/

Since the water flow rate through a coil is not generally measured in HVAC systems, it is necessary to treat the behaviour of the control valve at intermediate flow rates by modelling its inherent and installed characteristics in order to predict the water flow rate through the coil. The water flow rate is a function of the valve position, the flow rate through the valve when fully open and the leakage. The flow characteristic is assumed to be parabolic, which is an adequate and convenient approximation to the modified equal percentage characteristic used in most control valve intended for this application. Control valve leakage and incorrect sizing are treated by the model. The model is implemented in both the EES and the SPARK models.

Two approaches to the calibration of the coil model from manufacturer's data can be used. If performance data are available at more than one combination of fluid flow rates and/or sensible to latent ratio, these data are used to estimate the values of the coefficients in the air-side and water-side conductance correlations. If only a single rating point is available, it is used to estimate the combined conductance and the separate values of the air-side and water-side conductance coefficients are then estimated using the typical values of the ratios of these coefficients for different types of coil given by /Holmes 1982/.

## Cooling Tower

The cooling tower is modelled as a classical heat exchanger. The model make the approximation that the exiting air is fully saturated, which avoids the need to specify the size of the tower. The inputs to the model are the entering air temperature, relative humidity and flow rate and the entering water temperature and flow rate and the outputs are the discharge air and water temperatures. The model also predicts the fan power, taking into account the air side resistance produced by the water and the fan characteristic. The model is implemented in EES /Lebrun 2004/

## Fan (Variable Speed)

Fans are modelled using variables that have been normalised using the similarity laws: flow, pressure and power factors. These variables are be correlated to each other by polynomial expressions. The model presented here is well fitted to the use of a variable speed fan as flow meter: the flow factor is calculated as function of the (total) pressure factor. The main output of this model is the flow rate expressed here in “specific” value (in kg/s of *dry* air), as usually in air conditioning. Other outputs are: flow rate and pressure factors, exhaust air speed, total pressure difference, isentropic power and isentropic temperature increase across the fan (these two last outputs can be used as checking information). The fan is supposed to be characterised by the diameter of its impeller (scale variable), the exhaust area and the coefficients of the polynomial correlation. Supply air conditions (temperature, pressure and moisture content), rotation speed and *static* pressure difference are taken as input variables. The model is implemented in EES /Lebrun 2004/.

## Fan and Drive Train

A typical fan subsystem in an air-handling unit consists of a fan, a driveline, a motor and a variable frequency drive (VFD). The efficiency of the fan depends on the air flow rate and the rotational speed or the pressure head. The driveline efficiency depends on the drive type and aging condition. The motor efficiency is decided by the electric frequency and the load. The VFD efficiency is a function of load.

The model uses the fan similarity laws to normalise the pressure rise and the flow rate and uses polynomials to represent the normalised head curve and the efficiencies of the fan, drive, motor and VFD. The inputs to the model are air volume flow rate and rotational speed or pressure rise. The outputs are electric power consumption and efficiencies of the fan, drive, motor and VFD. /Wang, F., Yoshida, H. and Miyata, M. 2004a/. The model is implemented in EES /Eriksson 2004b/.

## Fan/Duct System (VAV)

The model treats VAV systems that have fans with variable speed drives. Fan performance is modelled by using the fan similarity laws to normalize the volumetric flow rate, pressure rise and power in terms of the rotation speed. The model assumes that the relationship between fan pressure rise and volumetric flow rate over the limited range of normalized flow used in normal operation can be approximated using a constant term and a squared term. The pressure rise across the fan is balanced by the system pressure drop, which consists of the pressure drop in the other air handling unit (AHU) components and in the distribution system components.

The system resistance upstream of the static pressure sensor is not exactly constant, but varies slightly depending on the relative flow rates in different branches of the duct system; this variation is ignored. The main components of the system resistance are the flow resistances of the coils and sound attenuators, which can be obtained from manufacturers' data. The pressure drop across the filter is assumed to be measured directly. The model predicts the measured static pressure in the duct (or, in the case of the return fan, the pressure in the space) from the fan speed and the air flow rate. When assessing the thermal performance of the mixing box and coils, it is useful to be able to use the measurement of supply air temperature as a proxy for the mixed air temperature or the off-coil air temperature. Depending on the configuration of the air handling unit, this may require correcting for the temperature rise across the fan, which can be estimated from the pressure rise and the efficiency. The model is implemented in SPARK / Xu, P., Kim, M. and Haves, P. 2004a/

### Heat pipe heat recovery

A heat pipe heat exchanger is a fin-tube heat exchanger in which the tubes have enhanced internal heat transfer surfaces and are filled with R-134a. A wall between the air streams prevents mixing. The exhaust air flows through the bottom part of the exchanger and the supply air through the top part. The fluid in the bottom part evaporates and rises to the top where it condenses and the condensate flows downwards.

The process can be described as a coil heat recovery loop in which the heat transfer between fluid and air takes place at constant fluid temperature; sometimes the vapour is superheated and the condensate may be sub-cooled. This heat pipe heat exchanger model implemented in EES /Eriksson 2004d/ is derived from /Faghri 1995/. The model includes a by-pass damper. The model can be used stand-alone to check for leakage in the bay-pass damper and fouling of the coils. Also, the model can be used coupled to other model to simulate the entire air handling unit in detail.

### Heat Pump

Heat pumps (HP) consist of compressors, condensers, evaporators and refrigerant circuits with expansion valves. Low pressure liquid refrigerant enters the evaporator and is evaporated and superheated by the heat energy absorbed from chilled water (heat source) passing through the evaporator shell. Low pressure vapour enters the compressor where pressure and superheat are increased. Heat is given to the hot water (heat sink) by the water cooled condenser. The fully condensed and sub-cooled liquid refrigerant then enters the expansion valve where pressure reduction and further cooling takes place before returning to the evaporator.

An empirical dynamic model from Schwamberger is used to calculate the performance of the heat pump system. All required parameters, such as the coefficients describing the performance, the fluid mass and time constants for the hot and cold loop, etc. are available from manufacturer's data, or can be calculated or estimated using manufacturer's data, respectively.

The model can be used to verify and optimize the operation of the heat pump itself, as well as the operation in combination with related systems such as ground water pump, additional heat exchangers, hydraulic circuits incl. pumps, etc. /Baumann, O. and Kibe, H. 2004b/.

## Heat Recovery Wheel

A heat recovery wheel is an air-to-air heat exchanger and is used to recover either sensible or sensible and latent energy from exhaust air to pre-condition outdoor air. The thermal efficiency of the heat exchanger depends on the material (heat capacity) of the rotor medium, the air flow rate or velocity of the air stream through the rotor (influencing convective transfer), the mass flow ratio of the in- and outgoing air flow, and the speed of the rotor. Rotor speed control is used in order to avoid over-heating or over-cooling under variable outside air conditions.

The model calculates the supply air temperature and humidity, the recovered heat rate (sensible and latent) as well as the temperature and humidity of the exhaust air. The model inputs are the conditions of the return air and the outside air (temperature and humidity) as well as the flow rates for both air streams and the speed of the rotor. Manufacturers' data for several sizes of rototherm<sup>®</sup> heat recovery wheels are already implemented in the model. Any rotary heat exchanger can be implemented using manufacturers' data describing the performance of the device depending on (i) the air flow rate (air velocity), (ii) the ratio of in and out flowing air, and (iii) the rotor speed.

Additionally to inappropriate functionality of the rotary heat exchanger, the performance can be impaired by fouling and leakage. Leakage occurs by two mechanisms: carry-over and seal leakage and is influenced by the position of the supply and exhaust fan. /Baumann, O. and Kibe, H. 2004a/. The model is implemented in EES.

## Heating Coil and Control Valve

The heating coil model is an effectiveness-NTU model in which the overall conductance depends on the fluid velocities. In a one row coil, the air-side is unmixed and the water side is mixed. A heating coil with two or more rows may be considered to be counterflow; the error is small since the effectiveness of heating coils is generally small. The control valve model for a flow control coil is the same as that used with the cooling coil models. The parameters are estimated in the same way as for the cooling coil. The model is a slight variant of the model described by Lebrun /2004/. This model is implemented in EES and SPARK.

## Humidifier

The model treats liquid humidifiers in which liquid water is evaporated into the air stream (as opposed to injecting steam). The humidifier is modelled as a semi-isothermal heat exchanger. The inputs are the air and water inlet conditions and flow rates and the outputs include the outlet state of the air and the effectiveness. This model is implemented in EES /Lebrun 2004/.

## Mixing box

Prediction of the mixed air temperature and humidity in an air handling unit involves estimating the outside and return air fractions and then performing heat and moisture balances on the mixed air stream. Prediction of the air-flow fractions from first principles is impractical because (i) the return air and mixing plenum pressures change with fan speed and (ii) it is difficult to estimate air-flow resistances in mixing boxes. This said, the behaviour in the middle of the operating range is relatively unimportant compared to the behaviour at each end of the operating range. An empirical approach to modelling the airflow fractions has therefore been adopted.



At the commissioning stage, when only design information is available, the model describes the range of acceptable behaviour. A 3:1 gain variation is used by default; when the damper position is 50%, the permitted upper limit of the outside air fraction is 75% and the lower limit is 25%. The maximum acceptable deviations from 0 and 100 % outside air fraction at each end of the operating range, which are determined by the leakage in the dampers, should be specified by the designer, based on the performance required and manufacturer's data. Note that leakage can arise from imperfections in the dampers themselves, from incorrect installation in the duct or from a mismatch between the ranges of operation of the damper and its actuator. Once the mixing box has been commissioned, the results of the functional test can be used to fit a polynomial to the measured variation of the outside air fraction with the control signal to the damper actuator. The model is implemented in SPARK / Xu, P., Kim, M. and Haves, P. 2004a/.

### **Terminal Unit**

Terminal units such as fan-coils are treated as semi-isothermal heat exchangers (the isothermal "fluid" is the indoor environment). The two outputs selected here are the heating (or cooling) power provided inside the zone and the fluid temperature at the exhaust of the unit. In the simplest approach, the unit is supposed to be fully characterised by only one parameter: its heat transfer coefficient. Three input variables have to be supplied to this model: the fluid flow rate, its supply temperature and the zone (air or globe) temperature. The model is implemented in EES /Lebrun 2004/.

### **Terminal Unit Control**

The model represents the behaviour of a proportional control system with a valve installed in the circuit supplying the terminal unit. The hydraulic resistance of the circuit (without the valve, but with the terminal unit) is taken into account in order to give a realistic valve "authority". The two outputs of this model are the valve position and the corresponding flow rate. The two parameters are the maximum valve (fictitious) aperture and the circuit (fictitious) aperture. The inputs are the temperature set-point, the actual temperature detected by the control sensor, the pressure difference applied to the circuit and the proportional control gain. The model is implemented in EES /Lebrun 2004/.

### **VAV Terminal Units**

The model detects faults by applying a statistical method to four values calculated using the room air temperatures and the demand control signal of VAV damper opening of each unit at steady state. The inputs to the model are zone air temperature, temperature set point, the demanded position of the VAV damper and the significance level for the statistical method. The output are Fault Detection and Diagnosis (FDD) results. /Miyata, M., Yoshida, H., Asada, M., Wang, F. and Hashiguchi, S. 2004/. The model is implemented in Matlab.

### **Vapour Compression Chiller**

The chiller model consists of first principles sub-models of the compressor, condenser and evaporator. The chiller is supposed to use one (or several) rotary compressor(s), with constant internal volume ratio and with continuous capacity control. It is also supposed to have an air-cooled condenser, with continuous control of fan speed and a water (or brine) heated evaporator. The model is implemented in EES /Lebrun 2004/.

### 6.1.8 VERIFICATION OF MODEL PERFORMANCE USING REAL BUILDING DATA

A number of the models in the library have been verified off-line by configuring them with manufacturer's data and comparing their predictions to field measurements. Verification of the AHU component and subsystem models developed by LBNL is described in /Xu et al. 2004b/.

A statistical model of multiple VAV boxes has been verified using the operational data collected from VAV systems in a real office building in Tokyo. Performance was verified on 150 VAV terminal units in 10 AHU systems, which are not equipped with airflow rate sensors. The FDD method was able to reduce the number of suspected faulty units from 150 (100%) to 18 (12%), with all the 6 units that truly have faults falling in the group of 18 suspected faulty units. This result shows that this model can reduce the required time and manpower or cost for commissioning by about 90% compared with those needed by the present manual check, which is generally done by checking all the units one by one. /Miyata, M., Wang, F. and Yoshida, H. 2003/. Further model verification has been done on the rotary heat exchanger model /Baumann, O. and Kibe, H. 2004a/ and the heat pump model /Baumann, O. and Kibe, H. 2004b/.

### 6.1.9 REFERENCES

Baumann O. and Kibe H., Functional Performance Test of a Rotary Heat Exchanger using Models. Submitted to Annex 40 – M8, Ebert-Ingenieure, München, Germany, 2004a.

Baumann O. and Kibe H., Functional Performance Test of a Heat Pump System using Models. Submitted to Annex 40 – M8, Ebert-Ingenieure München, Germany, 2004b.

Carling P. and Isakson P., Model-Based Functional Performance Testing of AHU in Kista Entré. Proceedings of International Conference on Enhanced Building Operation, Paper no 60, ICEBO, Paris, 2004.

Cui J. and Wang S., Health Monitoring and Continuous Commissioning of Centrifugal Chiller Systems. Proceedings of International Conference on Enhanced Building Operation, Paper n°38, ICEBO, Paris, 2004.

EES, Engineering Equation Solver. F-Chart Software. <http://www.fchart.com/ees/ees.shtml>, 2004.

Erikson J., Using product specific Simulation Models in a Tool for Manual Commissioning of Air Handling Units. Proceedings of International Conference on Enhanced Building Operation, ICEBO, 2003.

Erikson J., Practical Experiences from the Use of a Method for Active Functional Tests and Optimization of Coil Energy Recovery Loop Systems in AHUs. Proceedings of International Conference on Enhanced Building Operation, Paper no 15, ICEBO, Paris, 2004a.

Erikson J., Fan Model Description. Submitted to Annex 40 – M8, 2004b.

Erikson J., Coil Energy Recovery Loop Model Description. Submitted to Annex 40 – M8, 2004c.

Erikson J., Heatpipe Model Description. Submitted to Annex 40 – M8, 2004d.

Faghri A., Heat pipe science and technology, Taylor and Francis, 1995.

Georges B. and Lebrun J., Model-assisted Commissioning of a Chilling Plant. Proceedings of International Conference on Enhanced Building Operation, Paper no 102, ICEBO, Paris, 2004.

Holmes M.J., The simulation of heating and cooling coils for performance analysis. Proceedings of System Simulation in Buildings'82, Liège, Belgium, 1982.

Holst J., Air-to-Air Plate Heat Exchanger. Annex 40 documentation. 2005.

Lebrun J., Simulation Models Usable for Commissioning. Submitted to Annex 40 – M8, 2004.

Matlab. The MathWorks. <http://www.mathworks.com>

Miyata M., Wang F. and Yoshida H., Experimental Study on Model-based Commissioning Method of VAV Systems in a Real Building. Proceedings of International Conference on Enhanced Building Operation, ICEBO, 2003.

Miyata M., Yoshida H., Asada M., Wang F. and Hashiguchi S., Fault Detection and Diagnosis Method for VAV Terminal Units. Proceedings of International Conference on Enhanced Building Operation, Paper no 52, ICEBO, Paris, 2004.

Miyata M., Yoshida, H., Asada M. and Wang F., FDD Model for Multiple VAV Terminal Units. Submitted to Annex 40 – M7, 2004 a.

Miyata M., Yoshida H., Asada M. and Wang F., VAV Box Controller Model. Submitted to Annex 40 – M7, 2004b.

Mundt B., Some Measurement Problems in Heat Recovery Systems. Tekniskt Meddelande N°296, Uppvärmnings och Ventilationsteknik KTH, Royal Institute of Technology, Sweden,, Vol. 16, Page 89-96,1986.

Odajima T., Takashi M. and Juckel-Murakami B., Model-based Commissioning Methodology for Simple Duct Systems. Proceedings of International Conference on Enhanced Building Operation, Paper no 53, ICEBO, Paris, 2004.

Odajama T., Model-based Commissioning Methodology for Simple Duct System. Submitted to Annex 40 – M7, 2004.

SPARK, Simulation Problem Analyses and Research Kernel. Lawrence Berkeley National Laboratory and Ayres Sowell Associates, Inc. Berkeley, CA.: Lawrence Berkeley National Laboratory. <http://simulationresearch.lbl.gov>, 2004.

Wang F., Yoshida H. and Miyata M., Total Energy Consumption Model of Fan Subsystem suitable for Continuous Commissioning. ASHRAE Transactions, Volume 110, Part 1. 2004a

Wang F., Yoshida H. and Miyata M., Model-based Fan Subsystem Automated Commissioning. Submitted to Annex 40 – M7, 2004b.

Wang F., Yoshida H., Kitagawa H., Matsumoto K. and Goto K., 2004. Model-based Commissioning for Filters in Room Air-Conditioners. Proceedings of International Conference on Enhanced Building Operation, Paper no 55, ICEBO, Paris, 2004.

Wang F., Yoshida H. and Kitagawa H., Model-based Air-conditioner Filter Automated Commissioning. Submitted to Annex 40 – M7, 2004.

Xu P., Kim, M. and Haves P., Software toolbox for component-level model-based fault detection methods. Report to California Energy Commission. Berkeley, CA., Lawrence Berkeley National Laboratory, 2004a.

Xu P., Kim M. and Haves,P., Tests of component-level model-based fault detection methods using field data. Report to California Energy Commission. Berkeley, CA., Lawrence Berkeley National Laboratory, 2004b.

Xu P., Haves P. and Kim M., Model-Based Automated Functional Testing - Methodology and Application to Air Handling Units, ASHRAE Trans, 111, Pt 1, 2005.

Yamaha M. and Takahashi M., An Analysis Method for Operations of Hot Water Heaters by Artificial Neural Networks. Proceedings of International Conference on Enhanced Building Operation , Paper n° 66, ICEBO, Paris, 2004.

## 6.2 USING SIMULATION MODELS AT THE BUILDING LEVEL

### 6.2.1 BACKGROUND

Whole-building models are routinely used in the design of building HVAC systems but are not widely used for commissioning. Various models or simulations are sometimes used during the pre-design phase. These models generally simplify the input process with numerous default inputs to speed their use to enable rapid feedback on the significance of major envelope or system configuration options early in the design process. More detailed models are customarily used to size the heating and cooling equipment during the design phase, and a detailed simulation model such as DOE-2, TRNSYS, EnergyPlus, IDA, RIUSKA, etc. may be used to explore the implications of a limited number of design options on annual energy use. While the continuous use of simulation throughout the life cycle of a building has been contemplated for the last two decades (e.g. Selkowitz, et al., 1990), at least, it has never yet been employed, but progress in linking simulation programs to CAD programs (e.g. IDA, 2002) seems likely to change this in the future. A calculation of annual heating use is now being required in the European Union for all new buildings as part of the Energy Performance of Buildings Directive (European Parliament, 2002). This directive also requires all existing buildings to eventually have a specified type of energy use calculation. This will clearly increase the use of energy simulation.

When the Annex began, simulation had rarely been used as part of the commissioning process. It had apparently been used only for isolated retrocommissioning projects (e.g. Liu and Claridge 1995, Liu et al. 1999). Simulation is also sometimes used during the design process in a way that may be viewed as part of “commissioning” the design. However, participants believe there are significant other opportunities to utilize simulations to improve the commissioning process. This is particularly true when simulation models have already been used as part of the design process, as part of a savings determination process (e.g. Option D of the *International Performance Measurement and Verification Protocol* (IPMVP, 2001) or for diagnostics in the building.

### 6.2.2 IMPORTANT FACTORS IN WHOLE BUILDING SIMULATION FOR COMMISSIONING

Use of whole building simulation in commissioning is likely to be most practical in cases where a simulation has already been performed as part of the design process or as part of a retrofit evaluation. The input parameters for the design simulation are a direct expression of the design intent. The simulation can then be used to predict building performance and deviations would indicate the need for commissioning measures to bring the building to design intent. However, the specific comparisons that can be performed will be dictated in part by the capabilities of the simulation model and in part by the performance data available for comparison with the simulation. In most cases, data from a building automation system (BAS) will be used for comparison with the simulation, necessitating appropriate energy consumption sensors on the BAS. The number of building parameters required for an adequate simulation will vary depending on the building type, location, and use. Some of these issues are discussed in Haves et al. (2001).

The simulation will generally be used to evaluate what we will term “passive testing” or “active testing”. The term passive testing will refer to use of data collected during normal operation of the building, without any intervention to extend the range of operating variables implemented during any particular time interval. In contrast, active testing will entail use of specified control sequences to determine response to an extended range of operating variables, or a particular dynamic sequence of operating variables.

### ***Passive testing***

The passive tests described here are simply illustrative of tests that may be developed and implemented, and do not represent tested diagnostic procedures. Many others will undoubtedly be developed and used.

- a. Check room temperatures and humidity levels. Trend logs of the temperature and humidity in every zone can be tracked over one or more days. As long as these values stay within the set points (and any control undershoot, overshoot or throttling range), temperature and humidity control are acceptable for the occupancy and ambient conditions during the test. If not, diagnostics (that may or may not involve simulation) are needed to diagnose reasons for the excursions observed.

If this test is passed,

- b. Compare energy use with predictions over a period of at least a few days. If measured consumption is within an acceptable range of predicted consumption, this test is passed for the occupancy and ambient conditions during the test. However, it is non-trivial to develop practical “pass” criteria for this type of test. If “pass” criteria are narrowly exceeded, this may indicate a need to change some simulation inputs and continue the test over a longer period.
- c. Extrapolate performance from limited trend data to design conditions. It is necessary to determine whether equipment capacity and other parameters are adequate to provide comfort at design conditions.

Depending on the capability of the simulation and the sensors available on the BEMS, it is desirable to verify a wide range of operating parameters such as airflows and supply temperatures to individual zones, waterside system parameters, and primary system performance.

### ***Active Testing***

Active testing involves specific active tests implemented for diagnostic purposes; these may be triggered in response to failure of one or more passive tests. It may also involve functional tests devised to explore the comfort control capabilities of the system and its dynamic response over a wide range of operating conditions. Active tests will normally provide some empirically determined variables to be used as input parameters in the simulation program being used.

Active testing will typically vary an input variable with a major impact on building comfort and energy performance. It may include the cycling of a known lighting load or other major load on/off on a specific cycle devised to test response of the HVAC system and test system performance. Likewise, it may involve variation of space temperature set points in a way that will test system capacity and control.

A number of tests are needed to test system response to a range of loads in the spaces and to determine the efficiency with which the primary and secondary systems are working with the control system to meet the space loads.

### ***Additional Active/Passive Testing Issues***

While simulation has been used in a number of specific commissioning applications reported in this chapter, a wide range of questions remain to be addressed more generally by both active tests and passive testing techniques. General questions raised by Annex participants but not specifically addressed or answered include:

- What capabilities are required in a simulation model to be used for commissioning in specific types of applications?
- How do the necessary simulation capabilities depend on the building type and system type?
- Should tests be devised for a specific model or a group of models?
- Should a model be designed specifically to handle a necessary test suite?
- How should energy balance be used with simulation in the commissioning process?
- To what degree should experimental results be used to tune inputs to the model, or how many simulation inputs should be measured?
- How much time will be required for simulation using a specific simulation tool?
- How much time can be spent for simulation in a specific case?

Other specific questions that need to be addressed in the future include:

- How can the capability of the equipment to meet peak loads be most easily determined?
- What about equipment oversizing? Undersizing?
- How can the efficiency of the equipment to meet building needs under normal operating conditions best be determined?
- User behavior impacts performance – particularly in terms of windows, lights and thermostat settings – what are the key parameters that will characterize this behavior?
- The envelope performance is generally more important in Europe and Asia than in most buildings in North America since envelope gains/losses are generally larger relative to internal gains. What are the most important envelope characteristics for commissioning? E.g. what is the importance of different building shapes vs. W/K/m<sup>2</sup>-floor area, or window area/m<sup>2</sup> floor, the use of operable windows, window tightness, etc.



### 6.2.3 DIFFERENT APPLICATIONS OF BUILDING-LEVEL MODELS FOR COMMISSIONING

Annex participants have identified and defined six different applications of whole building models for use in different types of commissioning. These are:

1. Use During the Design Process. Models may be used during the pre-design phase early in the design process – to assist in “commissioning” the design. Typically, models configured for rapid use, such as TRNSYS Light, Enerwin, etc. will be used for this purpose. They may or may not be used for energy simulation. These models are not used during the commissioning after construction. The use of detailed simulation models during the design phase may also be considered to be part of “commissioning” the design.
2. Use in Post-Construction Commissioning of New Buildings. A design simulation of the building may be used to predict heating and cooling performance and the predictions may be compared with measured use – significant deviations then serve as clues to identify problems in the building. The design simulation should have the occupancy schedules changed, if necessary to reflect the actual occupancy of the building. Simulation may also be used after the building is occupied to refine and optimise controls strategy, if actual occupancy and use differs significantly from the design assumptions. Relatively complex simulations will be used for this purpose.
3. Use of a Design Simulation for On-Going Commissioning. The same simulation developed in the design process may then be run at specified intervals, e.g. weekly, monthly, etc. and the model predictions compared with the measured energy consumption. Deviations may serve to trigger an alarm when building performance degrades. Diagnostics for the probable causes of such deviations need to be developed. These simulations will probably be run off-line, but may be run on-line if the control system can accommodate the simulation.
4. Use of Calibrated Simulation for Retro Commissioning. A rapidly calibrated simulation may be used as a diagnostic aid and to predict the savings that will be achieved from implementing proposed commissioning measures. Several references to calibration procedures are given in Claridge et al. (2004) which also describes a procedure for rapid calibration of simulations.
5. Use of Calibrated Simulation for On-Going Commissioning. The calibrated simulation developed in the retro-Commissioning process may then be run at specified intervals, e.g. daily, weekly, monthly, etc. and the model predictions compared with the measured energy consumption. Deviations may serve to trigger an alarm when building performance degrades. Diagnostics for the probable causes of such deviations need to be developed. These simulations may be run off-line or on-line if the control system can accommodate the simulation.
6. Use of Simulation to Evaluate New Control Code. Either the design simulation or a calibrated simulation may be used to test the energy impact of proposed changes in control code before implementation. It is expected that this will generally be done off-line. In principle, this could be done without using whole building simulation. It is assumed here that if a whole building simulation is being used for on-going commissioning of the building, it will be desirable to use



this simulation to evaluate control options before implementation, provided the simulation being used is capable of simulating the control sequence being considered.

#### 6.2.4 EXAMPLES OF USE OF SIMULATION MODELS AT THE BUILDING LEVEL

Each different application of whole building models in commissioning will be described in this section in the context of one or more specific applications. Additional detail is available in papers included on the CD.

##### *Use During the Design Process*

Holst (2003) used simulation in conjunction with the generic optimization program GenOpt (Wetter 2001) to develop an optimized set of design parameters for a 461-m<sup>2</sup> school building in Trondheim, Norway. The optimization program was used to select parameter variations on 14 input variables used in the simulation program EnergyPlus (LBL 2001). The following quantities were optimized: window area and U-value for each of the four sides of the building; thermal mass, exterior wall insulation thickness, roof insulation thickness, floor insulation thickness, shading device transmission, and the night setback temperature. Each parameter was assigned a starting value corresponding to the value used in the school as built. GenOpt then determined the minimum combined heating, cooling and lighting consumption for the building by varying these parameters within set bounds using specified step values for each parameter. The optimization process reduced the simulated consumption of the building by 22.5% after performing 122 simulations from the  $2.9 \times 10^{10}$  combinations permitted by the input variables. The parameter variation used for nine of the 14 parameters varied is shown in Figure 34.

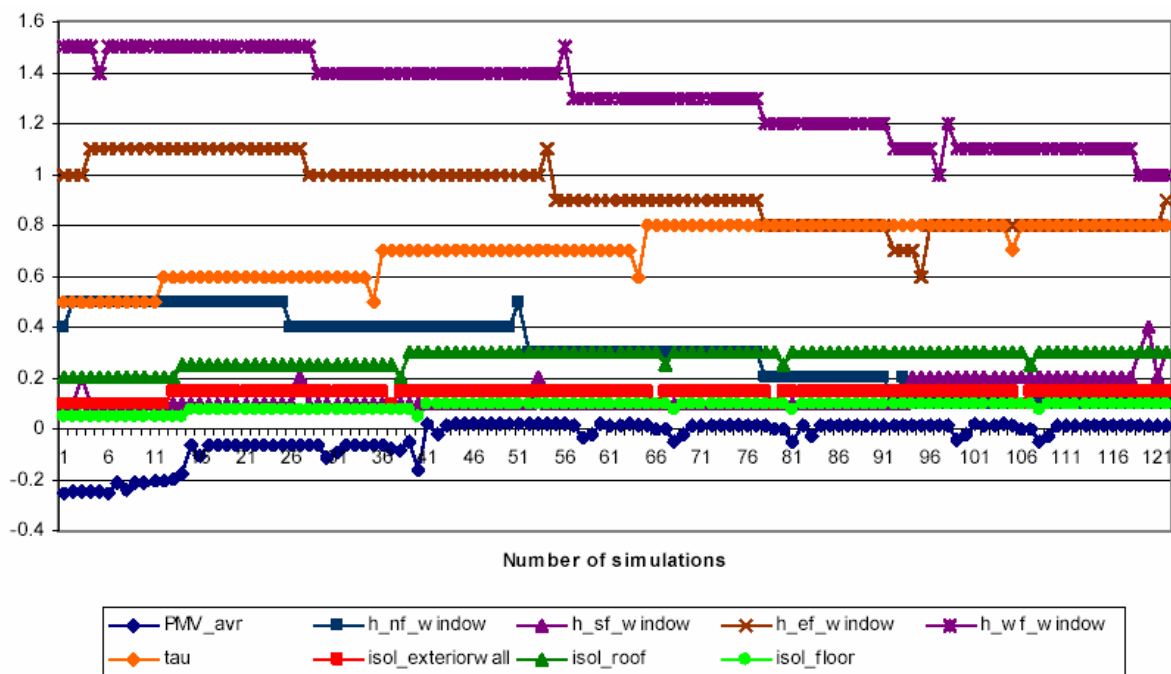

Figure 34: Variation of nine of the design parameters optimized by Holst (2003). Note that several of the parameters are scaled to fit the diagram and hence the y-axis has no units.

### Use in Post-Construction Commissioning of New Buildings

Keranen and Kalema (2003 and 2004a, 2004b) have utilized simulations of the 9500 m<sup>2</sup> IT-Dynamo Building in the commissioning process. This building, which houses the Department of Information Technology at Jyväskylä Polytechnic in Jyväskylä, Finland, was completed in May 2003 and placed in service in August 2003. The building has been simulated using the programs IDA-ICE (IDA 2002) and RIUSKA (RIUSKA 2003) based on DOE-2. The heating and electricity use of the building are monitored and the electricity used for HVAC is separately monitored.

Indoor conditions including numerous temperatures and CO<sub>2</sub> levels are monitored and stored for two days on the building automation system. During commissioning, these variables have been transferred to memory for longer terms.

Comparison of the simulated and measured heating consumption showed measured heating consumption about 35% higher than the simulated consumption during the first nine months of operation as shown in Figure 35. Investigation revealed that heating and cooling deadbands were too small in about 20% of the building area, resulting in continuous operation of either the heating or the cooling at maximum values in these areas. The major problem seems to be that the rotating wheel heat recovery system is not performing as designed, with supply air up to 4°C lower in temperature than expected after passing through heat recovery. This is caused by problems controlling the temperature of return liquid in the heating and cooling system.

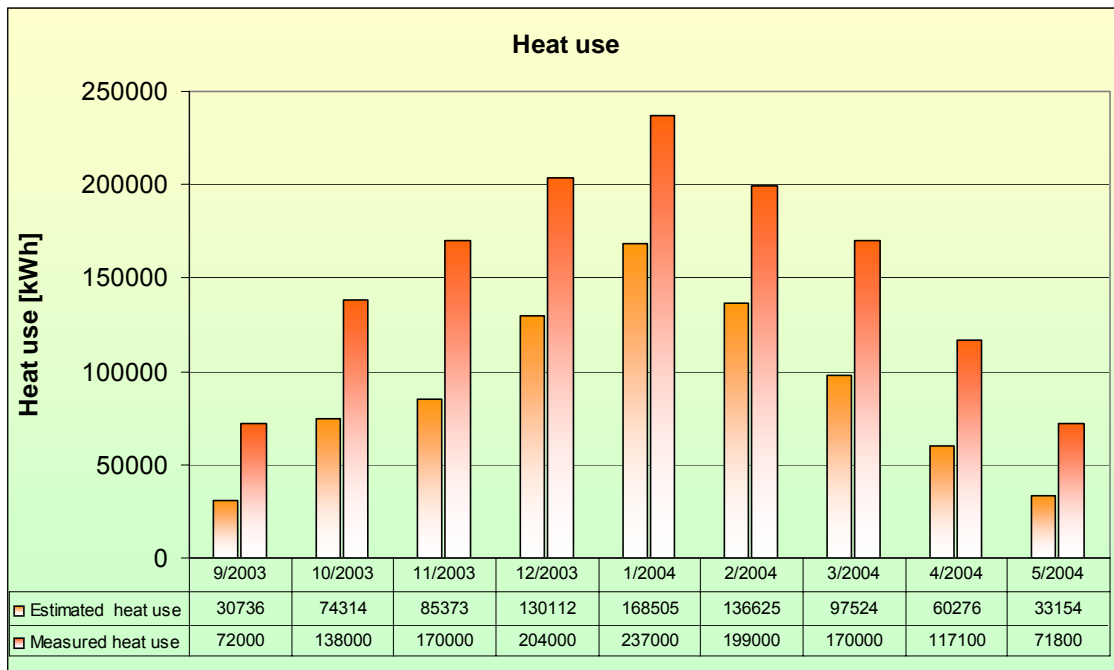

**Figure 35: Simulated (on left) and measured space heating consumption in the IT-Dynamo Building from September 2003 – May 2004 (from Keranen and Kalema 2004).**

Comparisons between measured and simulated electricity consumption show that total building electricity consumption has been at least 10% higher than expected. On-going work has found that this discrepancy is entirely within the HVAC systems with HVAC electric consumption 35% higher than expected. The reason for high electricity use of the HVAC-system appears to be in the electricity use of fans and pumps.

Carling et al. (2003a, 2003b, 2004) have tested the use of whole building simulation in the commissioning of an office building in Katsan, Sweden. This building utilizes rather innovative HVAC systems. They used the IDA simulation environment to assess these untested HVAC-solutions and for dimensioning. During the initial commissioning they evaluated the performance using extensive measurements from the BEMS. Five-minute values for about 200 signals were collected during a full year following the initial occupancy of the tenants. A detailed whole-building simulation model was calibrated with adjusted internal loads based on measured electrical power and measured weather inputs. To determine whether the HVAC-systems performed as intended, the results of the calibrated model were compared with measurements of the whole-building energy use as well as with several important temperatures and control signals.

Comparison between the extensive measurements and the calibrated model were made and use of the different residuals for evaluation of the HVAC-system performance and on-going commissioning are presented. At least five problems with control set point and/or operation were detected and corrected as a result of this process.

Carling and Isakson (2004) found the cost of the procedure to be too high for routine application for the following reasons: generating the detailed model took several weeks; model run times were long; additional sensors (at additional cost) would have improved model contribution to commissioning; and dealing with poor data is time consuming. They conclude that the approach has a large potential to support better design and commissioning of buildings provided that the costs can be decreased to an acceptable level.

Niwa et al. (2004) have examined the performance of five simulation programs (HASP/ACSS, EnergyPlus, BOE-2, Dest and HVACSIM+) for use in post-construction commissioning as well as design commissioning and on-going commissioning. Despite extensive efforts to accurately simulate the same building using all five programs, the highest annual cooling load was 1.77 times the lowest (310 MWh vs. 175 MWh). This work did not compare the programs using methods such as BESTEST (IEA 1995, ANSI/ASHRAE 2001). Figure 36 shows the maximum heat extraction rate simulated by each program for heating and cooling as well as the actual rate. It also shows the annual values of the heating and cooling extraction simulated by each program. The cooling values from the different programs agreed within about 25%, but the heating values showed variation of more than a factor of two. This suggests that great care will be necessary to ensure that a program used for commissioning can adequately simulate a building and that it is properly used.

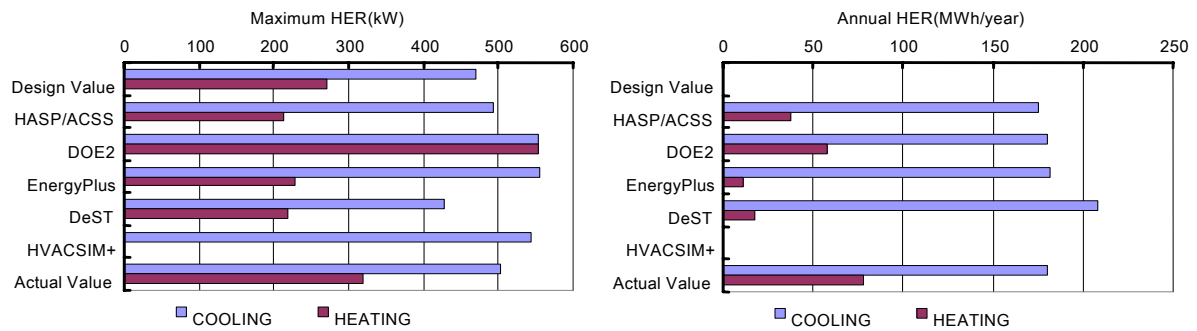

**Figure 36: Comparison of heating and cooling HER (Heat Extraction Rates) (from Niwa et al. 2004).**

### ***Use of a Design Simulation for On-Going Commissioning***

Adam et al. (2004) simulated a large 25 000 m<sup>2</sup> office building using TRNSYS with the intent of using the simulation in on-going commissioning. The model (TRNSYS Type 56) was calibrated against measurements from typical winter and summer periods (two months each) and allowed to extrapolate the heating and cooling loads to the whole year. Calibration mainly modified the occupation and system operation schedules to achieve reasonably accurate results regarding the heating load while numerous operation faults make the cooling load of the building unrealistic. Consequently, the calibrated model has not been used yet in the on-going commissioning process.

### ***Use of Calibrated Simulation for Retro-Commissioning***

Simulation at the building level may be used as a tool in conjunction with data on the demands and needs of the building, and an energy balance to determine the potential for energy savings in the building. This latter application is particularly apt when commissioning an older building. For older buildings, utility billing history is generally available. The increasing use of interval electricity metering means that hourly or 15-minute data is increasingly available at the whole building level. The decreasing cost of metering and recording such data means that it will also increasingly be available on the BEMS for additional end uses such as heating and cooling, though this is not yet common.

Such data can be used to calibrate a simulation program to the measured consumption data from the building. When this is done, the simulation can readily be used to accurately explore the impact of a wide range of building changes, ranging from operational changes that may be implemented as part of a commissioning program to evaluation of thorough energy efficiency retrofit measures, and demand reduction measures. The simulation can also be used to investigate the comfort impact of certain measures before they are implemented.

Claridge et al. (2004) have developed an approach to calibration of a cooling and heating energy simulation for a building to measured heating and cooling consumption data that addresses some of the time/cost constraints reported by Carling and Isakson (2004). This approach is suitable for buildings where internal gains are generally significantly larger than envelope gains/losses. They present a methodology for the rapid calibration of cooling and heating energy consumption simulations for commercial buildings based on the use of “calibration signatures”, that characterize the difference between measured and simulated performance. The method is described and its use is demonstrated in two illustrative examples and two case studies. The report contains characteristic calibration signatures suitable for use in calibrating energy simulations of large buildings with four different system types: single-duct variable-volume, single-duct constant-volume, dual-duct variable-volume and dual-duct constant-volume. Separate sets of calibration signatures are presented for each system type for the climates typified by Pasadena, Sacramento and Oakland, California.

Liu et al (2002) primarily addresses the use of simulation for on-going commissioning, but also contains two case studies in which the AirModel simulation (Liu, 1997) was used to identify and diagnose system problems at the whole building level. These cases studies illustrate the value of calibrated whole building simulation for retro commissioning. The first case study conducted a calibrated simulation of a 28,000 m<sup>2</sup> hospital in Galveston, Texas as part of a retro commissioning project. The calibration process lead to identification of 2°C – 4°C differences between pre-cooling, cold deck and hot deck temperatures and set points. The simulation was subsequently used to develop optimum schedules for these quantities. In the second case study, simulation was performed on an 11,400 m<sup>2</sup> medical laboratory building in Houston, Texas. The calibration process indicated a probable error in the chilled water metering and serious lack of control in the chilled water valves. Subsequent field inspections revealed that the chilled water meter was reading only 50% of the correct consumption due to an open bypass valve and found that leaks in the pneumatic control lines had caused the chilled water valves to operate in the full open position much of the time.

The simulation effectively identified HVAC component problems and was used to develop improved or “optimized” HVAC operation and control schedules. The simulation indicated that building thermal energy consumption would be reduced by 23%, or \$191,200/yr by using the optimized operating schedules in the building. The measured energy savings were consistent with the simulated savings.

Andre et al. in “Re-Commissioning of the CAMET HVAC System: A Successful Case Study?” (2003a) and in “Re-Commissioning of a VAV Air-Distribution System,” (2003b) describe the retro commissioning of a relatively new building. The use of building level simulation in this project is described in Adam et al. (2004).

### Use of Calibrated Simulation for On-Going Commissioning

A simulation calibrated to a building after commissioning is performed may be used to check the measured consumption on an on-going basis. Significant increases can then serve as an alarm to indicate when additional commissioning followup is justified. Comparison once a month or once a quarter may be adequate. Building operators generally don't get very interested in following up on an alarm that does not directly impact comfort and create occupant complaints unless it has a rather substantial cost impact. Hence, there is little need for this information on an hourly or even a daily basis when tracking whole building consumption. However, indication of some problems such as lights or equipment that is left on over nights or weekends is clearly desirable as soon as it is observed. Observed discrepancies need to be filtered to minimize false alarms. Experience with building consumption fluctuations suggests that the minimum setting for an alarm based strictly on increased consumption should be an increase of 5-10% in heating or cooling consumption over a period of a month or more. This type of tracking may be performed with simple regression or neural network models of consumption, as well as with more detailed physical models. If the simulation is coupled to a diagnostic system that can indicate probable causes of deviations, this will increase its value.

The need for this type of tracking has been explored by Turner et al. (2001), and findings in two specific buildings have been investigated and reported by Claridge et al. (2002), Chen et al. (2002), and Liu et al. (2002). In both of these cases, component failures in the buildings that did not result in comfort problems resulted in major increases in energy use (~\$75,000/year). Figure 37 shows daily values of chilled water consumption (in kBtu/hr) in one of these buildings as a function of ambient temperature. The top solid line is a regression line through consumption values measured before retro commissioning, the bottom line represents consumption following retro commissioning, the open squares (red) show consumption after the component failure(s), and the solid triangles (blue) show consumption after the component failures were detected by on-going commissioning procedures and corrected.

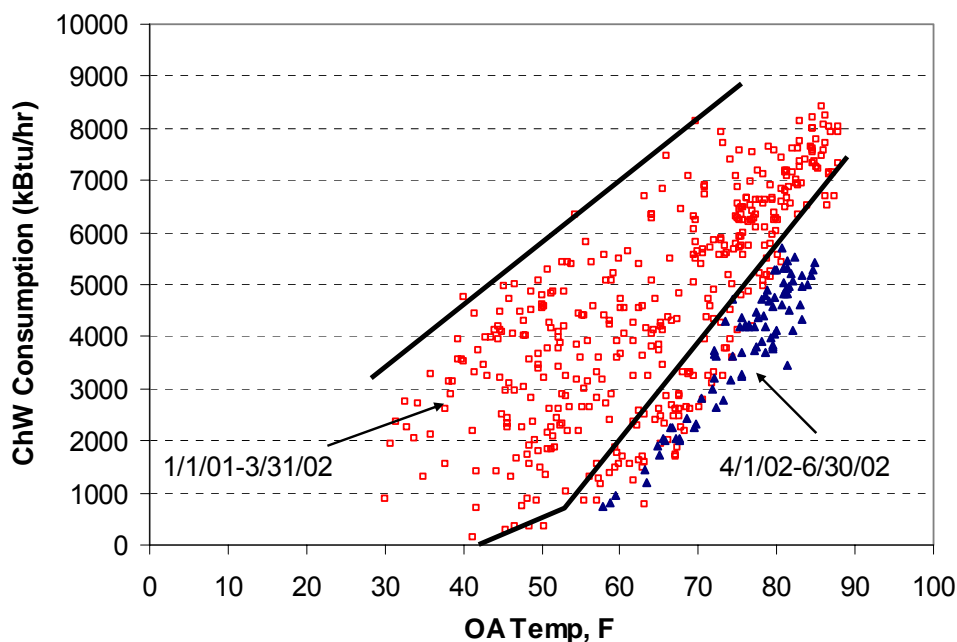

Figure 37: Cooling consumption in a building in which post-commissioning component failures led to increased consumption (from Claridge et al. 2002).

Ginestet and Marchio (2003), have developed a building simulation program within Annex 40 that combines a dynamic envelope model with simulation of the air distribution system, control system, and ventilation model that is configured to encourage use for fault detection in applications such as on-going commissioning. It can readily be used for a number of other applications as well.

### ***On-Line Simulation as a Commissioning Follow-up Tool***

A design simulation or a calibrated simulation may (in principle) be embedded in the BEMS. It could then serve as an alarm any time consumption deviates beyond an alarm limit. It may also be used to evaluate the impact of any control changes implemented – comparison of measured performance with simulation results would show whether performance has improved or degraded as a result of the changes.

Liu et al. (2002) presents the results of a study of the potential for using simulation programs for on-line fault detection, problem diagnosis, and operational schedule optimization for large commercial buildings with built-up HVAC systems. Within the Annex 40 context of subtask D2, this report examines the potential for the use of calibrated whole building simulation for retro-commissioning and for on-going commissioning.

This study reviewed over a dozen simulation programs used in the U.S. and determined that AirModel and EnergyPlus were most suitable for use in the on-line simulation applications that were the focus of the study. These programs cover both ends of a spectrum from a relatively simple program that can be used quickly and perhaps embedded in an BEMS for on-line simulation to one of the more detailed and flexible simulation program available. Energy-Plus requires more computational resources than are available for this purpose in a typical BEMS today.

### ***Use of Simulation to Evaluate New Control Code***

New control code can be tested by a simulation before actually putting it into the system and activating this mode of control. Baumann (2003) has used this approach to optimize the control of the water supply temperature for heating and cooling in a new school. Wang (2003) has developed a new simulation tool particularly intended to permit rapid evaluation of the dynamic performance of a building at short time steps suitable for evaluation of control code.

Baumann (2003) used a TRNSYS simulation in conjunction with the GenOpt program to develop an optimal control strategy for the heating and cooling water supply temperatures in a 10,000 m<sup>2</sup> vocational school in Biberach, Germany. This school was scheduled for completion in the summer of 2004 and incorporates an embedded hydronic heating and cooling (EHHC) system consisting of flexible tubes embedded in massive concrete ceilings. Water heated by a heat pump or cool ground water is supplied to the EHHC system, depending on whether heating or cooling is required in the building.



The massive ceilings have a very long combined time constant, so controlling the temperature of the water supplied to the system is critical to minimize the number of occupied hours when the space temperatures are either too hot or too cold. The control scheme adopted uses the median temperature values for the last three days (with the most recent day double-weighted) to define the "median" outdoor temperature that determines the temperature of the supply water. The supply water temperature varies between a maximum value of 28°C and a neutral value of 21°C as "median" outdoor temperature varies between values of  $T_{o,heat,max}$  and  $T_{o,heat,min}$ . The supply temperature is maintained at 21°C until the "median" outside temperature increases to  $T_{o,cool,min}$ . The supply temperature then starts to decrease linearly toward 18°C at a temperature of  $T_{o,cool,max}$ . The supply temperature is held constant at 18°C for temperatures above  $T_{o,cool,max}$  and is held constant at 28°C for temperatures below  $T_{o,heat,max}$ .

The simulation was used to optimize the values of  $T_{o,heat,max}$ ,  $T_{o,heat,min}$ ,  $T_{o,cool,min}$ , and  $T_{o,cool,max}$ , to minimize heating and cooling energy subject to the constraints that the room temperature never go below 21°C and go above 26°C for only a small number of hours. It was found that the optimum heating consumption was only half the maximum value produced by an alternate control scheme that produced equivalent comfort.

Wang (2003) has developed a hybrid model suitable for rapid short time-step simulation of the dynamic performance of buildings - hence suitable for control simulation and optimization. This hybrid model uses a 3R2C model of the building envelope, with the sum of the three resistances constrained by the total resistance of the envelope and the total capacitance constrained by the total thermal capacitance of the envelope. Wang used a genetic algorithm to choose optimum values for the resistances and capacitances so the frequency response and phase lag of the 3R2C model closely approximates that of the theoretical model for the walls at all but the highest frequencies. The same technique is used to develop optimal parameters for a 2R2C model of the interior mass in the building by searching in the time domain.

This model was developed in part to determine optimal control strategies for night ventilation and off-peak precooling to take advantage of a 'time of use rate' that was implemented in Hong Kong in 2001.

## 6.2.5 REFERENCES

Adam C., Andre P., Aparecida Silva C., Hannay J., and Lebrun J., "Commissioning Oriented Building Loads Calculations. Application to the CA-MET Building in Namur (Belgium)," Proc. of International Conference for Enhanced Building Operations, ICEBO, Paris, 2004 CD.

Andre P., Cuevas, Lacote and Lebrun J., "Re-Commissioning of the CAMET HVAC System: A Successful Case Study" Proc. of International Conference for Enhanced Building Operations, Berkeley, CA, 2003a.

Andre P., Fonseca, Hannay J., Hannay-Silva, Lacote, and Lebrun J., "Re-Commissioning of a VAV Air-Distribution System," A40-D- M6-BEL-UL, 2003b.

ANSI/ASHRAE 2001, Standard 140-2001, Standard Method of Test for the Evaluation of Building Energy Analysis Computer Programs.



Baumann O., "Design and Optimization of Control Strategies and Parameters by Building and System Simulation," Proc. International Conference for Enhanced Building Operations. Berkeley, CA, 2003 CD.

Carling P., Isakson P., Blomberg P. and Eriksson J., "Simulation-Aided Commissioning of the Katsan Building." A40-D-M5-SWE-AF/KTH -1,2003a.

Carling P., Isakson P., Blomberg P. and Eriksson J., "Experiences from Evaluation of the HVAC Performance in the Katsan Building Based on Calibrated Whole-Building Simulation and Extensive Trending." A40-D-M6-SWE-AF/KTH-2, 2003b.

Carling P., Isakson P. and Blomberg P., "Whole-Building Simulation in Commissioning — Experiences from the Katsan-project." A40-D2-M8-SWE-ÅF/KTH-1, 2004.

Chen H., Song D., Bruner H., Claridge D. and Turner W.D, "Continuous CommissioningSM Results Verification And Follow-Up For An Institutional Building - A Case Study," Proc. 13th Symposium on Improving Building Systems in Hot and Humid Climates, TX, pp. 87-95. Houston, 2002.

Claridge, D. and Liu, M., "Using Whole Building Simulation Models in Commissioning." A40-D2-M4-US-TAMU-02, 2002.

Claridge, D.E., Turner, W.D., Liu, M., Deng, S., Wei, G., Culp, C., Chen, H. and Cho, S.Y., 2002, "Is Commissioning Once Enough?," Solutions for Energy Security & Facility Management Challenges: Proc. of the 25th WEEC, Atlanta, GA, Oct. 9-11, 2002, pp. 29-36.

Claridge, D.E., Bensouda, N., Lee, S.U., Wei, G., Heinemeier, K., and Liu, M., 2004, "Methodology For Calibrating Simulations," A40-D2-M8-US-TAMU-1.

European Parliament, 2002, Directive 2002/91/EC of the European Parliament and of the Council of 16 December 2002 on the Energy Performance of Buildings. [http://europa.eu.int/eur-lex/pri/en/oj/dat/2003/1\\_001/1\\_00120030104en00650071.pdf](http://europa.eu.int/eur-lex/pri/en/oj/dat/2003/1_001/1_00120030104en00650071.pdf).

Ginestet S. and Marchio D., "IAQ-Op (Indoor Air- Quality in Operation): A Simulation Tool for Retro-Commissioning, On-Going-Commissioning and Fault Simulation." A40-D2-M5-F-ELYO-03, 2003.

Haves P., Salsbury T., Claridge D., and Liu M., "Use Of Whole Building Simulation In On-Line Performance Assessment: Modeling And Implementation Issues," Proc. of International Building Performance and Simulation Conference, Rio Di Janeiro, Brazil, 2001.

Holst J., "Using Whole Building Simulation Models and Optimizing Procedures to Optimize Building Envelope Design with Respect to Energy Consumption and Indoor Environment," A40-D2-M5-NO-JNH-01, 2003.

IDA, 2002, Indoor Climate and Energy, EQUA Simulation AB, Sweden, 243 pp., [http://www.eere.energy.gov/buildings/tools\\_directory/software/idaice.htm](http://www.eere.energy.gov/buildings/tools_directory/software/idaice.htm), June 24, 2004.

IEA 1995, Building Energy Simulation Test (BESTEST) and Diagnostic Method, National Renewable Energy Laboratory, Golden, Colorado, February.

IPMVP Committee, International Performance Measurement & Verification Protocol: Concepts and Options for Determining Energy and Water Savings, Vol. 1, U.S. Dept. of Energy, DOE/GO-102001-1187, 86 pp., January, 2001.

Keranen H. and Kalema T., "Commissioning of the IT-Dynamo Building," A40-D2-M6-FI-TUT-01, 2003.

Keranen H. and Kalema T., "Commissioning Educational Building IT-Dynamo Building," A40-D2-M7-FI-TUT-01, 2004a.

Keranen H., Kalema T. and Pesonen A., "Experiences of Using Models and Information of Building Automation System in Commissioning," Proc. of International Conference for Enhanced Building Operations, ICEBO, Paris, 2004 CD.

LBL, The Reference to EnergyPlus Calculations, Energy Plus Engineering Document, Lawrence Berkeley National Laboratory, 2001.

Liu M. and Claridge D.E., "Application of Calibrated HVAC System Models to Identify Component Malfunctions and to Optimize Operation and Control Schedules," Solar Engineering 1995 - Proceedings of the 1995 ASME/JSME/JSES International Solar Energy Conference, Vol. 1, Maui, Hawaii, P. 209-217, 1995.

Liu M., User's Manual for Air Side Simulation Programs (AirModel). Energy Systems Laboratory, Mechanical Engineering Department, Texas A&M University, College Station, Texas, 1997.

Liu M., Zhu Y., Park B.Y., Claridge D.E. and Feary, D.K., "Airflow Reduction to Improve Building Comfort and Reduce Building Energy Consumption – A Case Study," ASHRAE Transactions-Research, Vol. 105, Part I, P. 384 – 390, 1999.

Liu M., Song L., and Claridge D.E., "Potential of On-Line Simulation for Fault Detection and Diagnosis in Large Commercial Buildings with Built-Up HVAC Systems." A40-D2-M4-US-TAMU-01, 2002a.

Liu C., Turner W.D., Claridge D., Deng S. and Bruner, H.L., "Results of CC Follow-Up in the G. Rollie White Building," Proc. 13th Symposium on Improving Building Systems in Hot and Humid Climates, May 20-23, Houston, TX, P. 96-102. 2002b.

Niwa H., Nakahara N., Okumiya M., Suganaga M., Tanaka H., Pan S., Watanabe T., and Zheng M., "Comparative Study of Availability on Energy/Environment Commissioning Using Existing HVAC Simulation Programs for a Model Building," Proc. of International Conference for Enhanced Building Operations, ICEBO, Paris, 2004, CD.

RIUSKA (2003), [http://www.eere.energy.gov/buildings/tools\\_directory/software/riuska.htm](http://www.eere.energy.gov/buildings/tools_directory/software/riuska.htm), June 24, 2004.

Sagara N., Ishida J., Takeda H. and Shioya M., "Analysis of Seasonal Chilled Water Thermal Quantity Consumption for HVAC Systems in a Commercial Building: Study of a Method of Macroscopic Diagnosis of Energy Consumption in Buildings." A40-D-M5-J-KTAK-1, 2003.

Selkowitz S. E., Haberl J. S. and Claridge D. E., "Future Directions: Building Technologies and Design Tools," Proceedings of the ACEEE 1992 Summer Study on Energy Efficiency in Buildings, Volume 3, American Council for an Energy Efficient Economy, Washington, D.C., P. 269-290, 1992.

Tsubota Y. and Kawashima M., "Online Building Energy Evaluation Systems." A40-D-M5-J-TEPCO-2-rev1, 2003.

Turner W.D., Claridge D.E., Deng S., Cho S., Liu M., Hagge T., Darnell C. Jr., and Bruner H. Jr., "Persistence of Savings Obtained from Continuous CommissioningSM," Proc. of 9th National Conference on Building Commissioning, Cherry Hill, NJ, May 9-11, pp. 20-1.1 - 20-1.13, 2001.

Wang S. and Xu X., "Hybrid Model for Building Performance Diagnosis and Optimal Control," Proc. International Conference for Enhanced Building Operations, Berkeley, CA, Oct. 13-15, CD, 2003.

Wetter M., "GenOpt – A Generic Optimization Program," Proc. Seventh International IBPSA Conference, pp. 601-8, Rio de Janeiro, Brazil, August 13-15, 2001.

## 7. VISIT COMMISSIONING PROJECTS

A collection of 27 demonstration sites has been used to assess the Commissioning tools developed within the Annex. Each participating country has been involved in at least one commissioning project.

The objectives were :

- To test and to improve the procedure developed
- To demonstrate the advantage of commissioning

This mandatory involvement of all partners in real projects also enabled an in-depth interaction with potential users of the tools developed within the Annex.

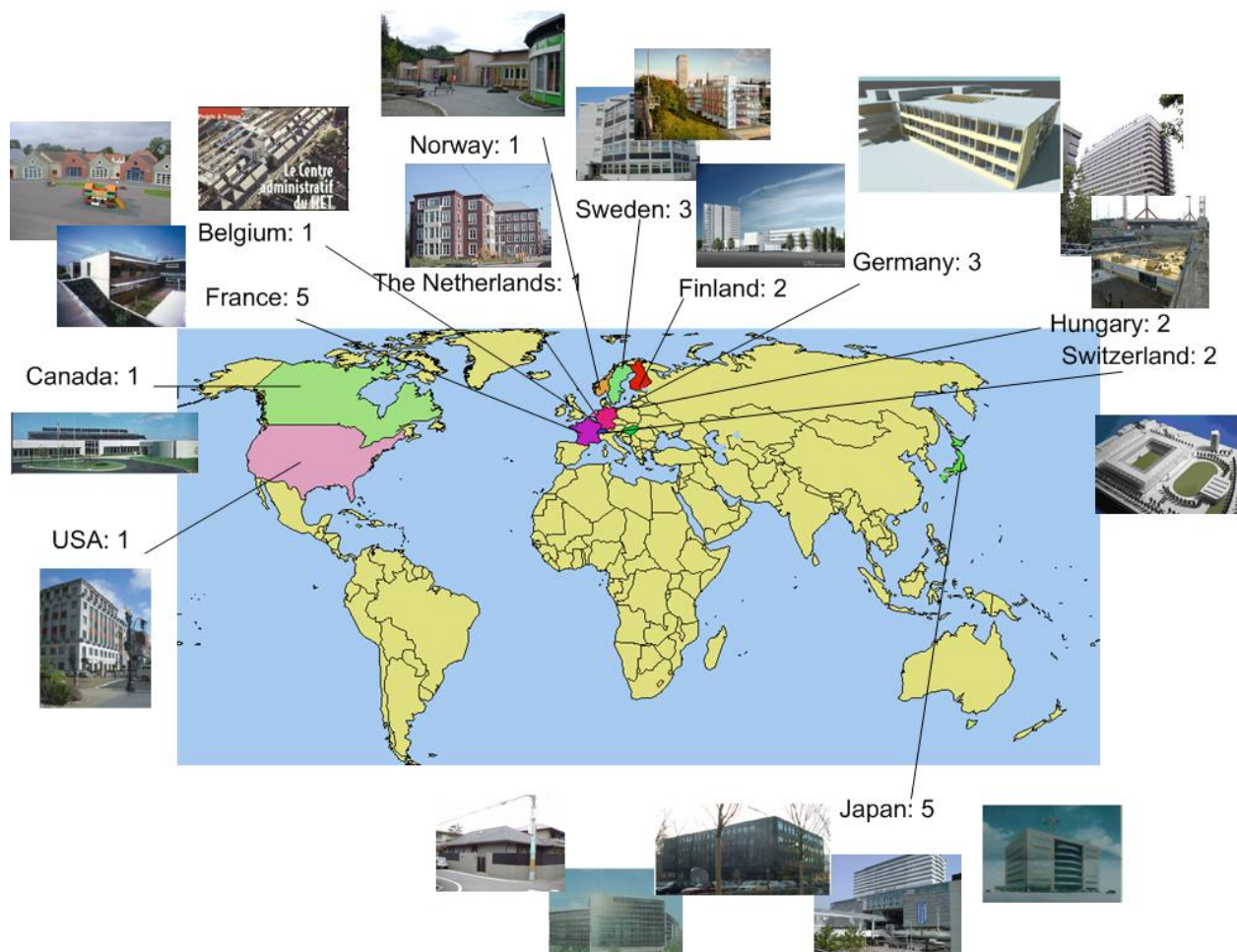

Figure 38: location of the demonstration sites

## 7.1 LIST OF CASE STUDIES

A total of 27 case studies have been reported, the projects are listed in table 12, ordered by countries.













	Building's name	Type				Size (m <sup>2</sup> )	Phase			Cx type			Tools tested		
		School	Office	Lab & Office	Other		Design	Construction	Operation	Ini Cx	Re Cx	C Cx	Manual	BEMS assisted	Simulation
	CA-MET headquarters of the Ministry of Equipment and Transport		<input checked="" type="checkbox"/>			15000		<input checked="" type="checkbox"/>		<input checked="" type="checkbox"/>		<input checked="" type="checkbox"/>			
	CANMET Energy Technology Centre			<input checked="" type="checkbox"/>		3600		<input checked="" type="checkbox"/>		<input checked="" type="checkbox"/>	<input checked="" type="checkbox"/>		<input checked="" type="checkbox"/>		
	GMS	<input checked="" type="checkbox"/>				10000	<input checked="" type="checkbox"/>		<input checked="" type="checkbox"/>			<input checked="" type="checkbox"/>		<input checked="" type="checkbox"/>	
	BSZ	<input checked="" type="checkbox"/>				2500		<input checked="" type="checkbox"/>		<input checked="" type="checkbox"/>		<input checked="" type="checkbox"/>	<input checked="" type="checkbox"/>		
	Munchener Ruckversicherung		<input checked="" type="checkbox"/>			9100		<input checked="" type="checkbox"/>		<input checked="" type="checkbox"/>			<input checked="" type="checkbox"/>	<input checked="" type="checkbox"/>	
	Nursery school of Crevecoeur legrand	<input checked="" type="checkbox"/>				2700		<input checked="" type="checkbox"/>	<input checked="" type="checkbox"/>			<input checked="" type="checkbox"/>	<input checked="" type="checkbox"/>		
	Aria, Research building of CSTB			<input checked="" type="checkbox"/>		2000		<input checked="" type="checkbox"/>		<input checked="" type="checkbox"/>		<input checked="" type="checkbox"/>	<input checked="" type="checkbox"/>		
	PB6 headquarters of EDF		<input checked="" type="checkbox"/>			63200		<input checked="" type="checkbox"/>		<input checked="" type="checkbox"/>				<input checked="" type="checkbox"/>	
	Schools of the town of Paris	<input checked="" type="checkbox"/>				500-5000		<input checked="" type="checkbox"/>			<input checked="" type="checkbox"/>		<input checked="" type="checkbox"/>		
	University Rhone-Alpes	<input checked="" type="checkbox"/>				600		<input checked="" type="checkbox"/>		<input checked="" type="checkbox"/>	<input checked="" type="checkbox"/>			<input checked="" type="checkbox"/>	
	Dynamo building of Jyväskylä Polytechnic	<input checked="" type="checkbox"/>				10000		<input checked="" type="checkbox"/>			<input checked="" type="checkbox"/>			<input checked="" type="checkbox"/>	
	Digital building			<input checked="" type="checkbox"/>		8300	<input checked="" type="checkbox"/>		<input checked="" type="checkbox"/>					<input checked="" type="checkbox"/>	
	Cultural Palace				<input checked="" type="checkbox"/>	60000		<input checked="" type="checkbox"/>		<input checked="" type="checkbox"/>		<input checked="" type="checkbox"/>	<input checked="" type="checkbox"/>		
	NH Eurobuilding Hotel (Spain)				<input checked="" type="checkbox"/>	50100		<input checked="" type="checkbox"/>		<input checked="" type="checkbox"/>		<input checked="" type="checkbox"/>	<input checked="" type="checkbox"/>		
	K Building				<input checked="" type="checkbox"/>	86000		<input checked="" type="checkbox"/>	<input checked="" type="checkbox"/>					<input checked="" type="checkbox"/>	
	Shinkawa building		<input checked="" type="checkbox"/>			5400		<input checked="" type="checkbox"/>		<input checked="" type="checkbox"/>		<input checked="" type="checkbox"/>	<input checked="" type="checkbox"/>		
	Tepco Building		<input checked="" type="checkbox"/>			16765		<input checked="" type="checkbox"/>	<input checked="" type="checkbox"/>			<input checked="" type="checkbox"/>	<input checked="" type="checkbox"/>		
	Yamatake research centre			<input checked="" type="checkbox"/>		1692		<input checked="" type="checkbox"/>	<input checked="" type="checkbox"/>				<input checked="" type="checkbox"/>		
	O House, residential building				<input checked="" type="checkbox"/>	150		<input checked="" type="checkbox"/>	<input checked="" type="checkbox"/>				<input checked="" type="checkbox"/>	<input checked="" type="checkbox"/>	
	Postbank office building				<input checked="" type="checkbox"/>	7000		<input checked="" type="checkbox"/>			<input checked="" type="checkbox"/>		<input checked="" type="checkbox"/>		
	primary school of Trondheim	<input checked="" type="checkbox"/>				1600		<input checked="" type="checkbox"/>		<input checked="" type="checkbox"/>		<input checked="" type="checkbox"/>			
	KV Valten		<input checked="" type="checkbox"/>			1200		<input checked="" type="checkbox"/>	<input checked="" type="checkbox"/>					<input checked="" type="checkbox"/>	
	KV Katsan		<input checked="" type="checkbox"/>			6300	<input checked="" type="checkbox"/>		<input checked="" type="checkbox"/>					<input checked="" type="checkbox"/>	
	Kista Entré		<input checked="" type="checkbox"/>			46000		<input checked="" type="checkbox"/>	<input checked="" type="checkbox"/>				<input checked="" type="checkbox"/>	<input checked="" type="checkbox"/>	
	Swiss federal institute for forest, snow and landscape			<input checked="" type="checkbox"/>		3675		<input checked="" type="checkbox"/>		<input checked="" type="checkbox"/>		<input checked="" type="checkbox"/>			
	Wankdorf Bern New stadium and commercial centre				<input checked="" type="checkbox"/>	5500	<input checked="" type="checkbox"/>		<input checked="" type="checkbox"/>			<input checked="" type="checkbox"/>			
	Government office building of the City of Oakland		<input checked="" type="checkbox"/>			6300	<input checked="" type="checkbox"/>		<input checked="" type="checkbox"/>					<input checked="" type="checkbox"/>	

Table 12: list of the demonstration sites

## 7.2 TYPOLOGIES

The collection of demonstration sites includes a variety of building types (Figure 40) (commercial or residential), building sizes (Figure 39) (from 100 to 86000m<sup>2</sup>), new and existing buildings, etc. in order to test a large panel of commissioning tools (manual, automatic, using models) and different stages of the building construction process (from the conception to the operation).

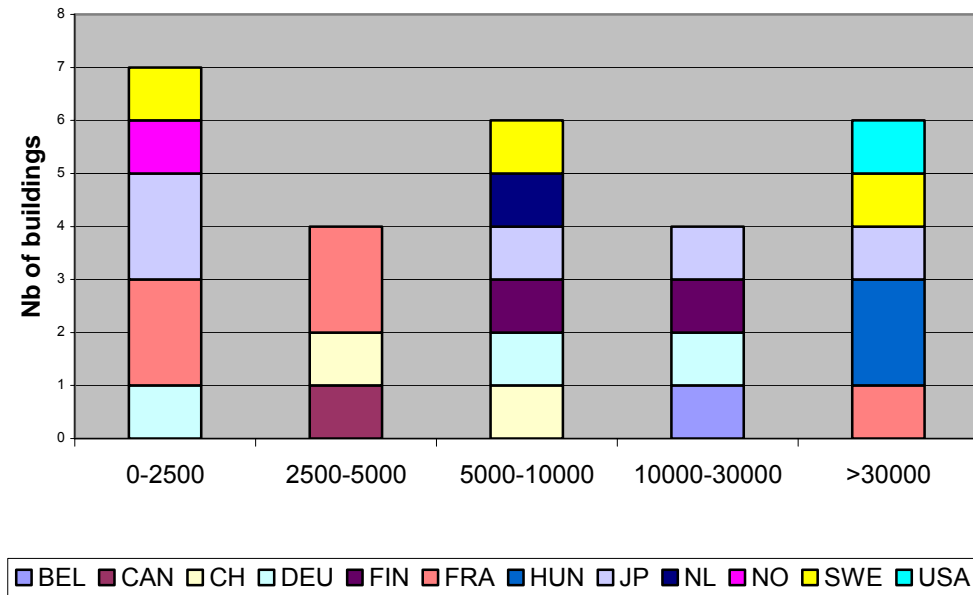

Figure 39: size of the demonstration sites

Most of the team worked on commercial buildings. One project (O House-Japan) is a residential building. The French team developed a tools dedicated to a stock of buildings (about 700 schools). The cost of the com missioning work is one of the main arguments to curb the commissioning development in small buildings.

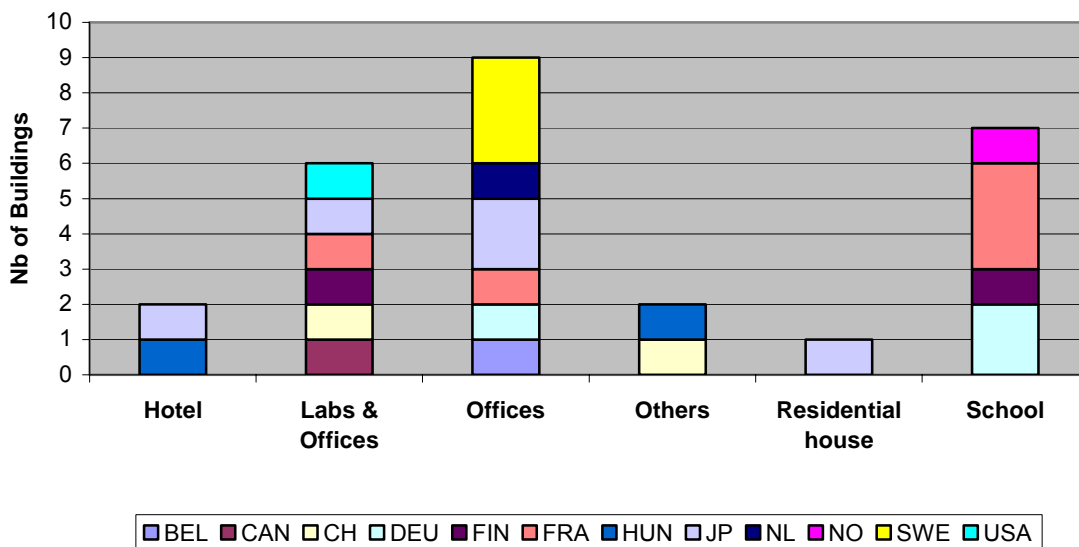

Figure 40: Type of buildings used as demonstration site



The commissioning needs are linked to the size of buildings, HVAC systems complexity, criticalness of HVAC systems and interest of the clients in the final results.

In the collection of the demonstration sites (except the residential case) ,we noticed 2 main groups:

- medium size buildings between 500 m<sup>2</sup> and 5000 m<sup>2</sup> (30% of the buildings)
- large commercial buildings more than 10000 m<sup>2</sup> (50% of the buildings)

A large part of the team involved in Annex 40 have developed tools to improve the operation phase,Figure 41.

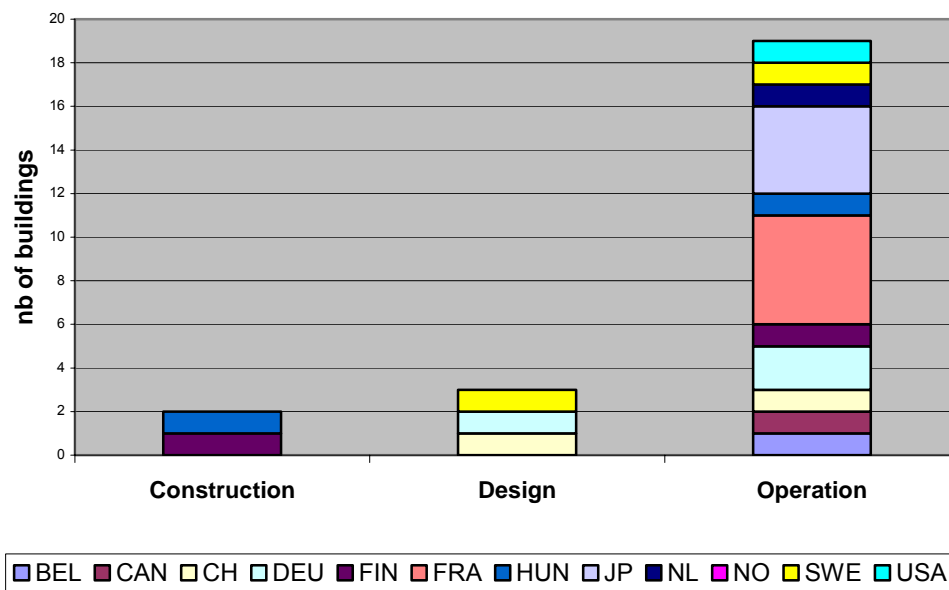

Figure 41: Phase of the construction concerned by the Commissioning

The repartition of the case studies is roughly the same between Initial commissioning (dedicated to new building) and other commissioning types (dedicated to existing building), Figure 42.

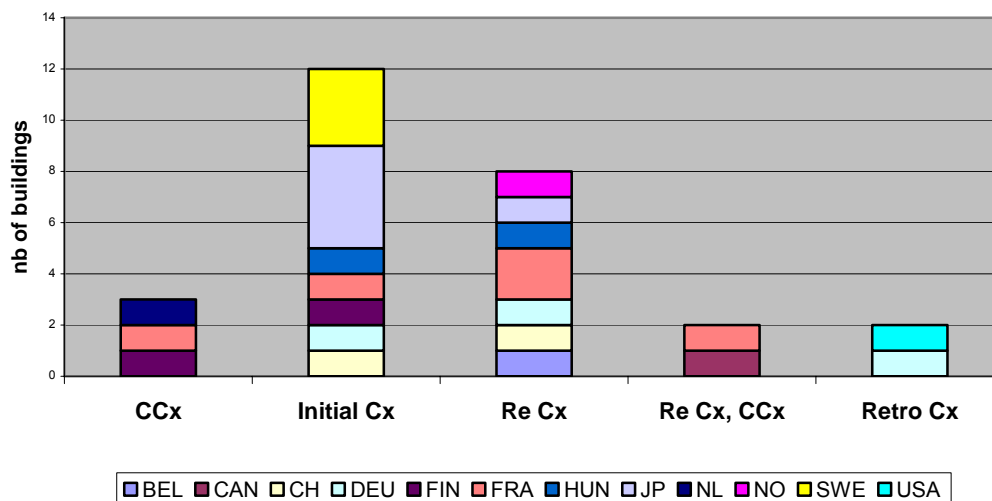

Figure 42: Type of Commissioning targeted on the demonstration sites

The type of tools developed within the Annex were mainly dedicated to the Handover, to check that the technical installation works properly and operation phases to finalize the tuning of the HVAC system and to optimize the performance of the whole building in term of energy consumption, cost of operation and comfort.

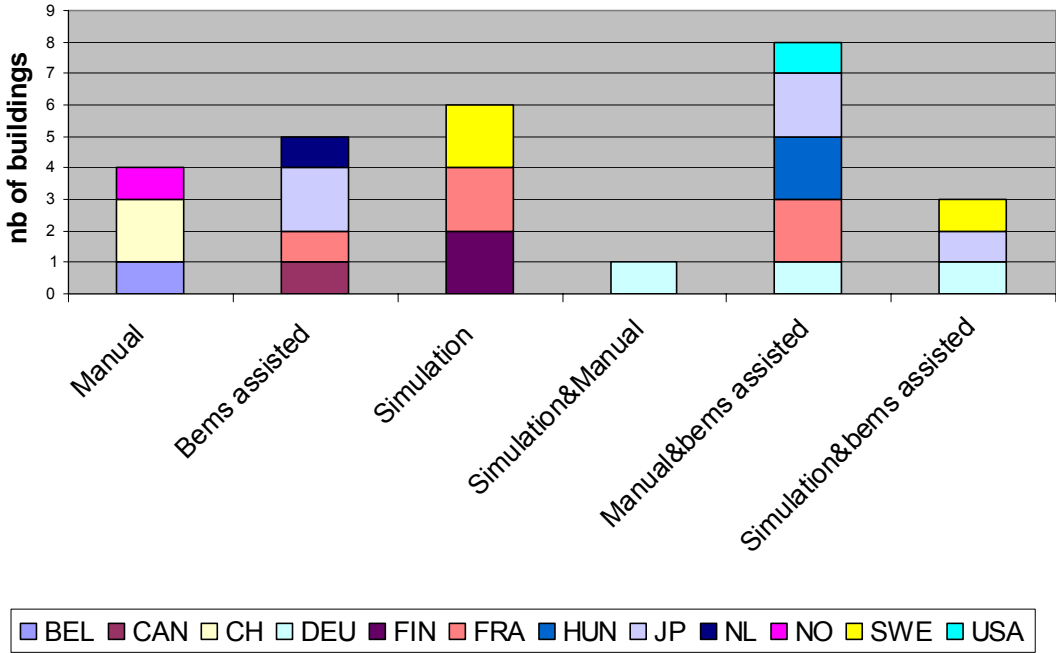

Figure 43: Type of tools tested on the demonstration sites

### 7.3 DATABASE OF THE CASE STUDIES

A data base of commissioning projects has been developed throughout the Annex in order to collect and share the information as the work progresses and to underline the link between building, commissioning type, tools developed and users.

The description of all the case studies includes:

- a concise description (poster)\*
- a detailed paper
- a description of the tools assessed on the site

\* All the posters can be found in Annex 2.



## APPENDIX 1: GLOSSARY

Bénédicte Viaud (EDF, France)  
Natascha Castro (NIST, USA)  
Yasunori Akashi (Kyushu Univ., Japan)  
Vojislav Novakovic (NTNU, Norway)  
Mireille Jandon (CSTB, France)

Defining ‘Commissioning’ terms is necessary for common international understanding. This Glossary, which was originally based on different existing guidelines [1, 2, 3] and discussions in Annex 40 meetings, is one of the commissioning tools developed in Annex 40. Actually, it may be impossible to apply the Glossary to all cases because ‘Commissioning’ is deeply connected with the social structure of a country and/or characteristics of a commissioning project. The Glossary is basically written as a set of ideal definitions and explanations, and may be customized according to the country, state and commissioning project.

Generally, there are four representative types of Commissioning Process. More detailed explanations are shown in the following part.

- (1) **Initial Commissioning (I-Cx):** I-Cx is a systematic process applied to production of a new building and/or an installation of new systems.
- (2) **Retro-Commissioning (Retro-Cx):** Retro-Cx is the first time commissioning is implemented in an existing building in which a documented commissioning process was not previously implemented.
- (3) **Re-Commissioning (Re-Cx):** Re-Cx is a commissioning process implemented after I-Cx or Retro-Cx when the owner hopes to verify, improve and document the performance of building systems.
- (4) **On-Going Commissioning (On-Going Cx):** On-Going Cx is a commissioning process conducted continually for the purposes of maintaining, improving and optimizing the performance of building systems after I-Cx or Retro-Cx.

The Glossary mainly has terms related to I-Cx because Annex 40 has emphasized I-Cx. Consequently, the Glossary may not be completely applicable to the other types of commissioning, but it could give useful information.

The Glossary consists of five parts; A. Definition of Basic Terms, B. Explanation of Terms, C. Commissioning Types, and D. Commissioning Process.

In the ‘Definition of Basic Terms’ section, commissioning terms which have been deemed essential to understand the meaning of ‘Commissioning’ are defined in short sentences and listed alphabetically. In the ‘Explanation of Terms’ section, supplemental explanations of the basic terms in part A and some terms used in the commissioning process are provided as necessary. In the ‘Commissioning Types’ and ‘Commissioning Process’ sections, terms needed to construct a frame for commissioning are described in detail. These terms include different commissioning types (i.e. ‘Initial Commissioning (I-Cx)’, ‘Re-Commissioning (Retro-Cx)’, etc.), phases and steps shown in the commissioning process. The detailed descriptions of these terms facilitate the understanding of commissioning projects.

The chart in Figure 1 shows the flow of commissioning documents to illustrate typical steps in a comprehensive commissioning process. The figure is divided into eight color-coded rows. It uses colored blocks to represent documents that must be prepared and white blocks to represent actions that must be completed. Dashed lines show the flow of actions (i.e., selecting the Design Professional based on the RFP\_Des) and the solid lines show the flow of the document (i.e., the OPR is developed based on the documents of OP and DR). The first three rows provide column headings for each of the commissioning stages, phases and steps, and the fourth row shows the tasks and key documents that relate to the owner. Similarly, rows five through seven show the role of the commissioning authority, design professional and contractor, respectively. The last row shows the commissioning types as a timeline for the activities with initial commissioning process feeding into the other commissioning types. The terms shown in the figure are linked to the definitions and explanations described in parts A to D in the electronic version of the final report.

Furthermore, Annex 40 developed the glossary database system which is utilized on the website. It enables one to search, see, create and modify the definitions and explanations of terms. The base language is English with translations provided in Finnish, French, German, Japanese, and Norwegian. Definitions published by ASHRAE are also provided in the system.

Figure 2 is a screen capture of the web-based tool. The features of the tool are as follows. Below the heading of Commissioning-HVAC Glossary of Terms, is a row of letters, each of which provides a quick link for terms beginning with that letter. The shaded box on the left side is a table of contents/menu that is separated into four sections. The first section provides a link to the glossary home page that gives an overview of the contents as well as a search tab to enable users to locate specific terms. The second section lists the results of the alphabetic lookup. The third section provides links to the definitions of commissioning types and explanations of the commissioning phases and the flow diagram to show the commissioning process overview (Figure 1). Finally, the fourth section provides a link to the Administration section that is used by the glossary team to file comments to add a term, modify a term, or provide a translation.

The easiest way to use the glossary is to utilize the glossary database system or the electronic version. The electronic version of the glossary is directly linked from terms used in other Annex 40 electronic documents to aid readers.

## REFERENCES

1. ASHRAE Terminology of HVAC&R, American Society of Heating Refrigeration and Air-conditioning Engineers, Atlanta, USA, 1991.
2. ASHRAE Guideline 1-1996, The HVAC Commissioning Process, American Society of Heating Refrigeration and Air-conditioning Engineers, Atlanta, USA, 1996.
3. SHASE Commissioning Guideline, Society of Heating Refrigeration and Air-conditioning and Sanitary Engineers, Tokyo, Japan, 2003.

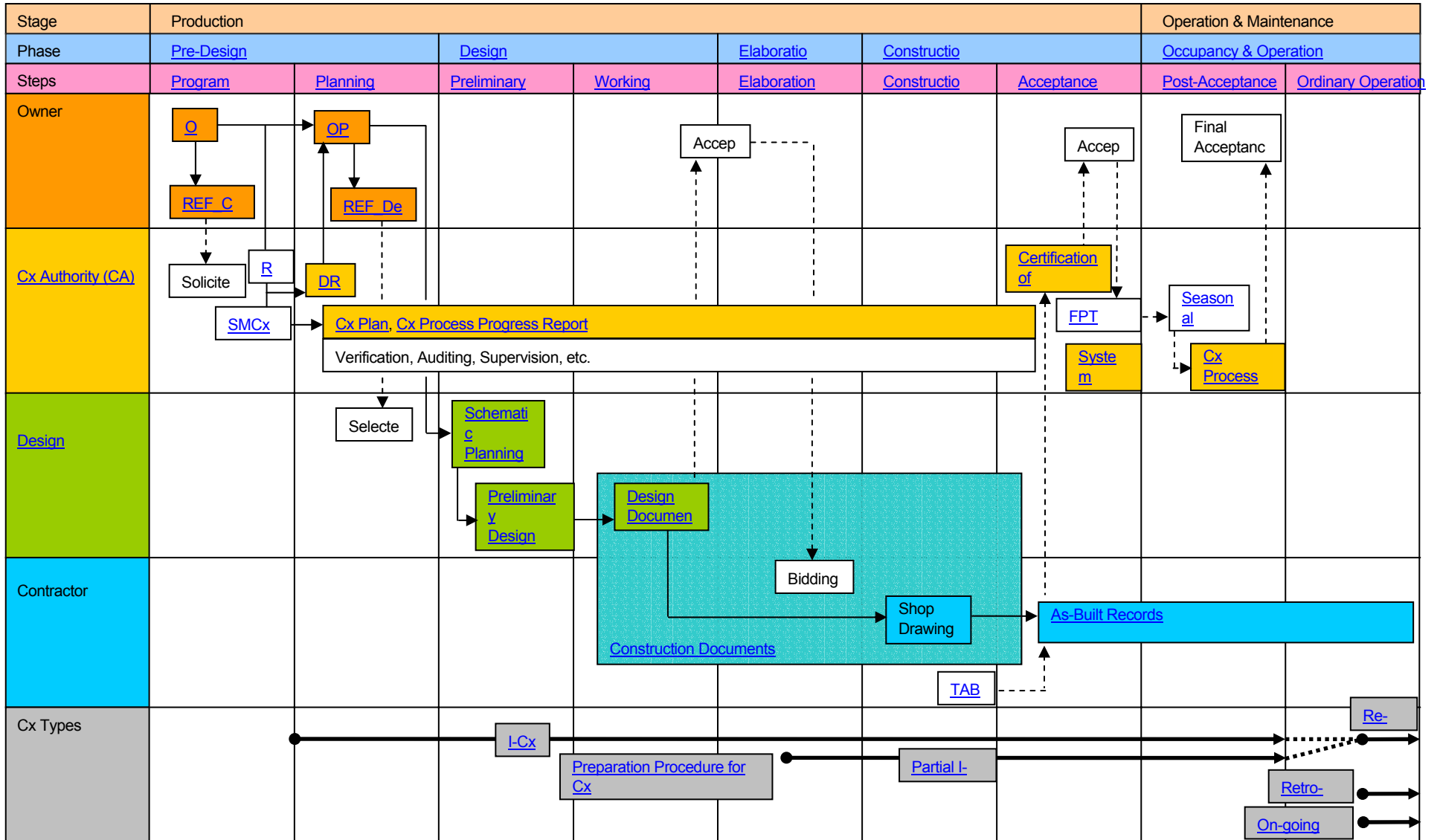

Figure 44: Commissioning process and document flow



Figure 45: Glossary database system (screen capture)

## A. Definition of Basic Terms

**Acceptable Performance:** Permissible environmental and energy performance values for equipment and systems (i.e. seasonal/time fluctuations and space distributions occurring under all ranges of actual loads).

**Active Test:** A test to assess performance by analyzing data obtained from systems that are subjected to artificial changes in operational conditions.

**As-Built Records:** Documents that accurately represent actual installed conditions, equipment, and systems, such as drawings, computer graphics, equipment data sheets, operation manuals, and maintenance manuals. They also include the training program and training videotapes.

**Basis of Design:** All information necessary to accomplish the design requirements, including weather data, interior environmental criteria, other pertinent design assumptions, cost goals, references to applicable codes, standards and regulations, and guidelines and tools for prediction of environmental and energy performance.

**BEMS-assisted Commissioning:** Making use of the control system to perform commissioning procedures. Typically, the control system is used as a means of interfacing to energy systems in buildings through sensor and control signals.

**BEMS-assisted Commissioning Tool:** An automated software tool that monitors building control data and stores it in a structured database to be used on-line or upon request.

**Certificate of Readiness:** A document stating that all equipment, systems, and controls have been correctly installed; operated as specified; tested, adjusted and balanced; and are verified as ready for functional performance testing and other acceptance procedures. The commissioning authority issues the certificate of readiness to the contractor after verifying the results.

**Checklist:** SMCxP customized for practical use.

**Commissioning (Cx):** Clarifying building system performance requirements set by the owner, auditing different judgments and actions by the commissioning related parties in order to realize the performance, writing necessary and sufficient documentation, and verifying that the system enables proper operation and maintenance through functional performance testing. Commissioning should be applied through the whole life of the building.

**Commissioning Authority (CA):** A person, company or organization designated by the owner, responsible for managing the overall commissioning process.

**Commissioning Plan:** A document written by the commissioning authority that defines the contents of the commissioning process according to the project risk and complexity in order to completely finish each commissioning phase and/or step. The commissioning plan can be defined through customization of standard models of commissioning plans.

**Commissioning Process (CxP):** A quality-oriented process to accomplish the commissioning aim.

**Commissioning Process Progress Report:** A progress report submitted during the commissioning process by the commissioning authority to the owner when a phase or step in the commissioning process, a contract deliverable, or the budget year is finished.

**Commissioning Process Report:** A final report on the results of the commissioning submitted by the commissioning authority to the owner. In the case that commissioning is needed in the post-acceptance step of the initial commissioning process, a provisional commissioning process report is submitted in the acceptance step and the final report is submitted at the end of the post-acceptance step.

**Commissioning Related Parties:** The commissioning related parties cooperate with the commissioning managing team to share information, promote instruction and communication, and finally to implement the commissioning process smoothly. These parties include the owner, the designer, the contractor, etc. who are related to the project as described in the commissioning phases and steps.

**Commissioning Specification:** A document developed by the design professional as a part of design documents that details the objectives, scope, targeted items and performance description for the commissioning tasks following the design phase. It is based on the commissioning plan, and should be clearly shown to the contractors in the decision process such as in bidding.

**Commissioning Managing Team:** The commissioning managing team consists of the commissioning authority and the assistants. The design professional and the contractor for the project are not included in the commissioning managing team during the initial commissioning process to ensure independence of the commissioning process.

**Commissioning Team:** A generic term for the commissioning managing team and commissioning related parties, who cooperatively implement the commissioning process.

**Construction Documents:** Comprehensive documents for the construction bidding that summarize the design documents, the range and terms of construction, and additional documents needed for bidding.

**Design Documents:** Documents that detail all design work performed by the design professional including working design, construction specifications, the design intent document and the guide for system control and operation.

**Design Intent Document:** A document written by the design professional as a part of the design documents, which clearly states design intent, and provides an outline of the design and the basis of design. There are cases in which it includes the guide for system control and operation.

**Design Professional:** A legal representative in the design team for the project. In cases where a person and/or group within the design team have primary responsibility for the design, they can be called 'designer'.

**Design Requirements (DR):** A document on the basic performance conditions for the design summarized by the commissioning authority and based on the owner's program.

**Fault Detection and Diagnostic Tool (FDD Tool):** An automated software tool that assists the building operator in maintaining optimal operation of mechanical systems.

**Functional Performance Testing (FPT):** A set of tests that define the functionality and verify the behavior of a system. These tests are usually defined by the commissioning authority in order to verify that building systems are completed to satisfy the owner's project requirements and demonstrate functional performance.

**Guide for System Control and Operation:** A guide written by the designer from the design viewpoint and intended to inform operating and maintenance personnel of the system design intent, system structure, system control, and provide guidelines for system operation.

**Issues Log:** A formal document that records questions, answers, problems and resolutions occurring during the commissioning process.

**Owner's Program (OP):** A document written by the owner that describes the owner's vision of the project.

**Owner's Project Requirements (OPR):** A document based on the owner's program and the design requirements. The owner develops it with help from the commissioning authority.

**Passive Test:** A test to assess performance by analyzing data obtained from systems operating under normal conditions.

**Preparation Procedure for Commissioning Starting at Construction Phase:** Specific actions that should be performed before the construction phase when commissioning of pre-design phase and design phase have not been implemented. They are implemented for clarifying the system performance requested in the commissioning.

**Request for Proposal (RFP):** A document written by the owner to solicit a commissioning authority or to select a design professional for the project. It is called a RFP\_CA or RFP\_Des.

**Risk Evaluation (RE):** A specification provided by the owner or the commissioning authority, in which the accepted risk level for the building's HVAC systems is fixed.

**Standard Models of Commissioning Plans (SMCxP):** Standard models which list typical tasks to be carried out in the commissioning process.

**System Manuals:** Summary documents describing system operation and maintenance. They are developed by the commissioning authority from the guide for system control and operation provided by the design professional and the system operation and maintenance manual provided by the contractor. They include additional information collected during the commissioning process.

**System Operation and Maintenance Manual:** A manual of system operation and maintenance for operating and maintenance personnel summarized by the contractor. It includes the handling manual for the equipment and systems, the seasonal operation changes needed, the guide for checking and cleaning, the correspondence in an emergency, etc.

**Testing, Adjusting and Balancing (TAB):** A testing and adjustment of constructed and installed equipment and systems conducted by a contractor to ensure that the equipment and systems operate to meet the specifications written in the design documents. It includes adjusting water flow in pipes, air flow in ducts, and tuning control parameters.



## B. Explanation of Terms

**Acceptable Performance:** The permissible values including time fluctuations, space distributions, etc. Examples include: for equipment, the basis of FPT; for systems, reference of simulation and basis of evaluation of actual measured data; and for environmental conditions can be evaluation of system control characteristics and capacity. Seasonal mean values of refrigerating machine and/or system's COP (Co-efficient of Performance), space mean values of indoor air temperature, etc. are given as the simple examples.

**BEMS-assisted Commissioning Tool:** Data resulting from standardized test procedures invoked manually or automatically could also be stored in the database. The tool is also capable of performing intelligent analyses of the monitored data, performing additional automated tests of HVAC components and systems, identifying faults and diagnosing them, and evaluating potential improvements in energy efficiency. It can be applied in I-Cx, Re-Cx, Retro-Cx and On-Going Cx.

**Checklist:** A system or building has its own characteristics and may require specific methods, tools and checkpoints for Commissioning. Those checkpoints can be gathered and arranged as a checklist for typical system or building. A CA or a project manager will use it when proceeding from one project phase to the next. Since effective tools and practical checkpoints vary from country to country, checklists should be made in each country.

**Commissioning (Cx):** Cx is performed under the supervision of a qualified CA for the purpose of ensuring that building systems are designed, installed and functionally tested, and are capable of being operated and maintained to meet OPR from viewpoints of environment, energy and facility usage. These viewpoints mean to maintain the indoor environment in healthy and comfortable conditions, to minimize the amount of energy consumed and discharged, to conserve the urban/global environment, to keep maintainability of the building systems and to give a long life to the building systems.

**Commissioning Authority (CA):** In some countries, the CA must be qualified or certified by an organization authorized by the nation or the state. The CA shall report directly to the owner. For the purpose of maintaining its independence, the CA is generally not the design professional or the contractor in the I-Cx process. The CA organizes a commissioning managing team that consists of person responsible for working together to carry out the CxP according to the project risk and complexity, plays a role of representative in the commissioning managing team, and finally submits the commissioning process report to the owner.

**Commissioning Plan:** The design professional develops the design documents including the commissioning specification, the estimation of Commissioning costs, etc., based on the OPR and the commissioning plan. Therefore, the commissioning plan should include necessary and sufficient information for conducting the Commissioning at each phase and step in the CxP. The CA needs to develop the commissioning plan in increasing detail according to the Commissioning progress in order to conduct the Commissioning correctly. Accordingly, the phase and/or step name and the version number should be included in the commissioning plan to confirm the latest information and the history.



**Construction Documents:** In a broad sense, the construction documents can include shop drawings added during construction, changes to design documents, admission documents, and the additional information on the construction bidding such as the tasks, responsibility, and costs sharing for completing the CxP.

**Design Documents:** The design documents are the basis for the contracts between the owner and the contractors, construction control and quality management after the design phase. Therefore, technical guidance for prediction of equipment performance, method of the system control, references for performance verification, required and estimated values of environmental and energy performance, the manual for system operation, commissioning specifications, etc. should be clearly described in the design documents. There are cases in which the budget of the project, the estimation of costs and the guide for bidding are included in the design documents according to contracts with the owner.

**Design Requirements (DR):** The DR detail the building type, the project risk, the conditions of use, and the criteria and acceptable performance of the building energy systems and indoor air quality. The CA develops the DR to harmonize with the budget and the performance of the project based on the OP.

**Fault Detection and Diagnostic Tool (FDD Tool):** The tool collects control information or other data and analyses them to detect symptoms of abnormal behavior in various HVAC components, such as uncalibrated or failed sensors, actuator or linkage failure, controller instability, non-optimal sequence of operations, etc. The tool also diagnoses their possible causes and provides explanations. It goes beyond the capabilities of conventional BEMS single-point alarms and integrates information from multiple sensors to establish a more comprehensive understanding of the status of operation. One could envision an FDD Tool or a set of tools that would monitor all systems at all times (24 hours a day, 365 days per year).

**Functional Performance Testing (FPT):** In the case of the systems having seasonal performance, such as HVAC systems, FPT should be continued for at least one year, and subsequently decide the initial performance of the system. For instance, FPT of the HVAC system means to verify that the equipment, subsystems and total system work in harmony (including stability and durability) to maintain the environment specified in the design documents within the predicted energy consumption. The FPT lays emphasis on the overall operation of the system, and should be differentiated from the TAB on the performance of the equipment itself. The CA may conduct the tests directly, or other members of the commissioning managing team may conduct them. These tests occur during the acceptance step of the construction phase.

**Guide for System Control and Operation:** Generally, it is not easy for the operating and maintenance personnel to understand the systems control and operation. The system diagrams, the lists of equipment and the explanations should be included in the guide. In case most of the contents are in the design intent documents, the design intent documents can be applied as the guide on the condition that explanations from the viewpoint of the operation and maintenance personnel are added to the design intent document.

**Owner's Program (OP):** The OP is a document written by the owner that describes the owner's overall vision and philosophy including environmental and energy objectives of the project. The OP outlines the project, the expectations for its use and operation, the baseline project budget, distribution of costs, and expected profitability. The different consultants may help the owner to develop the OP as necessary.

**Owner's Project Requirements (OPR):** The OPR is a document based on the OP and the DR. The owner develops it with help from the CA. The OPR should be completed during the pre-design phase. If the OP and the DR are satisfied fully, these documents can be filed together as the OPR.

**Preliminary Design Documents:** The preliminary design documents are developed by the design professional to confirm the basic design content before starting a working design. These documents include tables and layouts of equipment, schematics of duct and piping systems, a control system, basis of design, a draft design intent document and a commissioning specification based on the schematic planning documents. At the completion of preliminary design, all contents of the preliminary design documents should comply with related laws and regulations. The CA judges the appropriateness of the contents and organization written in the preliminary design documents; this judgment includes evaluation of whether they comply with the OPR, the design intent is appropriate, and the quality control of the design process is adequate.

**Preparation Procedure for Commissioning Starting at Construction Phase:** The preparation procedure for commissioning starting at construction phase is a preparatory procedure that should be performed when the Commissioning of the pre-design and design phases have not been implemented. The CA audits related documents (e.g. OPR and design documents, or resembling documents if insufficient), clarifies the possibility of Commissioning, and informs the owner if the design is incomplete. The owner and the design professional meet to resolve the problem. The role of CA at this meeting is to give the owner and the design professional unbiased advice based on professional knowledge to obtain the design characteristics and quality requested.

**Request for Proposal (RFP):** The RFP\_CA is a document written by the owner during the program step of pre-design phase to solicit a CA for the project. The owner requests proposals from prospective CAs for the Commissioning based on the document. The RFP\_Des is a document written by the owner with help from the CA to select a design professional for the project. The owner requests proposals from prospective design professionals for the design based on the document. The request document for a design competition is one kind of RFE\_Des used to select a design professional.

**Risk Evaluation (RE):** The process that identifies the risks related to an HVAC system that does not meet the OPR. It is an overall evaluation of qualitative and quantitative damage if the system does not meet the requirements. It considers the main human risks (e.g. responsibility, knowledge, consciousness, etc.) as well as the main system risks (e.g. risk management, time to discover and react in case of failure, time to get under control, trends, etc.) regarding the probability of its occurrence and the resulting damage (e.g. human health, environmental load, energy savings, cost, image, etc.). Risks can be classified in low, normal, and high categories. The risk is also addressed in the CxP by choosing the appropriate Commissioning level.

**Standard Models of Commissioning Plans (SMCxP):** The SMCxP were developed by Annex 40 to help understand the commissioning plan for non-residential buildings and to be applied as one of the commissioning tools. The five SMCxP models are based on the commissioning levels. The commissioning levels are defined based on the combination of the building size, the HVAC complexity and the risk level. In real projects, the SMCxP would be modified according to the project's characteristics and the social customs in each country and/or state.

**Schematic Planning Documents:** The schematic planning documents are documents presented to the owner by the design professional when the design professional begins a preliminary design. They include a design philosophy, environmental and energy criteria, functional requirements, environmental control requirements, and outlines of building systems that meet the OPR. If the design proposal made by the design professional is adequate, it can serve as the schematic planning documents. However, if the OPR and the commissioning plan are further developed, the schematic planning documents should be revised.

## C. Commissioning Types

**Initial Commissioning (I-Cx):** I-Cx is a systematic process applied to production of a new building and/or an installation of new systems that begins with the program step and ends with the post-acceptance step. In cases where new equipment is installed in an existing building (e.g., installing a cooling system in an existing building which previously had only a heating system), it should be referred to as I-Cx. Basically, the range of the commissioning process (CxP) implemented depends on the owner's desires and can be defined in a contract between the owner and a commissioning authority (CA). It is strongly recommended that consistency be maintained in the I-Cx process, but before commissioning becomes business-as-usual in a society, there will be cases where commissioning (Cx) in the pre-design and design phases have not been implemented as mentioned in the definition and explanation of 'Preparation Procedure for Commissioning Starting at Construction Phase'. In such cases, the I-Cx can be called 'Partial Initial Commissioning'.

**Retro-Commissioning (Retro-Cx):** Retro-Cx is the first time Commissioning is implemented in an existing building in which a documented CxP was not previously implemented. In many cases, design documents of the existing building have been lost or they don't match the current situation. Therefore, the Retro-Cx process may or may not include verification of the design shown in the I-Cx.

**Re-Commissioning (Re-Cx):** Re-Cx is a CxP implemented after the I-Cx or the Retro-Cx process when the owner hopes to verify, improve and document the performance of building systems. Reasons to re-commission a building are diverse. It could result from a modification in the user requirements, the discovery of poor system performance, the desire to fix faults found during the I-Cx, etc. Periodic Re-Cx ensures that the original performance persists. Re-Cx is the event that reapplies the original Commissioning in order to maintain the building systems' performance.

**On-Going Commissioning (On-Going Cx):** On-Going Cx is a CxP conducted continually for the purpose of maintaining, improving and optimizing the performance of building systems after I-Cx or Retro-Cx. The large difference between On-Going Cx and periodic Re-Cx is that the Re-Cx refers to the original building systems performance, while On-Going Cx lays emphasis on the performance optimization. The On-Going Cx is a successive CxP during the Operation & Maintenance Stage to resolve operational problems, improve comfort, optimize energy use, and recommend retrofits if necessary.

## D. Commissioning Process

**Pre-Design Phase:** The pre-design phase is the first phase of the I-Cx process, and is divided into two steps: 1) program step and 2) planning step. In the program step, the owner lays out the project concept as the OP. In the planning step, the owner develops the OPR with the CA. The role of the CA at this phase is to give the owner guidance in drawing up the OPR, and to develop the commissioning plan based on it.

- 1) **Program Step:** In the program step, the owner's philosophy on the building environment and performance is established as the OP. The OP includes the outline and profitability of the project and the concept describes the energy conservation and urban/global environmental impact mitigation. The owner makes a RFP\_CA, and solicits a CA. In this step, the owner can ask for inside and/or outside professionals on technology, finance, business and construction.
- 2) **Planning Step:** In the planning step, the CA makes the DR, and the owner makes the OPR so that a design professional can propose a concrete design. The OPR is developed based on the OP and the DR. The owner releases an RFP for a design professional, and then selects a design professional for the project. Generally, the milestone between the program step and the planning step is when the CA joins the project. The CA develops a commissioning plan, and helps the owner or acts for the owner if necessary to develop the OPR and the RFP\_Des and selection criteria of design professional. In this step, the CA considers opinions of the construction manager, facility manager, financial advisor, operation and maintenance staff, occupants, etc., and identifies systems targeted for Commissioning and documents them. At the same time, the CA helps the owner to estimate costs for design, construction, TAB, consultants, etc. and investigates laws and regulations relating to the Commissioning. The scope of the work in this step varies widely depending on the project size and owner's requirements for Commissioning, but the tasks explained above are key points for a successful CxP.

**Design Phase:** The design phase begins with drafting schematic planning documents and ends with completion of design documents and their handover to the owner. the design professional is selected during the planning step and, depending on the contract, may have the responsibility to make a costs/amounts document based on the design documents, present the design works on site, make a questions/answers document, etc. The design phase is divided into two steps, which are 1) preliminary design step and 2) working design step.

- 1) **Preliminary Design Step:** The preliminary design step begins with making the schematic planning documents and ends with completion of the preliminary design documents. The milestone for the end of this step is submission of the preliminary design documents. All contents of the documents must comply with laws and regulations on the building systems. The CA verifies the appropriateness of the schematic planning documents and the preliminary design documents, clarifies the procedure and schedule of Commissioning, and reviews the commissioning plan again to coordinate with the design intent so that the design professional can clearly write the commissioning specification in the design documents.

- 2) **Working Design Step:** During the working design step, the preliminary design documents are further developed into the final design documents. The design professional updates the draft design intent document included in the preliminary design documents, and completes the final design documents based on it. The CA audits the accuracy of the contents of the documents and verifies that the contents are complete. The details of the design work, reviews, and the quality and schedule control are the responsibility of the design professional, but if there are any deficiencies or inconsistencies with the OPR, the CA should point them out directly to the design professional or indirectly through the owner depending on the situation and should instruct their correction based on the owner's decisions.

**Elaboration Phase (Elaboration Step):** The Elaboration Phase is a transitional phase between the completion of design work and the start of construction. During this phase, the completion of the construction documents, bid submission, bid assessment and selection of the contractor for the construction are performed. The leading person in this phase is of course the owner or the project manager/construction manager acting for the owner. In cases of private construction, the Design Professional may participate in this work. The role of the CA is to help the commissioning related parties so that the information on the assigned work and the responsibility for the Commissioning is well shared among the bidding companies. In cases where Commissioning starts without implementing the pre-design phase and design phase, the preparation procedure for commissioning starting at construction phase that shall be taken for the post facto CxP may be assigned to this phase.

**Construction Phase:** The construction phase is divided into two steps, 1) construction step and 2) acceptance step. In the construction step, contracting is based on the design documents, and the construction of building systems is started and completed under supervision. Appropriate TAB tasks are also implemented by the contractor. In the acceptance step, FPT is completed under the direction of the CA based on the results of the TAB tasks, and then the building systems are handed over to the owner. The role of the CA is to cope with design changes and to verify the appropriateness of construction supervision and construction control, to inspect TAB performed, to implement FPT, and to plan and implement a schedule of education and training for operation and maintenance personnel.

- 1) **Construction Step:** The contractor makes shop drawings based on the design documents, controls schedule and quality of the construction under the instruction of the construction supervisor, installs ducts, pipes, wires and equipment, and implements TAB work. The role of the CA during this step is to correctly convey changes of OPR to the commissioning related parties or propose design changes to the owner through the construction supervisor, and to advise them on their necessity and the possibility/contribution toward achieving requested performance. The CA also audits performance of the construction supervision and control, supervises the TAB work, and confirms the maintainability of building systems with the owner or on behalf of the owner.

- 2) **Acceptance Step:** The Acceptance Step is the final step before the building systems are handed over to the owner. The contractor finishes the TAB work on equipment and systems including Building and Energy Management System (BEMS), and completes the as-built records and system operation and maintenance manual. The CA verifies that the TAB work is correctly implemented and that the as-built records are documented fully and correctly. These results are documented by the CA and the document is presented to the contractor as a certificate of readiness. The CA also determines from FPT results if the equipment and systems work and meet the OPR. the design professional and/or the contractor are requested to solve any faults revealed at this step and to properly readjust the systems as quickly as possible. The CA plans the education and training program, and manages it so that the operation and maintenance personnel can completely understand the system manual summarized by the CA. If the CA judges the construction inappropriate and the remaining time for the adjustments before occupancy is insufficient, the CA makes the list of faults to be addressed by the design professional, the contractor and/or the manufacturer, and suggests to the owner that these faults should be corrected during the subsequent Commissioning of the occupancy & operation phase.

**Occupancy & Operation Phase:** The occupancy & operation phase is the phase after building systems are completed and handed over to the owner. the occupancy & operation phase is divided into two steps: the 1) post-acceptance step and 2) ordinary operation step. In this phase, the FPT of building systems has already completed, the building systems are operating properly, and the operation and maintenance personnel have been educated and trained. However, in case of systems that need seasonal Commissioning such as an air-conditioning system, the initial performance of the systems is decided by FPT conducted over at least one year following completion of building systems. the post-acceptance step can be applied in that case. the ordinary operation step continues after the post-acceptance step. The I-Cx process begins with the program step and ends with the post-acceptance step. If the systems commissioned do not have seasonal changes of the performance, the post-acceptance step is skipped.

- 1) **Post-Acceptance Step:** The post-acceptance step is applied to building systems in which the performance is seasonally changed and the DR demands confirmation of the annual performance such as an air-conditioning system. This post-acceptance step is the final step of I-Cx process. The role of the CA in this step is to identify the seasonal system performance. For example, in the case of an air conditioning system, determine the system performance for the peak-cooling season, the peak-heating season, and the intermediate season when cooling and heating modes are both required. Commissioning during the post-acceptance step includes the seasonal FPT, and the annual performance evaluation and stability of automatic control response, which would be implemented using BEMS in most cases. The faults that were identified in the Acceptance Step to be addressed during this phase should be corrected and readjusted as soon as possible. All of the I-Cx is completed when this step is finished. The CA makes a commissioning process report and submits it to the owner. The term of the post-acceptance step mostly overlaps with the warranty term of the construction, and the seasonal FPT mentioned above is considered to be requested in the range of the construction.



There could be cases where the final payment for a project is postponed until one year after occupation, but the milestone between the acceptance and post-acceptance steps is guided by this explanation.

- 2) **Ordinary Operation Step:** The ordinary operation step is defined as the step following the post-acceptance step of I-Cx. If the I-Cx itself or the post-acceptance step is not applied, this step would be matched with the occupancy & operation phase. In this step, the evaluation work for the Re-Cx and/or On-Going Cx to identify the unresolved issues, desired changes, weaknesses identified during Commissioning, desirable improvements identified during Commissioning, warranty action items, etc., may be addressed. The repeated Re-Cx could correct faults, and the evolution to the On-Going Cx may maintain the building systems in optimal condition through life of the building.





## **APPENDIX 2: POSTERS OF THE DEMONSTRATION SITES**

*The posters of the demonstration sites are not included in the electronic version of the final report. They are available in the poster directory (a pdf file by poster).*

*On the following page, you will find the list of the demonstration sites.*

## **Belgium**

B1: CA-MET headquarters of the Ministry of Equipment and Transport

## **Canada**

C1: CANMET Energy Technology Centre

## **Germany**

D1: GMS

D2: BSZ

D3: Munchener Ruckversicherung

## **France**

FR1: Nursery school of Crevecoeur Legrand

FR2: Aria, Research building of CSTB

FR3: PB6 headquarters of EDF

FR4: Schools of the town of Paris

FR5: University Rhone-Alpes

## **Finland**

FI1: Dynamo building of Jyväskylä Polytechnic

FI2: Digital building

## **Hungary**

HU1: Cultural Palace

HU2: NH Eurobuilding Hotel (Spain)

## **Japan**

JP1: K Building

JP2: Shinkawa building

JP3: Tepco Building

JP4: Yamatake research centre

JP5: O House, residential building

## **The Netherlands**

NL1: Postbank office building

## **Norway**

NO1: Primary school of Trondheim

## **Sweden**

SW1: KV Valten

SW2: KV Katsan

SW3: Kista Entré

## **Switzerland**

CH1: Swiss federal institute for forest, snow and landscape

CH2: Wankdorf Bern New stadium and commercial centre

## **USA**





US1: Government office building of the City of Oakland

## DEMONSTRATION SITE: CA-MET BUILDING BELGIUM

### Description of building: headquarters of the Ministry of Equipment and Transport

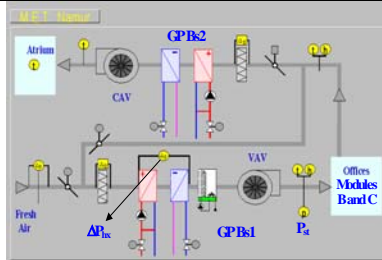
	☞ Location: Namur – Belgium
	☞ Type of building: Office building
	☞ Year of construction: 1997-2000
	☞ Size: 15 000 m <sup>2</sup> (gross floor area)
	☞ Contacts: <ul style="list-style-type: none"> <li>• J Lebrun : <a href="mailto:j.lebrun@ulg.ac.be">j.lebrun@ulg.ac.be</a></li> <li>• Ph. André : <a href="mailto:p.andre@ulg.ac.be">p.andre@ulg.ac.be</a></li> </ul>

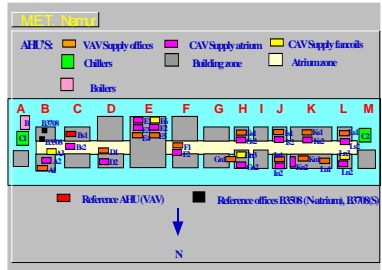
### Description of HVAC system

		<p><b>Plant level</b></p> <ul style="list-style-type: none"> <li>• 2 chiller: 2 x 900 kW</li> <li>• 3 gas boilers: 3 X 900 kW</li> <li>• 10 Air Handling Units, Constant Air Volume (CAV) supplying atrium</li> <li>• 12 Air handling Units, Variable Air volume, supplying offices</li> </ul> <p><b>Zone level</b></p> <ul style="list-style-type: none"> <li>• Radiators (offices)</li> <li>• VAV boxes (offices)</li> <li>• Fan Coil Units (meeting rooms)</li> </ul> <p><b>BEMS system</b></p> <ul style="list-style-type: none"> <li>• Brand: Honeywell :</li> <li>• Size: 200 points</li> <li>• Local controller: Honeywell Excell</li> <li>• Supervisor: Building Supervisor</li> </ul>
		

### Commissioning project

<p><b>Objectives:</b></p>	<p><b>Solve occupant complaints concerning thermal comfort</b></p> <ul style="list-style-type: none"> <li>• Evaluation of the ventilation system performance</li> <li>• Improvement of the facility manager knowledge on the HVAC operating</li> <li>• Help manager to satisfy cooling demand</li> </ul>
<p><b>Type of Commissioning:</b></p>	<ul style="list-style-type: none"> <li>• Re Commissioning</li> </ul>
<p><b>Phases concerned:</b></p>	<ul style="list-style-type: none"> <li>• Operating phase</li> </ul>
<p><b>Target users:</b></p>	<ul style="list-style-type: none"> <li>• Building owner, Facility manager</li> </ul>

## Tools and methods developed

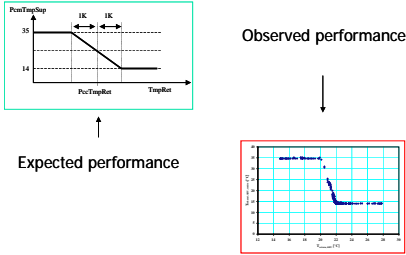
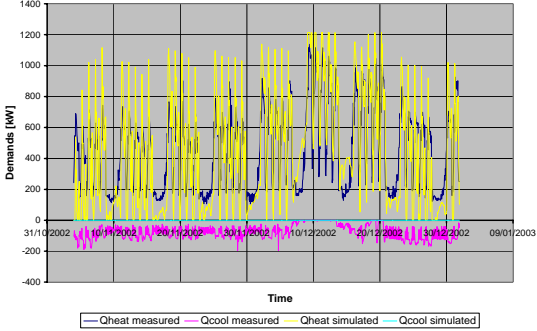
<p><b>Manual tools</b></p> 	<p><b>FTP for manual Cx of Air Handling Units</b></p> <p>For example, to test the “Return Air Temperature Sensor” the user must answer the following questions:</p> <ol style="list-style-type: none"> <li>1. Is the sensor really available?</li> <li>2. Is the sensor placement optimal for measuring the physical phenomena?</li> <li>3. Is the sensor correctly connected to the control equipment (wiring)?</li> <li>4. Is the sensor measurement consistent with reference values?</li> </ol>
<p><b>Manual Tools</b></p> 	<p><b>FTP for manual Cx of building demands</b></p> <p>Calibrated simulation to analyse building demands (heating, cooling, electricity)</p> <ul style="list-style-type: none"> <li>• Simulation of the building for typical periods</li> <li>• Calibration of the simulation model on that period</li> <li>• Extrapolation to yearly demands</li> <li>• Comparison of measured consumptions to simulation calculated baseline</li> <li>• This method currently works off-line</li> </ul>

## Practical experiences

### Users interview

Occupants Interview	Operator Interview
<ul style="list-style-type: none"> <li>• Some offices are too hot in mid-season and summer period</li> <li>• Some VAV boxes are too noisy</li> <li>• Some occupants suffer from cold drafts</li> </ul>	<ul style="list-style-type: none"> <li>• Operator is still a “transition” operator before official long term contract</li> <li>• Operator try to solve most urgent problems</li> <li>• As-built document not comprehensive</li> <li>• A lot of installation problems</li> </ul>

### Cx actions

- Occupant and operator interviews
- Design review, collect and check of the available documents
- Installation review and verification of the sensors and actuators
- Execution of the verification procedure
  - Active and Passive testing of AHUs and its control system
  - Analysis of the heating and cooling demands
- Documenting: test results, performance of AHUs

### Cx Recommendations



Manual	0	Specifications Review	Add commissioning-related items to specifications
	1	Design Review	Check control logic, sensor placement and sensor accuracy with design documents
	2	Installation Review and Verification	Conduct a field inspection to determine installed characteristics of the equipment including condition and sensor availability (real location)
BEMS assisted	3	Installation Review and Verification with BEMS	Verify mismatch between BEMS control logic and design documents
	4	Measurement Verification with BEMS	Define measurements to log with BEMS, evaluate data for compliance
	5	Forced Response Testing and Analysis	Analyse performance of the system with the testing procedures.
	6	Documentation	Document the result of the commissioning analysis

## DEMONSTRATION SITE: CANMET ENERGY TECHNOLOGY CENTER- VARENNES, CANADA

### Description of building: Technology development Center

	☞ Location: Varennes, Québec, Canada
	☞ Type of building: Office and laboratory building
	☞ Year of construction: 1992
	☞ Size: 3600 m <sup>2</sup> (conditioned floor and heated floor)
	☞ Contact: <ul style="list-style-type: none"> <li>D Choiniere : <a href="mailto:dchoinie@nrcan.gc.ca">dchoinie@nrcan.gc.ca</a></li> </ul>

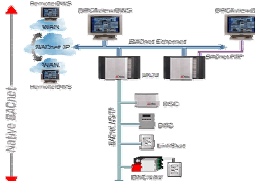
### Description of HVAC system

   	<p><b>Plant level</b></p> <ul style="list-style-type: none"> <li>Cooling Plant <ul style="list-style-type: none"> <li>☞ 1 chiller: 406 kW</li> <li>☞ ice storage tank: 1145 kw/hr</li> <li>☞ 1 constant water flow zone</li> </ul> </li> <li>Heating plant: <ul style="list-style-type: none"> <li>☞ 2 gas boilers: 2 X 470 kW</li> <li>☞ 5 variable water flow zones</li> </ul> </li> <li>6 Air Handling Units, Constant Air Volume (CAV)</li> <li>3 Air Handling Units, Variable Air Volume (VAV)</li> <li>Total AHU air volume: 24,000 l/s</li> </ul> <p><b>Zone level</b></p> <ul style="list-style-type: none"> <li>Variable air volume terminal devices and perimeter radiators (offices)</li> <li>Variable air volume terminal devices with reheat coils (laboratories)</li> </ul> <p><b>BEMS system</b></p> <ul style="list-style-type: none"> <li>Brand: Delta Controls</li> <li>Size: 900 points</li> <li>Control protocol: BACnet</li> <li>Supervisor: Orca</li> </ul>
---	---

### Commissioning project

<b>Objectives:</b>	<p><b>Optimize Building Energy Performance and comfort</b></p> <ul style="list-style-type: none"> <li>Improve HVAC performance and comfort</li> <li>Improve the facility manager's knowledge of the HVAC operating</li> <li>Testing, Adjusting and Balancing of the control systems</li> </ul>
<b>Type of Commissioning:</b>	<ul style="list-style-type: none"> <li>Re Commissioning and On-going Commissioning</li> </ul>
<b>Phases concerned:</b>	<ul style="list-style-type: none"> <li>Occupancy and Operating phase, Construction phase</li> </ul>
<b>Target users:</b>	<ul style="list-style-type: none"> <li>Building operator, facility manager, commissioning agent, service company</li> </ul>

## Tools and methods developed

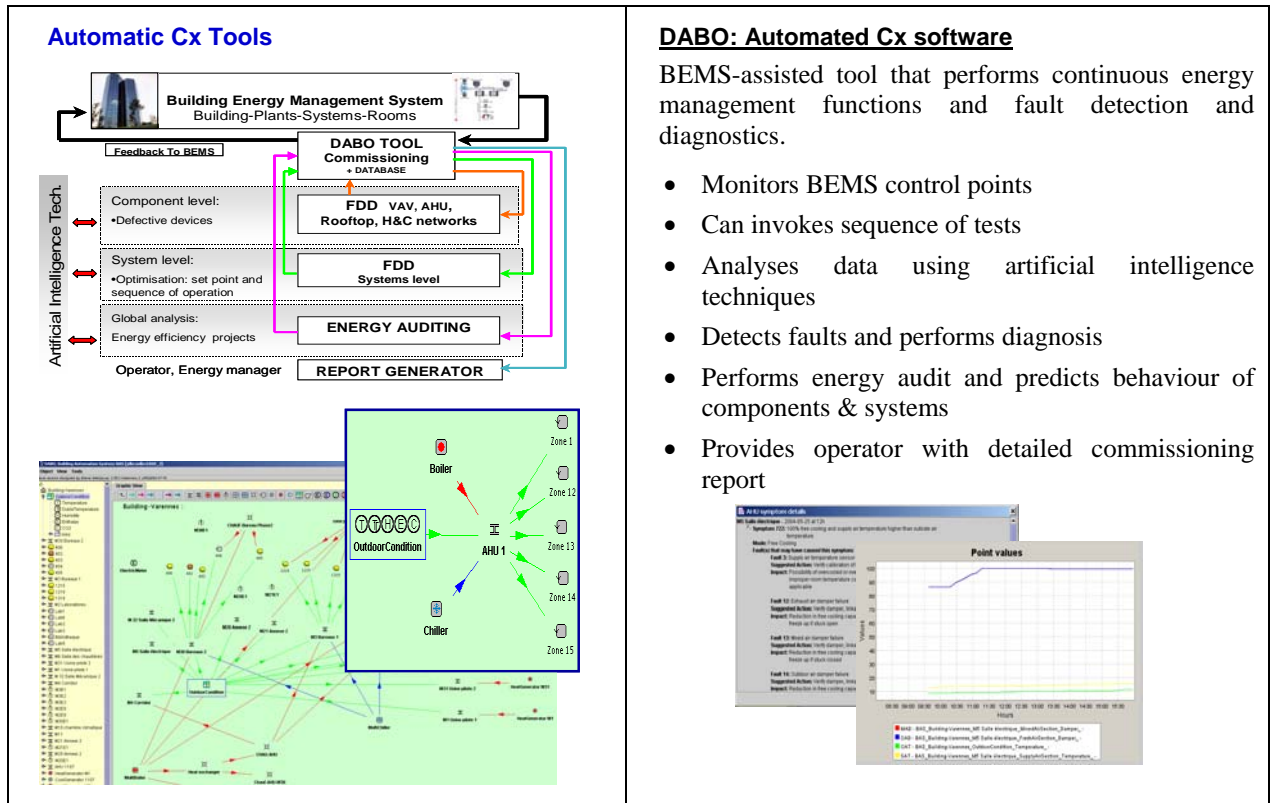

## Practical experiences

### Cx process

- On-going commissioning gradually implemented since 1998
- Data acquisition and monitoring – 1998
- Manual analysis of BEMS data
- BEMS assisted FDD and Cx tool for AHU and VAV Boxes:
  - gradually implemented since 2000
- Implementation of measures function of funding availability
- On-going FDD and Cx since 2002

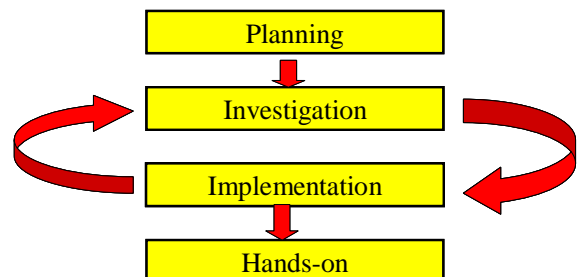

### Cx Action

- Reset operation schedules (AHU, hydronic circuits)
- Optimized controls and sequence of operation
  - Function of actual needs
  - Peak load management (Chiller, humidification)
  - Avoid simultaneous heating and cooling
- Reset setpoints : (AHU, hydronic circuits)
  - Minimum fresh air
  - Supply pressure and temperature
  - Night set back
- Fixed minor deficiencies
  - Sensor calibration
  - Low heating capacity in some rooms
  - Replacement of leaking valves
- Implemented low payback investments
  - Addition of DDC controls (chiller, boiler 2001)
  - Link AHU M2 to solar wall (2003)
  - VSD on 3 fans (2002)
- Implemented a continuous energy management plan

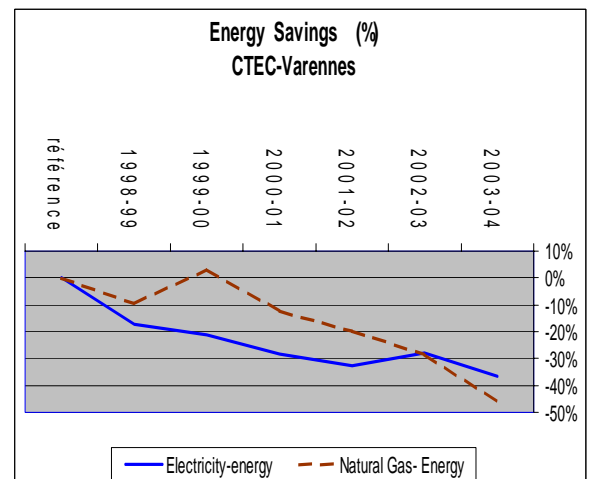



# DEMONSTRATION SITE: SWISS FEDERAL INSTITUTE FOR FOREST, SNOW AND LANDSCAPE

## Description of building: Research laboratory building

	☞ Location: Birmensdorf, Switzerland
	☞ Type of building: Laboratory and Office building
	☞ Year of construction: 1986
	☞ Size: 5 floors, 3'675 m2
	☞ Contact: <ul style="list-style-type: none"> <li>J.M. Chuard: <a href="mailto:chuard@enerconom.ch">chuard@enerconom.ch</a></li> </ul>

## Description of HVAC system

	<p>HVAC: 2 AHU-units, for each side of the building (north/south) with fixed room based air distribution in offices and in lab space. AHU units with heat recovery heat exchanger. Total AHU air volume: 10'000 m3/h</p> <p>Central flow box exhaust for the lab space, ventilation: room based exhaust system, mainly through flow boxes only. Minimum exhaust volume of 20% for each flow box when ventilation is turned off. Exhaust ventilator without heat exchange system. Total exhaust air volume: Ø 15'000 m3/h</p> <p>No central BEMS building control system. Fixed rates for On/Off in each lab room. Pressure controlled, variable volume in the central AHU-distribution and in the central exhaust systems.</p>
--	--

## Commissioning project

<b>Objectives:</b>	<ul style="list-style-type: none"> <li>Achieve a proper ventilation operation with appropriate room climate (vent. efficiency, vent. rates, etc.)</li> <li>Realisation of existing potential in energy savings</li> </ul>
<b>Type of Commissioning:</b>	<ul style="list-style-type: none"> <li>Re-Commissioning</li> </ul>
<b>Phases concerned:</b>	<ul style="list-style-type: none"> <li>Occupancy and operating phase</li> </ul>
<b>Target users:</b>	<ul style="list-style-type: none"> <li>Building owners</li> </ul>

## Tools and methods developed

<p><b>Manual tools</b></p>	<p><b><u>Test procedure</u></b></p> <ul style="list-style-type: none"> <li>• Simple system check procedure and calculation of savings for the decision process of the owners</li> <li>• Simple system check and acceptance check after realisation and balancing the new system, using SWKI check lists</li> </ul>
----------------------------	--

## Practical experiences

### *Users interview*

Occupant Interview	Operator Interview
<ul style="list-style-type: none"> <li>• Laboratory specifications for air quality and indoor temperature are not met</li> <li>• Offices and the laboratory space have massive draught</li> </ul>	<ul style="list-style-type: none"> <li>• In many flow boxes the system is not operating properly</li> <li>• The air balance in the building is not correct</li> <li>• Energy consumption in this building far above the average of the institute.</li> </ul>

### **Cx actions**

- Function tests, checks of the regulation and checks of the exhaust air flow and pressure on a sample of flow boxes
- Function tests, checks of the regulation and checks of the local fresh air flow and pressure on a sample of flow boxes
- System Check and measures of the air flow on the 2 AHU-units
- System Check and measure of the air flow an the central exhaust ventilator for lab space
- Analyse the malfunctions of the system and its components. Definition of the actions to be taken, such as:
  - replace all air valves and their regulations in the offices and in the lab space
  - add a heat exchange equipment between central exhaust ventilator and both AHU-units
  - balance the systems
- Complete Cx test at the end of the realisation, using the SWKI-check lists.

### **Cx Recommendations**

Manual	1	Measurement verification	Check first a sample of the components in field inspection. Analyse the malfunctions. If the failure is systematic, generalise the result, but consider the risk.
	2	Balancing the systems	Do not check only the air flow balance of the AHU system, but check also the over all building air flow balance. You can not establish a realistic balance for a new system without a detailed list of the all system requirements.



## DEMONSTRATION SITE: STADE DE SUISSE, WANKDORF IN BERN

### Description of building: New stadium and commercial centre

	☞ Location: Bern, Switzerland
	☞ Type of building: Commercial centre and offices
	☞ Year of construction: 2004/2005
	☞ Size: 8 floors, total of 55'000 m2 / shopping centre: 30'000 m2
	☞ Contacts: <ul style="list-style-type: none"> <li>• J.M. Chuard: <a href="mailto:chuard@enerconom.ch">chuard@enerconom.ch</a></li> </ul>

### Description of HVAC system

	<ul style="list-style-type: none"> <li>• HVAC: 12 AHU-units with a total volume of 160'500 m3/h; each unit designed for its specific application; claim to minimise the energy consumption in operation.</li> <li>• Basic concept of heat recovery systems with a calculated average efficiency of <math>\geq 70\%</math>; system optimisation process leads to an average efficiency of <math>\geq 81\%</math> and a reduction of the electrical energy consumption of the AHU units of 166 MWh/a.</li> <li>• Variable air volume distribution system, no additional heating or cooling; Central gas boiler and central chiller for the whole complex Hot and chilled water distribution, low temperature heat recovery distribution system</li> <li>• BEMS system for heating, cooling, ventilation, electric lighting Blinds with master control and monitoring Room control for ventilation Central temperature control for building Central energy management system.</li> </ul>
--	---

### Commissioning project

<b>Objectives:</b>	<ul style="list-style-type: none"> <li>• Achieve a proper building operation with minimised operation costs</li> <li>• Work out guidelines for building operation.</li> </ul>
<b>Type of Commissioning:</b>	<ul style="list-style-type: none"> <li>• Initial-Commissioning</li> </ul>
<b>Phases concerned:</b>	<ul style="list-style-type: none"> <li>• Design phase</li> </ul>
<b>Target users:</b>	<ul style="list-style-type: none"> <li>• Building owners, resp. Facility Managers</li> </ul>

## Tools and methods developed

<p><b>Manual tools</b></p>	<p><b><u>Guidelines for check procedure in design phase</u></b></p> <ul style="list-style-type: none"> <li>• Check in detail the designed performance of all HVAC systems with the OPR.</li> <li>• Check in detail the tenants specifications of his equipment with the accepted design specification of the designer (e.g. balance between designed maximum cooling load and effective load according to the tenants designer specification; ---&gt; bottem up check)</li> </ul>
----------------------------	---

## Practical experiences

### *Design phase interview*

<p><b>Tenant Interview (of commercial spaces)</b></p>	<p><b>Designer Interview</b></p>
<ul style="list-style-type: none"> <li>• The effective load of cooling needs in the tenants space is not known or underestimated</li> </ul>	<ul style="list-style-type: none"> <li>• The power of the cooling supply is designed according to the OPR. The OPR definition is based on a average admittance of the needs of cooling in W/m2 over the whole commercial space.</li> </ul>

### **Cx actions**

- Establish a bottom up balance of all needs (electrical power, heating and cooling supply)
- Check the balance between designed supply power and detected needs
- Check the HVAC systems with SWKI check lists

### **Cx Recommendations**





<p>Manual</p>	<p>1</p>	<p>Design power supply</p>	<p>Check the plausibility of the designed electrical power, heating and cooling supply before the end of realisation.</p>
---------------	----------	----------------------------	---

## DEMONSTRATION SITE: GEBHARD-MÜLLER-SCHOOL BIBERACH, GERMANY

### Description of building: Gebhard-Müller-School, vocational school building

	☞ Location: Biberach, Germany
	☞ Type of building: School building
	☞ Year of construction: 2002 - 2004
	☞ Size: 3 storeys, 10000 m <sup>2</sup> (conditioned floor area)
	☞ Contact: Oliver Baumann, Ebert-Ingenieure München <a href="mailto:o.baumann@ebert-ing-muenchen.de">o.baumann@ebert-ing-muenchen.de</a>

### Description of HVAC system

		<p><b>Plant level</b></p> <ul style="list-style-type: none"> <li>• 2 heat pumps: 2 x 110 kW (ground water)</li> <li>• 1 wood fired furnace: 120 kW</li> <li>• 3 air handling units with <ul style="list-style-type: none"> <li>- variable air volume (VAV)</li> <li>- heating and cooling coils</li> <li>- rotary heat exchanger</li> </ul> </li> </ul> <p><b>Zone level</b></p> <ul style="list-style-type: none"> <li>• heating and cooling with embedded heating and cooling coils in concrete slabs</li> <li>• mechanical ventilation with variable air volume rates</li> <li>• modular room concept for highest flexibility and easy to handle modifications</li> </ul> <p><b>BEMS system</b></p> <ul style="list-style-type: none"> <li>• Central building automation system (BAS) for heating, cooling, ventilation, electric lighting and shading system</li> <li>• Size: about 2000 data points</li> </ul>
		

### Commissioning project

<b>Objectives:</b>	<p><b>Low energy building</b></p> <ul style="list-style-type: none"> <li>• high thermal comfort and low energy consumption <ul style="list-style-type: none"> <li>- less than 25 kWh/m<sup>2</sup>a for heating,</li> <li>- less than 100 kWh/m<sup>2</sup>a for primary energy</li> </ul> </li> <li>• design of integrated systems for heating, cooling and ventilation</li> <li>• estimation of exact settings for the control systems already during the design process</li> <li>• minimum effort for testing and balancing on site</li> </ul>
<b>Type of Commissioning:</b>	<ul style="list-style-type: none"> <li>• Initial Commissioning</li> </ul>
<b>Phases concerned:</b>	<ul style="list-style-type: none"> <li>• concept, design, construction, hand over, operation</li> </ul>
<b>Target users:</b>	<ul style="list-style-type: none"> <li>• Facility manager, operation personnel</li> </ul>

## Tools and methods applied

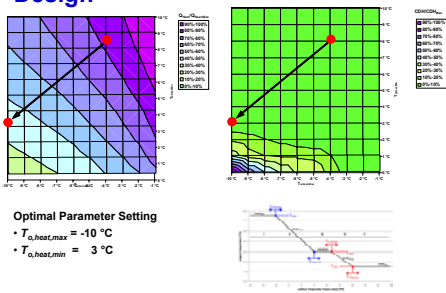
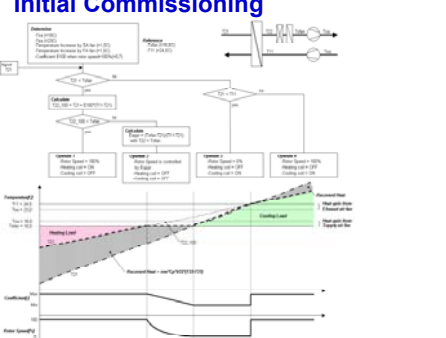
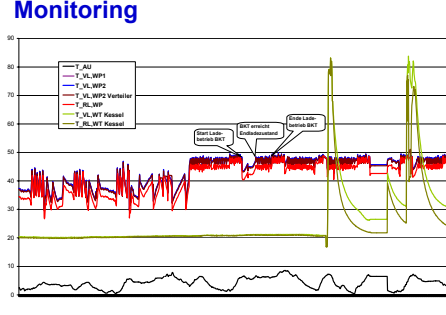
<p><b>Design</b></p>  <p><b>Optimal Parameter Setting</b></p> <ul style="list-style-type: none"> <li>• <math>t_{o,heat,max} = -10\text{ °C}</math></li> <li>• <math>t_{o,heat,min} = 3\text{ °C}</math></li> </ul>	<p><b>Simulation Models</b></p> <p>The control strategy for the embedded heating and cooling system was optimized using dynamic building and system simulation. Even optimal control settings have been estimated using simulation models on the whole building level, as well as the system level. An energy saving potential of about 35 % was estimated without any negative effect to the thermal comfort.</p>
<p><b>Initial Commissioning</b></p> 	<p><b>Functional Performance Tests</b></p> <p>Functional Performance Tests (FPT's using models) have been developed for crucial systems and components for the energy efficiency that have been identified during design and construction of the building:</p> <ol style="list-style-type: none"> <li>1. Air handling units (AHU's) with rotary heat exchangers</li> <li>2. heat pump systems, including ground water pump and wood fired furnace as peak load system</li> </ol>
<p><b>Monitoring</b></p> 	<p><b>Data Visualization</b></p> <p>As a demonstration site for a research project, the building will be monitored for two years after completion. Therefore, the data visualization tool <i>Pia</i> will be used to display the data that is recorded in the BAS. Additional sensors and meters have been installed to get detailed energy balances for each system. The monitoring will be performed by the University of Applied Sciences in Biberach.</p>

## Practical experiences

### User's comments

- high satisfaction with thermal comfort from first day on
- high acceptance of building and systems due to only minor problems
- incorporation of user and operation personnel in the design process with numerous explanations, instructions and training in advance is seen as very positive;

### Manufacturer's comments

- supplier for BAS did not understand all of the design intention
- particularly innovative and advanced control strategies need to be better documented, communicated, and explained

## DEMONSTRATION SITE: BERUFSSCHULZENTRUM BITTERFELD, GERMANY

### Description of building: BSZ Bitterfeld, vocational school building



- ☞ Location: Bitterfeld, Germany
- ☞ Type of building: School building
- ☞ Year of construction: 1998 - 2000
- ☞ Size: 3 storeys, 25000 m<sup>2</sup> (conditioned floor area)
- ☞ Contact:  
Oliver Baumann, Ebert-Ingenieure München  
[o.baumann@ebert-ing-muenchen.de](mailto:o.baumann@ebert-ing-muenchen.de)

### Description of HVAC system

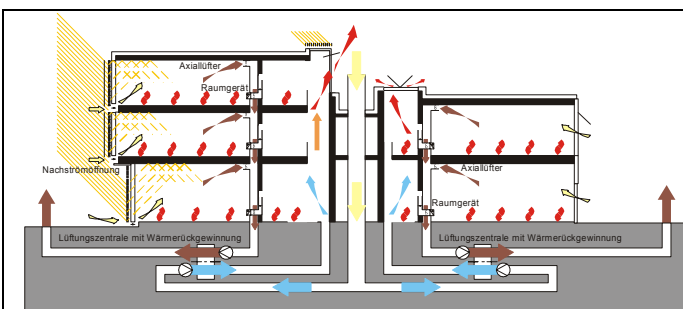

#### Building level

- building designed for maximum use of solar gains and minimum heat losses through walls, windows and ceilings

#### Plant level

- district heating
- underground air ducts (100 m length) to pre-condition (heating in winter, cooling in summer) outdoor air using geothermal energy
- air handling units (AHU's) with high efficient heat recovery

#### Zone level

- ventilation with two-stage fan in each classroom
- no additional heating in classrooms

#### BEMS system



- Central building automation system (BAS) for heating, cooling, ventilation, and shading system
- Size: about 3200 data points

### Commissioning project

<b>Objectives:</b>	<b>Low energy building</b> <ul style="list-style-type: none"> <li>• high thermal comfort and low energy consumption - less than 45 kWh/m<sup>2</sup>a for heating</li> <li>• design of integrated systems for heating, cooling and ventilation</li> </ul>
<b>Type of Commissioning:</b>	<ul style="list-style-type: none"> <li>• Initial Commissioning / Retro Commissioning</li> </ul>
<b>Phases concerned:</b>	<ul style="list-style-type: none"> <li>• operation</li> </ul>
<b>Target users:</b>	<ul style="list-style-type: none"> <li>• user, facility manager, operation personnel</li> </ul>

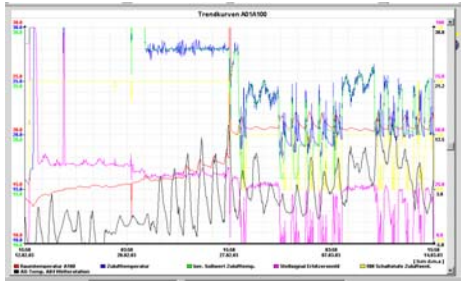

## Tools and methods applied

<p><b>Building level</b></p> 	<p><b><u>Check Performance of Building Envelope</u></b></p> <p>As an important part of the low energy concept, the building envelope was tested for air tightness and insufficient insulation (cold bridges). Infrared fotos showed leakages at windows and louvers in facades that caused infiltration and uncontrolled heat losses in classrooms.</p>
<p><b>System level</b></p> 	<p><b><u>Check Dynamic Operation</u></b></p> <p>The operation of building and systems was checked via remote access to the BEMS. The analysis of recorded data proved that the operation and control strategies were not implemented correctly. Even major failures like outages of the district heating were not recognized.</p>
<p><b>Zone level</b></p> 	<p><b><u>Measurements in Rooms</u></b></p> <p>To analyse the reason for missing thermal comfort, different measurements were performed in exemplary class rooms:</p> <ol style="list-style-type: none"> <li>1. Smoke tests were performed to analyze the air flow in classrooms and to proof the results of CFD simulations. The simulations furnished optimal air flow rates and supply air temperatures how to operate the rooms under different conditions</li> <li>2. Additional sensors have been installed to measure temperatures at different points in the classrooms.</li> </ol>

## Practical experiences

### ***User's comments***

- the thermal comfort was criticized even after two years of operation
- the energy consumption was much higher than expected
- since the innovative building concept was not communicated to the users, it was not understood and accepted
- the operation personnel was not able to manage the occurring problems after hand over and often took wrong measures to 'fix problems'

### ***Lessons learned***



- the design intention was not adequate documented and communicated to users, operation personnel or BAS supplier
- particularly innovative and advanced control strategies need to be better documented, communicated, and explained
- there was no initial commissioning and therefore no proper operation of building and systems

## DEMONSTRATION SITE: MÜNCHENER RÜCKVERSICHERUNG, GERMANY

### Description of building: Ostgebäude Münchener Rückversicherung, office building

	☞ Location: Munich, Germany
	☞ Type of building: Office Building
	☞ Year of construction: 1965, renovation in 1997
	☞ Size: 4 floors, 9000 m <sup>2</sup> (conditioned floor area)
	☞ Contact: Oliver Baumann, Ebert-Ingenieure München <a href="mailto:o.baumann@ebert-ing-muenchen.de">o.baumann@ebert-ing-muenchen.de</a>

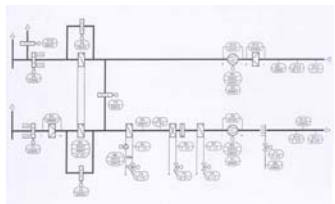
### Description of HVAC system

	<p><b>Plant level</b></p> <ul style="list-style-type: none"> <li>• District heating</li> <li>• Chiller plant with cooling towers</li> <li>• several Air Handling Units with             <ul style="list-style-type: none"> <li>- Variable Air Volume (VAV)</li> <li>- heating and cooling coils</li> <li>- humidification and dehumidification</li> <li>- heat recovery</li> </ul> </li> </ul>
	<p><b>Zone level</b></p> <ul style="list-style-type: none"> <li>• radiators for heating</li> <li>• cooling panels in office rooms</li> <li>• mechanical ventilation with variable air volume rates</li> </ul>
	<p><b>BEMS system</b></p> <ul style="list-style-type: none"> <li>• Central building automation system (BAS) for heating, cooling, ventilation, electric lighting and shading system</li> <li>• Size: about 3200 data points</li> </ul>

### Commissioning project

<b>Objectives:</b>	<ul style="list-style-type: none"> <li>• The objective is to show optimization potential at a standard office building</li> <li>• Energy savings will be verified by a detailed metering concept, performed by 'Forschungsstelle für Energiewirtschaft' (FfE)</li> </ul>
<b>Type of Commissioning:</b>	<ul style="list-style-type: none"> <li>• Re-Commissioning / Operation Diagnostics</li> </ul>
<b>Phases concerned:</b>	<ul style="list-style-type: none"> <li>• Operation</li> </ul>
<b>Target users:</b>	<ul style="list-style-type: none"> <li>• Facility manager, operation personnel</li> </ul>

## Tools and methods applied

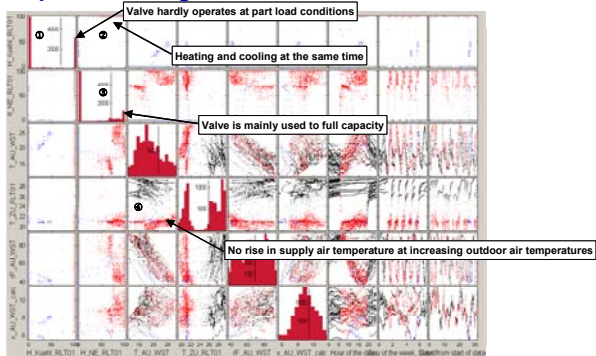
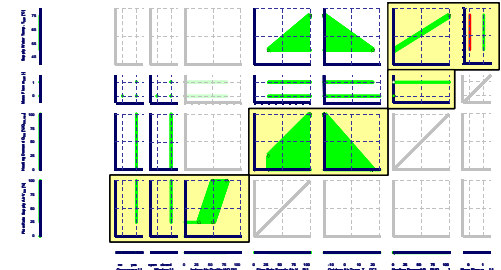
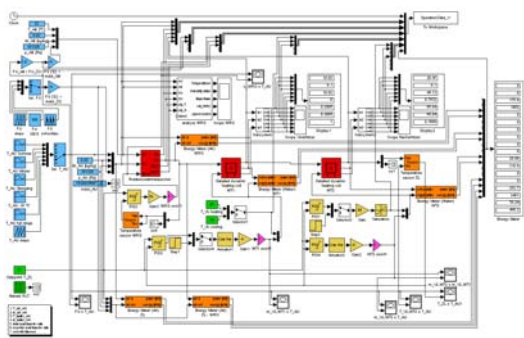
<p><b>Operation Diagnostics</b></p> 	<p><b>Data Visualization</b></p> <p>Operation Diagnostics uses advanced visualization techniques ('Pia') to display and analyze information that is hidden in the recorded BEMS data. 'Carpet Plots' can be used to analyze time series, 'Scatter Plot Matrices' can display interdependence of different operation states.</p>
<p><b>Operation Prognostics</b></p> 	<p><b>Operation Patterns</b></p> <p>Operation patterns have been developed to display operation and control strategies of systems in a clear and unmistakable way. The operation patterns can be used to verify the visualized data quickly.</p>
	<p><b>Simulation Models</b></p> <p>Simulation models are used to calculate exact operation data to generate optimal operation patterns and to be compared to measured data. Therefore the models need to fulfill following requirements:</p> <ul style="list-style-type: none"> <li>• Calibrated models using manufacturers data</li> <li>• Controllers and control strategies to be implemented in models</li> <li>• Small time steps up to seconds</li> </ul>

## Practical experiences

### Data Visualization

- Recorded BEMS data provides much more information than usually used, using advanced and multi-dimensional visualization techniques
- Patterns are adequate to analyze large amounts of data and to recognize wrong operation quickly
- Expert knowledge is necessary to identify relevant data to be analyzed and to identify reasons for malfunctioning of systems

### Simulation Models

- Simulation models can help to understand dynamic operation and behaviour of systems
- Models are time consuming and expensive and therefore no standard applications



# DEMONSTRATION PROJECT ON COMMISSIONING

## IT-Dynamo building of Jyväskylä Polytechnic



- ☞ Location: Jyväskylä, Finland
- ☞ Type of building: educational building
- ☞ Year of construction: 2002-2003
- ☞ Size: 9500 m<sup>2</sup>
- ☞ Contacts:
  - [Timo Kalema](mailto:timo.kalema@tut.fi) timo.kalema@tut.fi
  - [Hannu Keränen](mailto:hannu.keranen@tut.fi) hannu.keranen@tut.fi

### Description of HVAC system

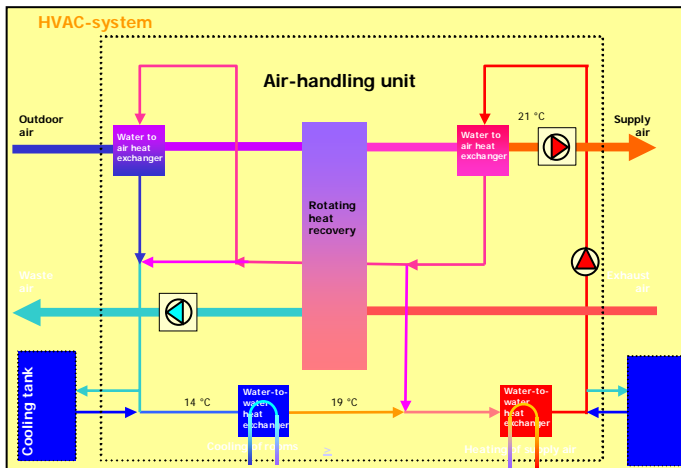

#### Ventilation

- 6 air-handling units
- Variable air volume flow ventilation (VAV) system
- Ventilation volume flows are controlled with CO<sub>2</sub>- and temperature sensors situated in the rooms

#### Heating and cooling

- Heating and cooling panels are mounted in the ceiling
- The cooling system uses cold outdoor air to cool down the return liquid from the rooms' panels
- 3-pipe system (a common return pipe)
- Floor heating is used in the first floor
- Cold outdoor air is used to cool down the rooms transferring the overheat from the rooms to the supply air using several (water-to-water) heat exchangers

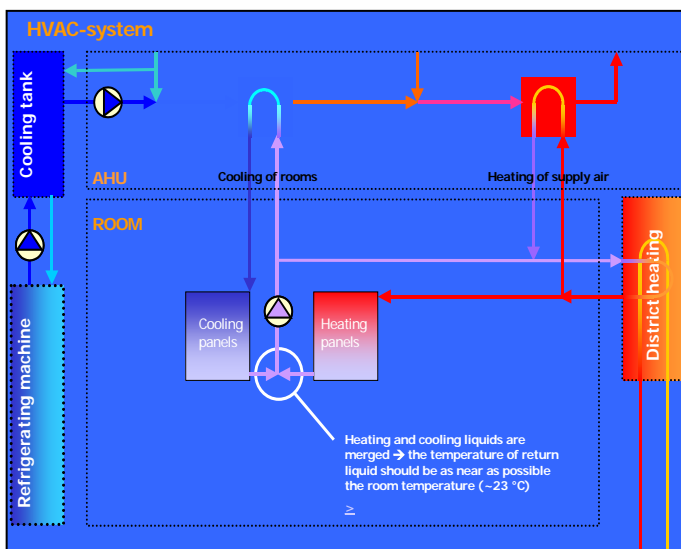

#### Control system

- PI-controllers in all devices
- Ventilation and cooling have a common control system

#### BAS

- Building automation system scores data every 2<sup>nd</sup> or 5<sup>th</sup> minutes
- Data of about 200 measurement points are stored and can be utilized in commissioning

## Commissioning project

<b>Objectives:</b>	<ul style="list-style-type: none"> <li>• To evaluate the energy consumption of the building using measurements and simulation programs in commissioning</li> <li>• To compare real and calculated energy consumptions and make a calibrated simulation model</li> <li>• To evaluate the indoor air climate</li> </ul>
<b>Type of Commissioning:</b>	<ul style="list-style-type: none"> <li>• Continuous commissioning</li> </ul>
<b>Phases concerned:</b>	<ul style="list-style-type: none"> <li>• Operating phase</li> </ul>
<b>Target users:</b>	<ul style="list-style-type: none"> <li>• Facility managers, the installing company</li> </ul>

## Tools and methods developed

<b>Calculation tools</b>	<p><b>Simulation models, system models and component models have been made or used:</b></p> <ul style="list-style-type: none"> <li>• The whole building is modelled using IDA-ICE</li> <li>• One AHU is modelled using EES and macros of IDA-ICE</li> <li>• A ductwork and its AHU is modelled using MagiCAD</li> <li>• A model for heating and cooling system is made with EES and Matlab</li> </ul>
<b>Manual tools</b>	<p>Some manual tools were tested</p> <ul style="list-style-type: none"> <li>• Air volume flows have been measured with Pitot-tubes</li> <li>• Air pressures have been measured in one of the AHUs</li> <li>• Electricity consumption of the fans is measured using the fan specific characteristics</li> <li>• The mass flow rate of cooling liquid has been measured once using ultrasonic measuring</li> </ul>
<b>Automatic Cx Tools</b>	<ul style="list-style-type: none"> <li>• Air temperatures have been visualised using models based on Matlab and Excel. These have been utilised when estimating the performance of the systems.</li> <li>• Results are presented e.g. in graphs and duration curves.</li> </ul>

## Practical experiences

### **Cx-actions**

- Developing a calibrated whole-building energy model
- Developing a fan-duct model and utilising it in Cx
- Detecting and eliminating simultaneous heating and cooling in working rooms
- Correcting an improper working in a liquid loop of the heating and cooling system.

## DEMONSTRATION PROJECT ON COMMISSIONING

### Office House for VTT Information Technology

	☞ Location: Espoo, Finland
	☞ Type of building: office building
	☞ Year of construction: 2004-2005
	☞ Size: 8732 m <sup>2</sup>
	☞ Contacts: <ul style="list-style-type: none"> <li>• <a href="mailto:jorma.pietilainen@vtt.fi">Jorma Pietiläinen</a> jorma.pietilainen@vtt.fi</li> <li>• <a href="mailto:janne.peltonen@vtt.fi">Janne Peltonen</a> janne.peltonen@vtt.fi</li> </ul>

### Description of Building System

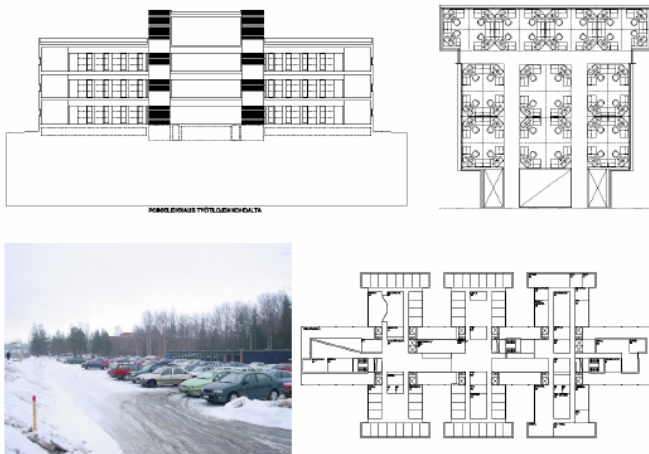

### New tools for measurements, analysis, performance control and verification

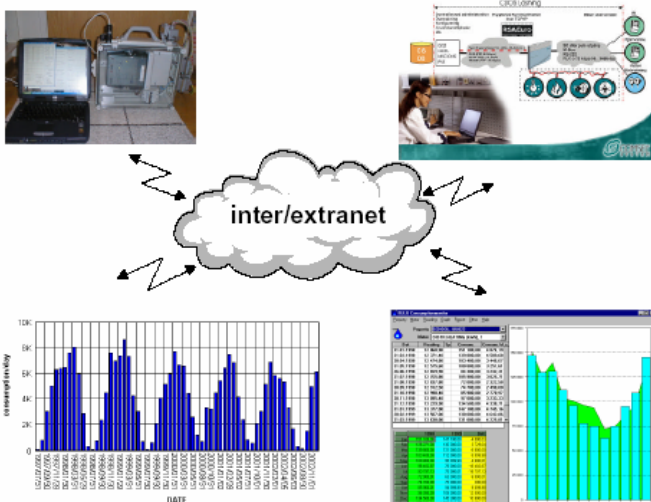

#### Ventilation

- 3 machine rooms for air handling units
- 6 air handling units
- Variable air volume flow ventilation (VAV) system
- Ventilation volume flows are controlled with frequency converters
- Each zone (6) is controlled separately based on CO<sub>2</sub> and temperature measurements

#### Heating and cooling

- Heating and cooling panels are mounted in the ceiling
- Radiators are mounted in the walls

#### Control system

- Room control software is distributed to the LonWorks modules
- HVAC equipment control is done with separate control software

#### BAS

- Room control is implemented using open LonWorks technology
- Other HVAC systems are controlled and supervised with DDC technology
- BAS can be remotely controlled with PC including control software and modem
- Alarms can be sent to mobile phones using SMS messages
- All measurements are saved to the database every 1-60 minutes
- Application reports include information of heat energy, water and electricity consumption

## Commissioning project

<b>Objectives:</b>	<ul style="list-style-type: none"> <li>• To evaluate the energy and water consumption of the building using measurements and software tools</li> <li>• To evaluate the indoor air climate of the building using measurements and software tools</li> <li>• To evaluate the building system operation using measurements and software tools</li> </ul>
<b>Type of Commissioning:</b>	<ul style="list-style-type: none"> <li>• Continuous commissioning</li> </ul>
<b>Phases concerned:</b>	<ul style="list-style-type: none"> <li>• Operating phase</li> </ul>
<b>Target users:</b>	<ul style="list-style-type: none"> <li>• Facility managers, the installing company</li> </ul>

## Tools and methods

<b>Calculation tools</b>	<ul style="list-style-type: none"> <li>• Web-based software tools e.g. Taloinfo, e3Portal, WebKulu</li> <li>• Others under development</li> </ul>
<b>Manual tools</b>	<ul style="list-style-type: none"> <li>• Indoor air climate conditions testing</li> <li>• Building system operation testing</li> </ul>
<b>Automatic Cx Tools</b>	<ul style="list-style-type: none"> <li>• Data visualization and calculation tools e.g. Excel and Matlab</li> </ul>

## Practical experiences

### *Cx-actions*



- Supervising the construction process and detecting weaknesses and faults
- Setting up the background for the online measurements
- Continuous commissioning using BEMS and up-to-date software tools

## DEMONSTRATION SITE: CREVECOEUR LE GRAND

### Description of building: Crèvecoeur Le Grand, nursery school

	☞ Location: Crèvecoeur Le Grand – France
	☞ Type of building: Nursery school
	☞ Year of construction: 2003-2004
	☞ Size: 2500 m <sup>2</sup> (heated floor)
	☞ Contacts: <ul style="list-style-type: none"> <li>• B Viaud: <a href="mailto:benedicte.viaud@edf.fr">benedicte.viaud@edf.fr</a></li> <li>• B Clemençon: <a href="mailto:bernard.clemencon@edf.fr">bernard.clemencon@edf.fr</a></li> <li>• M Jandon : <a href="mailto:jandon@cstb.fr">jandon@cstb.fr</a></li> <li>• H Vaezi Nejad : <a href="mailto:vaezi@cstb.fr">vaezi@cstb.fr</a></li> </ul>

### Description of HVAC system

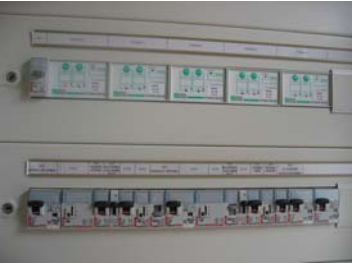
		<p><b>Plant level</b></p> <ul style="list-style-type: none"> <li>• 2 Air Handling Units, Constant Air Volume (CAV): <ul style="list-style-type: none"> <li>-AHU1 heating coil 24 kW</li> <li>-AHU2 heating coil 16 kW</li> </ul> </li> <li>• DHW by storage</li> <li>• Mechanical ventilation</li> </ul> <p><b>Zone level</b></p> <ul style="list-style-type: none"> <li>• Heating ceiling panels (classroom)</li> <li>• Lighting</li> </ul> <p><b>BEMS system</b></p> <ul style="list-style-type: none"> <li>• Brand: Pyram 500 (Delta Dore) :</li> <li>• Size: 80 points</li> <li>• Supervisor: Pyram</li> </ul>
		

### Commissioning project

<b>Objectives:</b>	<ul style="list-style-type: none"> <li>• To develop and automatic tool for electrical application managing the whole commissioning process</li> </ul>
<b>Type of Commissioning:</b>	<ul style="list-style-type: none"> <li>• Initial and Continuous Commissioning</li> </ul>
<b>Phases concerned:</b>	<ul style="list-style-type: none"> <li>• Acceptance and Operating phases</li> </ul>
<b>Target users:</b>	<ul style="list-style-type: none"> <li>• Facility manager, Operating agent</li> </ul>

## Tools and methods tested

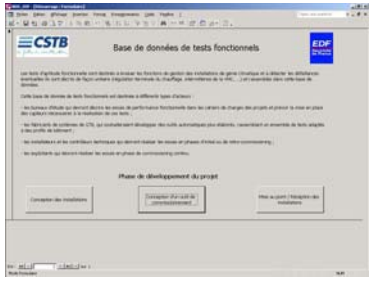
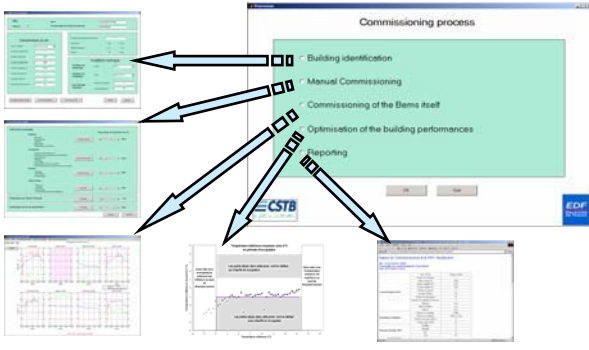
<p><b>Manual tools</b></p> 	<p><b>Database of Functional Test Procedure</b></p> <p>Procedures are given for:</p> <ul style="list-style-type: none"> <li>• Testing elementary functions</li> <li>• Details of requirements, supplementary needed equipments, goals to reach to determine the reliability of the function</li> </ul>
<p><b>Automatic Cx Tools</b></p> 	<p><b>Automated Cx process management</b></p> <p>BEMS assisted tools to enable the whole Cx building:</p> <ul style="list-style-type: none"> <li>• Identification phase to identify the specific information about the building and its technical description</li> <li>• Manual Cx phase to check the technical installations (presence, location, cabling ...)</li> <li>• Cx of the BEMS itself to check the compliance of the functions implemented with the building owner requirements and to check it operates according to the book of specifications.</li> <li>• Optimisation of the building performances in term of comfort, energy consumption and operating costs.</li> <li>• Reporting phase to report the work of the Commissioning Agent to the Building Owner.</li> </ul>

## Practical experiences

### User interviews

Occupant Interview	Operator Interview
<ul style="list-style-type: none"> <li>• Some classrooms are too cold (on Monday morning)</li> <li>• Lack of labelling in the electrical boxes</li> <li>• Lack of manual override possibilities</li> </ul>	<ul style="list-style-type: none"> <li>• Non optimal AHU control</li> <li>• Discrepancy between BEMS and ventilation operation</li> <li>• Under heating in north zone</li> <li>• Some technical applications were in manual mode after the acceptance phase</li> </ul>

### Cx actions

- Occupant and operator interviews
- Design review, collect and check of the available documents
- Installation review and verification of the sensors and actuators
- Configuration of the tools
- Passive testing of control functions of BEMS

### Cx Recommendations

Manual	1	Design Review	Check the documentation of the technical installation Check that the design documents are complete and have been updating
	2	Installation Review and Verification	Conduct a field inspection to check the technical installation
BEMS assisted	3	Installation Review and Verification with BEMS	Verify mismatch between BEMS control logic and design documents
	4	Measurement Verification with BEMS	Define measurements to log with BEMS, evaluate data for compliance
	5	Documentation	Document the result of the commissioning analysis





## DEMONSTRATION SITE: ARIA BUILDING FRANCE

### Description of building: Aria building, research building of CSTB

	☞ Location: Marne la Vallée – France
	☞ Type of building: Office and laboratories building
	☞ Year of construction: 1999-2000
	☞ Size: 2000 m <sup>2</sup> (conditioned floor and heated floor)
	☞ Contacts: <ul style="list-style-type: none"> <li>• H Vaezi Nejad : <a href="mailto:vaezi@cstb.fr">vaezi@cstb.fr</a></li> <li>• M Jandon : <a href="mailto:jandon@cstb.fr">jandon@cstb.fr</a></li> <li>• N Castro : <a href="mailto:natascha@nist.gov">natascha@nist.gov</a></li> </ul>

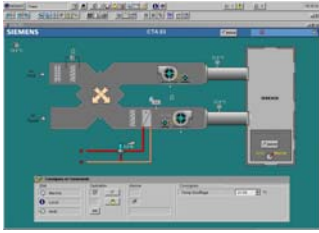
### Description of HVAC system

		<p><b>Plant level</b></p> <ul style="list-style-type: none"> <li>• 1 chiller: 62 kW</li> <li>• 2 gas boilers: 2 X 170 kW</li> <li>• 3 Air Handling Units, Constant Air Volume (CAV):</li> <li>• -AHU1 (Bio Lab space), heating and cooling coil</li> <li>• -AHU2 (Lab space), heating and cooling coil, humidifier</li> <li>• -AHU3 (Office space) with recovery heat exchanger, heating coil.</li> </ul>
		<p><b>Zone level</b></p> <ul style="list-style-type: none"> <li>• Radiators (offices)</li> <li>• Fan Coil Unit (laboratories)</li> </ul> <p><b>BEMS system</b></p> <ul style="list-style-type: none"> <li>• Brand: Desigo (Siemens) :</li> <li>• Size: 200 points</li> <li>• Local controller: Siemens PRV2-64</li> <li>• Supervisor: Desigo Insight</li> </ul>

### Commissioning project

<b>Objectives:</b>	<p><b>Solve occupant complaints concerning the thermal comfort</b></p> <ul style="list-style-type: none"> <li>• Evaluation of the AHU s performance</li> <li>• Improvement of the facility manager knowledge on the HVAC operating</li> <li>• Testing, Adjusting and Balancing of the control systems</li> </ul>
<b>Tpe of Commisioning:</b>	<ul style="list-style-type: none"> <li>• Re Commissioning</li> </ul>
<b>Phases concerned:</b>	<ul style="list-style-type: none"> <li>• Operating phase</li> </ul>
<b>Target users:</b>	<ul style="list-style-type: none"> <li>• Facility manager</li> </ul>

## Tools and methods developed

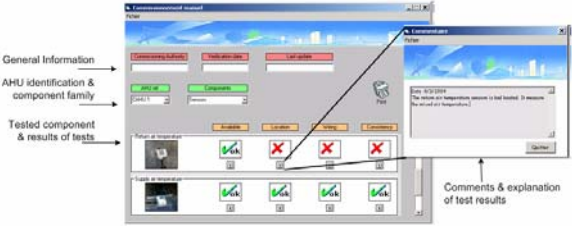
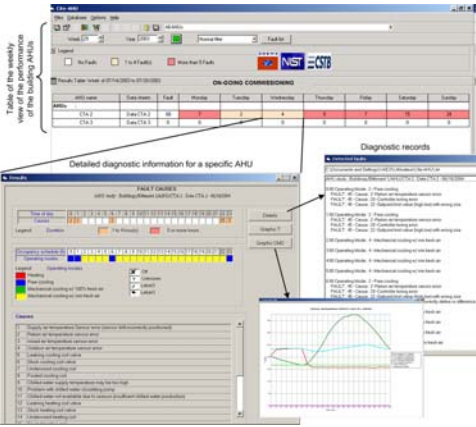
<p><b>Manual tools</b></p> 	<p><b>Guidelines for manual Cx of Air Handling Unit</b></p> <p>For example, to test the “Return Air Temperature Sensor” the user must answer the following questions:</p> <ol style="list-style-type: none"> <li>1. Is the sensor really available?</li> <li>2. Is the sensor placement optimal for measuring the physical phenomena?</li> <li>3. Is the sensor correctly connected to the control equipment (wiring)?</li> <li>4. Is the sensor measurement consistent with reference values?</li> </ol>
<p><b>Automatic Cx Tools</b></p> 	<p><b>CITE-AHU: Automated Cx software</b></p> <p>BEMS assisted tools to enable active and passive testing</p> <ul style="list-style-type: none"> <li>• Handover phase or seasonal testing: active testing scenario executed automatically during unoccupied period</li> <li>• Weekly or monthly testing: passive testing with detection and diagnostic of faults</li> <li>• The basis for the analysis used a set of expert rules designed to assess the performance of AHUs using Bems data</li> <li>• CITE-AHU is a stand alone tool (not embedded in the bems)</li> </ul>

## Practical experiences

### Users interview

Occupant Interview	Operator Interview
<ul style="list-style-type: none"> <li>• Offices are too hot in mid-season and summer period, cold in winter</li> <li>• Offices have excessive glare</li> <li>• Laboratory specifications for air quality humidity, and indoor temperature are not met</li> </ul>	<ul style="list-style-type: none"> <li>• We don't know exactly what kind of equipment has been installed</li> <li>• We don't know how it operates</li> <li>• Some technical equipments are not accessible</li> <li>• Poor quality of ventilation system</li> </ul>

### Cx actions

- Occupant and operator interviews
- Design review, collect and check of the available documents
- Installation review and verification of the sensors and actuators
- Configuration of CITE-AHU
- Active and Passive testing of AHUs and its control system
- Documenting: test results, performance of AHUs and evaluation of cost-benefit of commissioning

### Cx Recommendations

Manual	1	Design Review	Check control logic, sensor placement and sensor accuracy with design documents
BEMS assisted	2	Installation Review and Verification	Conduct a field inspection to determine installed characteristics of the equipment including condition and sensor availability (real location)
	3	Installation Review and Verification with BEMS	Verify mismatch between BEMS control logic and design documents
	4	Measurement Verification with BEMS	Define measurements to log with BEMS, evaluate data for compliance
	5	Forced Response Testing and Analysis	Analyse performance of the system with the Commissioning tools.
	6	Documentation	Document the result of the commissioning analysis





## DEMONSTRATION SITE: PB6 FRANCE

### Description of building: PB6, headquarters building of EDF

	☞ Location: Paris, la Defense – France
	☞ Type of building: Office building
	☞ Year of construction: 1999-2001
	☞ Size: 63220 m <sup>2</sup> 48 conditioned floors
	☞ Contacts: <ul style="list-style-type: none"> <li>• B Viaud: <a href="mailto:benedicte.viaud@edf.fr">benedicte.viaud@edf.fr</a></li> <li>• B Clemençon: <a href="mailto:bernard.clemencon@edf.fr">bernard.clemencon@edf.fr</a></li> <li>• M Jandon: <a href="mailto:jandon@cstb.fr">jandon@cstb.fr</a></li> <li>• P Riederer: <a href="mailto:riederer@cstb.fr">riederer@cstb.fr</a></li> </ul>

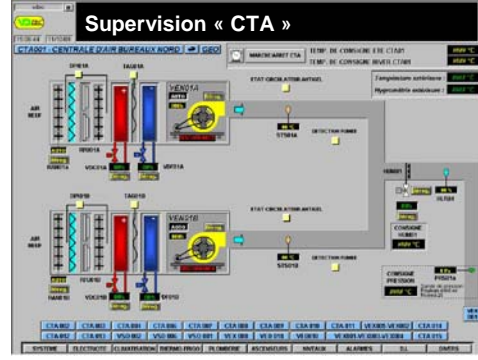
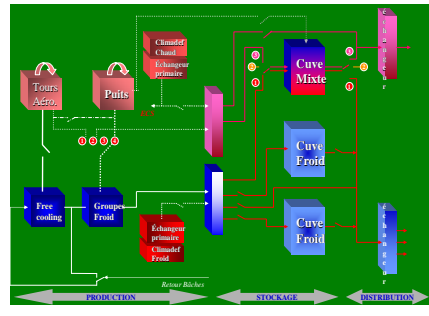
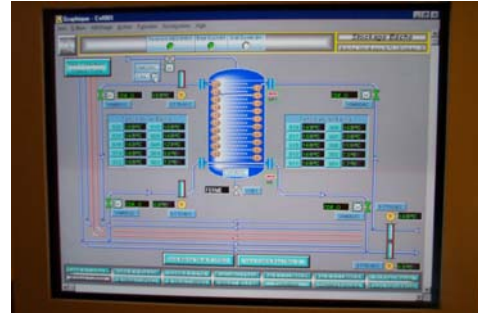
### Description of HVAC system

		<p><b>Plant level</b></p> <ul style="list-style-type: none"> <li>• District heating and cooling</li> <li>• 2 Heat pumps</li> <li>• Thermal storage</li> <li>• 15 AHUs</li> </ul> <p><b>Zone level</b></p> <ul style="list-style-type: none"> <li>• 3000 Fan Coil Units</li> <li>• 10000 lights</li> <li>• 5000 blinds</li> </ul> <p><b>BEMS system</b></p> <ul style="list-style-type: none"> <li>• Field network: Lonworks</li> <li>• Automation network: Ethernet</li> <li>• Johnson Control system: plant</li> <li>• PCVue System: AHU and alarms</li> <li>• Local controller for FCU, light and blind (Lonwork)</li> </ul>
		

### Commissioning project

<b>Objectives:</b>	<ul style="list-style-type: none"> <li>• Office building part: Improve the comfort of the occupants (Indoor air quality)</li> <li>• The whole building: Improve and optimize the building operating and the energy performance by using simulation tool:             <ul style="list-style-type: none"> <li>☞ To evaluate the impact of a modification of the technical installation schedule on the Indoor air quality.</li> <li>☞ To optimize the heating and cooling production according to the occupation schedule of the building</li> </ul> </li> </ul>
<b>Type of Commissioning:</b>	<ul style="list-style-type: none"> <li>• Re Commissioning, Continuous Commissioning</li> </ul>
<b>Phases concerned:</b>	<ul style="list-style-type: none"> <li>• Operating phase</li> </ul>
<b>Target users:</b>	<ul style="list-style-type: none"> <li>• Facility manager, building operator</li> </ul>

## Tools and methods developed

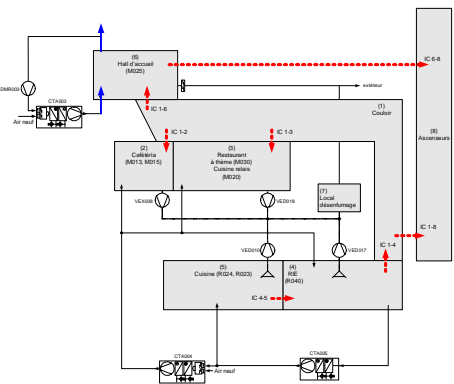
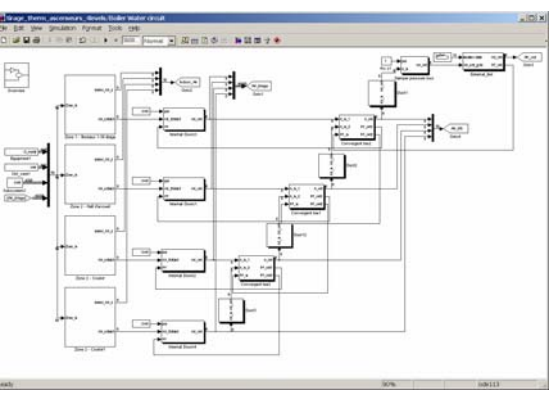
<p><b>Methods</b></p> 	<p><b>Phase 1: to understand the phenomena</b></p> <ul style="list-style-type: none"> <li>• Analysis of the technical drawings and documentation of the building</li> <li>• Inspection of the technical installations and verification of air flow rates</li> </ul> <p><b>Phase 2: to make a functional scheme in the building</b></p> <ul style="list-style-type: none"> <li>• Identification of zones concerned and definition of a functional scheme of potential air flow patterns</li> <li>• Verification of schedules of ventilation systems (AHUs, extract fans, dampers ...)</li> </ul> <p><b>Phase 3: to develop a simplified simulation model of the building</b></p>
<p><b>Commissioning Tool using model</b></p> 	<p><b>Use of the simulation tool “SIMBAD Building and HVAC Toolbox” to simulate the impact of AHU schedule on air flow patterns</b></p> <ul style="list-style-type: none"> <li>• Define groups of homogeneous zones (in terms of pollutant)</li> <li>• Define the air flow rate in each zone according to the design values of the ventilation systems</li> <li>• Run simulation to estimate the directions of air movement and pollutant transport</li> <li>• Give a qualitative analysis and some advices on the way to manage the ventilation system in order to avoid pollutant transport in the building</li> </ul> <p><b>Next Step: Apply this methodology to estimate the Impact of occupation schedule in heating and cooling production</b></p>

## Practical experiences

### User's interview

<b>Facility Manager and Operator interview</b>	
	<ul style="list-style-type: none"> <li>• Problem of cooking odour in the reception area</li> <li>• Necessity of a large flexibility of the technical system to take into account frequent modification (occupation schedule, space, ...)</li> <li>• Lack of update documentation on the technical installation and building operating</li> </ul>

### Cx actions

- Facility Manager and operator interviews
- Design review, collect and check of the available documents
- Inspection and measurement in parallel of the simulation work to calibrate the models
- Drawing up of a functional scheme from the detailed plan to have a better understanding of the air flow phenomena
- Simulation of the concerned zones
- Report of work

### Cx Recommendations



Manual	1	Design Review	Check the documentation of the technical installation Check that the design documents are complete and have been updated
	2	Installation Review and Verification	Conduct a field inspection to check the technical installation
BEMS assisted	3	Installation Review and Verification with BEMS	Verify mismatch between BEMS control logic and design documents
	4	Measurement Verification with BEMS	Define measurements to log with BEMS, evaluate data for compliance
	5	Forced Response Testing and Analysis	Analyse performance of the system with the testing procedures
	6	Documentation	Document the result of the commissioning analysis

## DEMONSTRATION SITE: SCHOOLS OF THE CITY OF PARIS FRANCE

### Demonstration site: Schools of the City of Paris FRANCE

	☞ Location: Paris, France
	☞ Type of building: School buildings
	☞ Year of construction: from 19th-century to 2000
	☞ Size: 500 m <sup>2</sup> to 5000 m <sup>2</sup>
	☞ Contacts: <ul style="list-style-type: none"> <li>• H Vaezi Nejad : <a href="mailto:vaezi@cstb.fr">vaezi@cstb.fr</a></li> <li>• M Jandon : <a href="mailto:jandon@cstb.fr">jandon@cstb.fr</a></li> <li>• Ch. Detaille : <a href="mailto:charlotte.detaille@paris.fr">charlotte.detaille@paris.fr</a></li> </ul>

### Description of HVAC system

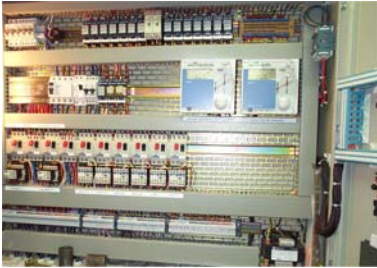
		<p><b>Plant level</b></p> <ul style="list-style-type: none"> <li>• 2 to 4 gas boilers or District Heating</li> <li>• Simple Air Handling Units, Constant Air Volume</li> <li>• Exhaust Ventilation or Natural Ventilation</li> </ul> <p><b>Zone level</b></p> <ul style="list-style-type: none"> <li>• Radiators (offices)</li> </ul> <p><b>BEMS system : Remote Control System</b></p> <ul style="list-style-type: none"> <li>• Brand: Multiple companies (Satchwell, Siemens, ...)</li> <li>• Size: 20 to 50 points per building</li> <li>• Local controller: Multiple companies (Satchwell, Siemens, etc.)</li> <li>• Supervisor: DEROZIER (DTS)</li> </ul>
		

### Commissioning project

<b>Objectives:</b>	<p><b>Solve occupant complaints concerning thermal comfort</b></p> <ul style="list-style-type: none"> <li>• Develop, validate and document a semi-automatic re-commissioning tool that uses the Remote Control Systems to analyse the performance of large numbers of heating plants</li> <li>• Assist the operator in diagnosing the defects that cause faulty process operation</li> </ul>
<b>Type of Commissioning:</b>	<ul style="list-style-type: none"> <li>• Re-Commissioning and On-going Commissioning</li> </ul>
<b>Phases concerned:</b>	<ul style="list-style-type: none"> <li>• Occupancy and Operation Phase</li> </ul>
<b>Target users:</b>	<ul style="list-style-type: none"> <li>• Mechanical engineers and technicians of the city of Paris</li> </ul>

## Tools and methods applied

<p><b>Analysing tools</b></p>	<p><b><u>Detect low performance buildings</u></b></p> <p>For example, to define the energy performance of a school building:</p> <ol style="list-style-type: none"> <li>1. Collect information about the school building to define to which typology of school it can be attached</li> <li>2. Calculate the indicator of performance E.g: kWh/year/m2, kWh/year /pupil, ...</li> <li>3. Compare the performance of the school with others schools of the same typology</li> </ol>
<p><b>Automatic Cx Tools</b></p>	<p><b><u>Ecole-Cx: Semi-Automated Cx Software</u></b></p> <p>BEMS assisted tools to enable passive testing</p> <p>The software gives users access to three main groups of tests:</p> <ul style="list-style-type: none"> <li>• Sizing and Balancing</li> <li>• Control and Automation</li> <li>• Energy Consumption and Comfort</li> </ul> <p>In each main group of tests, adapted graphs or tables help users assess the building HVAC, including:</p> <ul style="list-style-type: none"> <li>• Under or over sizing of heating plant</li> <li>• Under or over production of hot water, scaling</li> <li>• Boiler sequencing</li> <li>• Optimal start/stop</li> </ul>

## Practical experiences

### User interviews

Occupant Interview	Operator Interview
<ul style="list-style-type: none"> <li>• Schools are cold in winter and sometime too hot in mid-season and summer period</li> <li>• The solar protection is not effective</li> <li>• Zone divisions are not always adapted to the heating circuits</li> </ul>	<ul style="list-style-type: none"> <li>• We need a tool to assist us in evaluating the energy performance of school, heating plants and for adjusting the control systems</li> <li>• The ventilation systems are rarely tested</li> <li>• The commissioning tool must be simple to use</li> </ul>

### Cx actions

- Design review, operator interview: collect and check the available documents
- Installation review and verification: conduct a field inspection to determine installed characteristics of the equipment
- Define useful data to log with the Remote Control System
- Identify the low performance schools
- Passive testing of heating plants and its control system
- Tuning, adjusting and balancing of heating plants
- Document: test results, energy performance of schools

### Cx Recommendations

- Analyse user needs: identify, together with the operator, the main heating plant functions to assess and the important problems to highlight
- Provide the operator a clear explanations of the causes of fault detected
- Assist the operator to commission buildings and let them decide about the causes of the poor performance
- Evaluate tradeoffs between the time spent on commissioning and the improvement in energy consumption and comfort which can be achieved from this process



## DEMONSTRATION SITE: UNIVERSITY BUILDING, SAINT-ETIENNE, FRANCE

### Demonstration site: University of Saint-Etienne, FRANCE

	☞ Location: Saint Etienne, Rhône-Alpes, France
	☞ Type of building: type 3, two identical lecture rooms
	☞ Year of construction: <b>non available</b>
	☞ Size: 950 m <sup>3</sup> per room (until 300 persons per room)
	☞ Contacts: <ul style="list-style-type: none"> <li>• O. Morisot : <a href="mailto:olivier.morisot@elyo.fr">olivier.morisot@elyo.fr</a></li> <li>• D. Marchio: <a href="mailto:dominique.marchio@ensmp.fr">dominique.marchio@ensmp.fr</a></li> <li>• S. Ginestet: <a href="mailto:stephane.ginestet@ensmp.fr">stephane.ginestet@ensmp.fr</a></li> </ul>

### Description of HVAC system

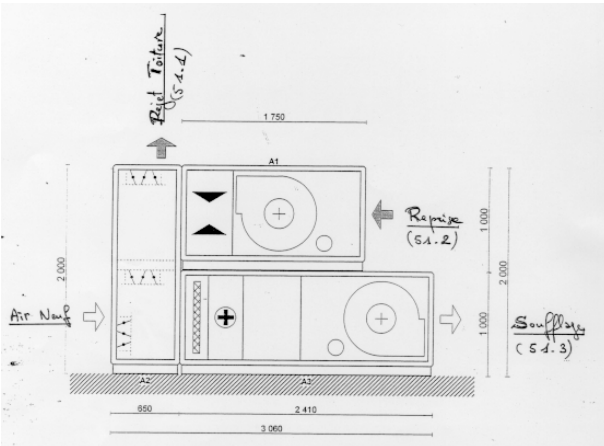
	<p><b>Plant level</b></p> <ul style="list-style-type: none"> <li>• One AHU for each room (2 identical AHU)</li> <li>• Supply/exhaust: 6000 m<sup>3</sup>/h</li> <li>• Hot water coil: 160 kW</li> </ul> <p><b>AHU 1 (room 1)</b></p> <ul style="list-style-type: none"> <li>• Damper position fixed at 30% of fresh air</li> </ul> <p><b>AHU 2 (room 2): two VFD installed on the 2 fan motors</b></p> <ul style="list-style-type: none"> <li>• Control of the supply/exhaust flow rate by the CO<sub>2</sub> rate (priority) and the indoor air temperature</li> <li>• The dampers position depend on outside/inside temperatures and CO<sub>2</sub> rate</li> </ul>
--	---

### Commissioning project

<b>Objectives:</b>	<b>Test of several Retro- and On-going Commissioning Tools</b> Twelve tools have been evaluated. Among these, five were considered applicable on a real building, according the French context. For the three tools really available: PEI guide, Emma-CTA from CSTB, and IPMVP from DOE and ASHRAE, a synthesis, and a feedback report were drawn up.
<b>Type of Commissioning:</b>	<ul style="list-style-type: none"> <li>• Retro-Commissioning and On-going Commissioning</li> </ul>
<b>Phases concerned:</b>	<ul style="list-style-type: none"> <li>• Operation and maintenance Phase</li> </ul>
<b>Target users:</b>	<ul style="list-style-type: none"> <li>• Operation and maintenance technical staff</li> </ul>

## Tools and methods tested on the two AHU: Effectiveness and profitability

<p><b>PECI Guide</b></p>	<p>Detection of some faults: air leakage, sensor's bad localisation, rod out of order, sensor's inversion...</p> <p>On the other hand, control and programming faults, bad choice and selection of the equipment, bad balanced hydraulic and aeraulic networks, aren't taken into account. The tool's implementation corresponds to time spent (half a day for an AHU). No purchase and no particular training were necessary.</p>
<p><b>IPMVP</b></p>	<p>The study pointed out :</p> <ul style="list-style-type: none"> <li>- the rather high cost of many options (B and D)</li> <li>- the easiness and the quickness of other options (A and C)</li> </ul> <p>However, the user must be careful to write properly his hypothesis to justify accuracy of his calculations.</p> <p>The absence of procedure makes the IPMVP more a mental frame, in which procedures must be invented for each case.</p>
<p><b>CITE-AHU : Emma-CTA (Fault detection and diagnosis tool)</b></p>	<p>The modified expert rules permit to detect the following faults on the AHU n°1 :</p> <ul style="list-style-type: none"> <li>- fault on temperature sensor</li> <li>- pumping phenomena of the valve</li> <li>- wrong valve position</li> <li>- wrong alarm appearance</li> </ul> <p>The cost of the use of this tool can be reduced by using a new version on the tool, which can be parameter in function of the different layouts.</p>
<p><b>IAQ-Op</b></p>	<p>This tool is a graphical programming tool based on Matlab/Simulink environment.</p> <p>It has been developped by Cenerg. It permits to evaluate the impact of the faults on energy consumption and on IAQ.</p> <p>It requires a hight technical level in HVAC procedures.</p>

- **PECI tool** : the taking charge of an installation, is limited in time and occur during occupancy of the building, so it is difficult (indeed impossible, according external conditions) to strain the equipment to work in all cooling modes. Thus, it is judicious to concentrate in this phase the detection of mechanical faults and the checking of the plant. Savings have been evaluated by simulation in terms of energy, but also in terms of indoor air quality. **The procedure appears efficient and cost-effective.**
- **Emma-CTA tool**: the tool presents **an interesting complement** to the retro-commissioning tool seen before. The desirable evolution will be to have an adaptable version on the main existing AHU architectures, without being exhaustive and keeping its simple use. So PECI and Emma CTA constitute a coherent tool adapted to the different phases (taking charge of the installation, running, periodical tests). According to this approach, the tool CITE-AHU (CSTB, NIST) build during Annex 40 fulfil the phases commissioning / retro-commissioning / on-going commissioning
- **IPMVP tool** : the four options (or operational declinations) evaluations of IPMVP have been applied on pilot site. To come within the scope of the methodology presented is rather easy; however **procedures are to be written in each case and will be different in each category of considered solution.**

## DEMONSTRATION SITE: CULTURAL PALACE HUNGARY

### Description of building: Theatre, Concert Hall, Museum



- ☞ Location: Budapest – Hungary
- ☞ Type of building: Theatre, Concert Hall, Museum
- ☞ Year of construction: 2003 -2005
- ☞ Size: 60 000 m<sup>2</sup>
- ☞ Contacts:
  - Zoltan Magyar: [zmagyar@invitel.hu](mailto:zmagyar@invitel.hu)
  - Zoltan Virag : [virag@mail.tvnet.hu](mailto:virag@mail.tvnet.hu)

### Description of HVAC system



#### Plant level

- Cooling load: 3.300 kW  
2 chillers
- Heating load: 4.500 kW  
Supply from district heating network
- 35 Air Handling Units  
Variable Air Volume (VAV)  
Total air volume 200 000 m<sup>3</sup>/h

#### Zone level

- Radiators (offices)
- Fan Coil Units
- Floor Heating

#### BEMS system

- Brand: Honeywell
- Size
  - Theatre: 1750 points
  - Concert Hall: 2300 points
  - Museum: 1400 points

## Commissioning project

<b>Objectives:</b>	<ul style="list-style-type: none"> <li>• Current stage: Simulation-aided commissioning of design</li> <li>• Next stage: Examine how simulation model may support building commissioning</li> </ul>
<b>Type of Commissioning:</b>	<ul style="list-style-type: none"> <li>• Initial Commissioning</li> </ul>
<b>Phases concerned:</b>	<ul style="list-style-type: none"> <li>• Design, Construction phase</li> </ul>
<b>Target users:</b>	<ul style="list-style-type: none"> <li>• Building owner, HVAC designers</li> </ul>

## Tools and methods developed and/or used

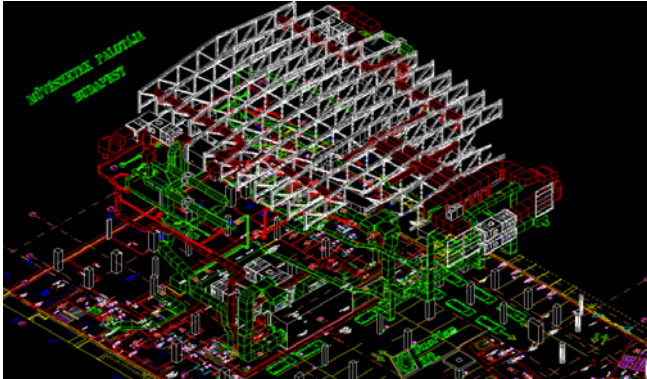
<p><b>Manual tools</b></p> 	<p><b><u>Functional Performance Test Procedure</u></b></p> <ul style="list-style-type: none"> <li>• Component level: Testing elementary functions</li> <li>• Simple system check procedure</li> <li>• Simple system verification after realisation</li> <li>• Details of requirements, supplementary needed equipments</li> </ul>
<p><b>Automatic Tools</b></p> 	<p><b><u>BEMS assisted tools to enable the commissioning process</u></b></p> <ul style="list-style-type: none"> <li>• Check the compliance of the functions implemented</li> <li>• Optimisation of the building performances in term of comfort, energy consumption, operating costs</li> </ul>

## Practical experiences

### Simulation

- Based on simulation it was revealed that the cooling capacity and air change rate was not sufficient to fulfil the requirements
- The simulation model helped to devise a better control strategy

### Cx actions

- Pre – design phase: simulation of air flow rate, thermal comfort
- Design phase: review the documents, add the necessary sensors, valves, dumpers, ...
- Construction phase: balancing the water and air system, review and verification of the sensors and actuators





## DEMONSTRATION SITE: HOTEL BUILDING SPAIN

### Description of building: NH Eurobuilding Hotel, Madrid, Spain

	☞ Location: Madrid – Spain
	☞ Type of building: Hotel building
	☞ Year of construction: 1969  The hotel recently has been renovated for 20 million euros.
	☞ Size: 50 000 m <sup>2</sup>
☞ Contacts:	
<ul style="list-style-type: none"> <li>• Zoltan Magyar : <a href="mailto:zmagyar@invitel.hu">zmagyar@invitel.hu</a></li> <li>• Stefan Aronsson : <a href="mailto:stefan.aronsson@cit.chalmers.se">stefan.aronsson@cit.chalmers.se</a></li> </ul>	

### Description of HVAC system

**Plant level**

- 2 chillers (Carrier)
- 2 gas boilers

**Zone level**

- 27 Air Handling Units, Constant Air Volume (CAV) for conference rooms, restaurant, lobby
- Radiators (bathrooms)
- Fan Coil Unit (guest rooms)

**BEMS system**

- Brand: Landis & Staefa

**Calor / Heating**

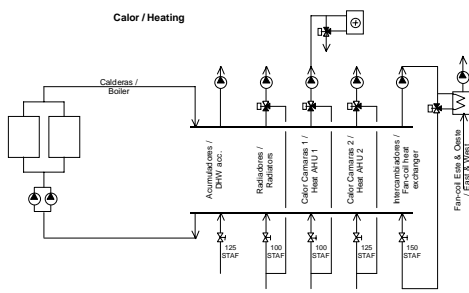

**Frio / Cooling**

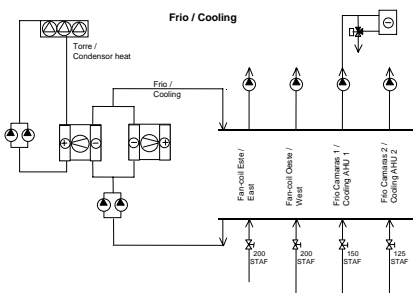

## Commissioning project

<b>Objectives:</b>	<b>Achieve better indoor environment with less energy</b> <ul style="list-style-type: none"> <li>• Evaluation of the HVACs performance</li> <li>• Improvement of the facility manager knowledge on the HVAC operating</li> <li>• Testing, Adjusting and Balancing of the control systems</li> </ul>
<b>Type of Commissioning:</b>	<ul style="list-style-type: none"> <li>• Re - Commissioning</li> </ul>
<b>Phases concerned:</b>	<ul style="list-style-type: none"> <li>• Operating phase</li> </ul>
<b>Target users:</b>	<ul style="list-style-type: none"> <li>• Facility manager, building owner</li> </ul>

## Tools and methods developed and/or used

<p><b>Manual tools</b></p> <p><b>CO2 in Salona Madrid</b> Many persons in the room (4/5)</p>	<p><b>Guidelines for manual commissioning</b></p> <p>For example, the 2-pipe system to the fan-coils in the guest rooms was not balanced. In some cases the main valves were missing from the system, making it impossible to balance. The balancing valves were mainly installed but with fully open position. After hydronic balancing we reduced the speed of the pump, setting the optimal setpoint of the distributor system.</p> <p>We measured the room temperature and CO2 level in the guest rooms and the conference rooms. Based on these dates we offered better indoor climate.</p>
<p><b>Automatic Tools</b></p>	<p><b>Software</b></p> <p>A building simulation software developed and marketed by CIT Energy Management AB, Sweden is used for energy use calculation.</p>

## Practical experiences

### Cx actions

- Design review, collect and check of the available documents
- Defining the demands, complaints
- Collect historical data of energy use and general building data
- Check up energy systems: building envelope, internal heat gains, HVAC systems, domestic hot water
- 15 potential energy saving measures
- 1 measure dealing with improved indoor air quality
- Calculation of savings
  - Potential electricity savings: 14 %
  - Potential heat savings: 21 %
  - Potential water savings: 10 %

## DEMONSTRATION SITE: K-BUILDING JAPAN

### Description of building:K-Building

	☞ Location: Kokura - Japan
	☞ Type of building: Complex (Hotel, Shopping Mall, Station, etc. )
	☞ Year of construction: 1996-1998
	☞ Size: Approx.86,000 m <sup>2</sup> (Total Floor Area )
	☞ Contacts: <ul style="list-style-type: none"> <li>• H.Izumiyama : <a href="mailto:izumiyama-hiroo@kajima.com">izumiyama-hiroo@kajima.com</a></li> <li>• N.Sagara : <a href="mailto:sagara@env.kitakyu-u.ac.jp">sagara@env.kitakyu-u.ac.jp</a></li> </ul>

### Description of HVAC and BEMS system

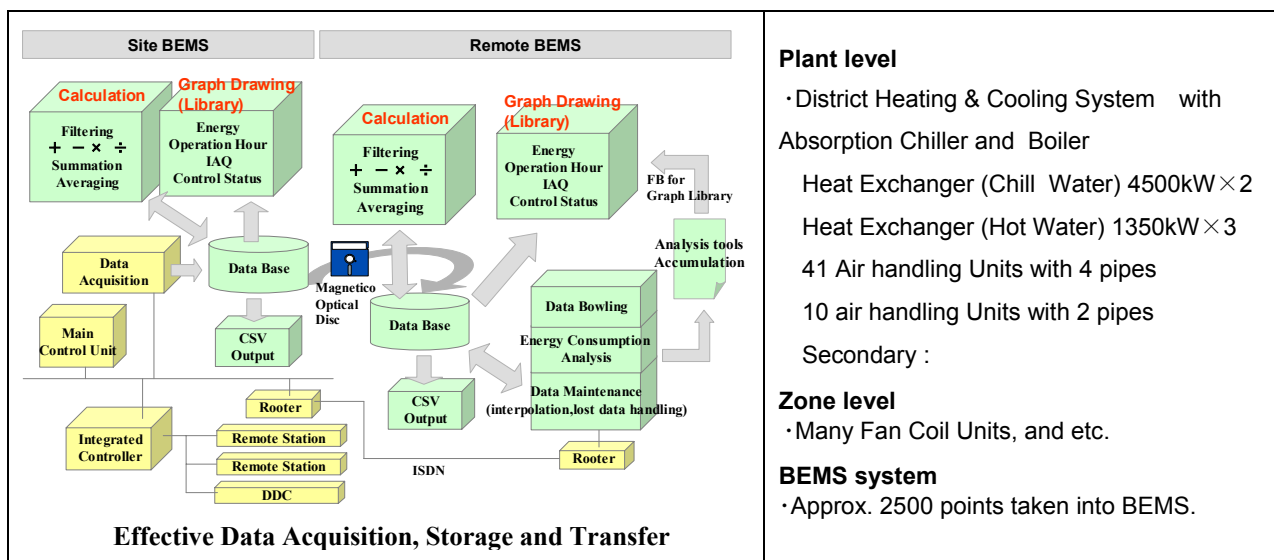

### Commissioning project

<b>Objectives:</b>	<ul style="list-style-type: none"> <li>• Energy Saving</li> <li>• FDD tools development</li> <li>• Basic Design Data Collection</li> </ul>
<b>Type of Commissioning:</b>	<ul style="list-style-type: none"> <li>• Manual Initial Cx-like</li> <li>• Initial Cx-like with BEMS</li> <li>• ReCx-like with BEMS</li> </ul>
<b>Phases concerned:</b>	<ul style="list-style-type: none"> <li>• All phases from Design through Post-acceptance</li> </ul>
<b>Target users:</b>	<ul style="list-style-type: none"> <li>• Building Owners</li> <li>• Design Professionals</li> <li>• Engineers, Building</li> <li>• Operators/Facility manager</li> </ul>

*Strictly speaking, this isn't a commissioning project because there wasn't a commissioning agent employed by the owner and wasn't enough commissioning documents fully illustrated with owner's project requirement, commissioning plan, commissioning specification and operation manuals. That's why commissioning is said commissioning-like.*

## Tools and methods tested

<p><b>Manual tools</b></p> <p><b>An Energy Saving Example</b></p>	<p><b>Energy Saving Tools from Expertise</b></p> <p>At the first year after turnover the dehumidifying with reheat were monitored at the site BEMS. It happened at an air handler for a dining hall in the hotel. We investigated the data carefully through the remote BEMS. Finally we found that operation was caused by the chill water control valve logic and the hall humidity setting. The valve opening was determined by humidity relating to the relatively low settings..</p> <p>After the correction for the causes of dehumidifying the chill water valve opening followed Gaussian Distribution with the mean of 50%. We proved our guess was right by showing the energy consumption reduction for a dining hall. The chill water energy decreased almost half and the steam energy disappeared at the 2nd and 3rd year.</p> <p>We also found other faults and rectified some of them from an energy saving point of view.</p>
<p><b>Automatic Cx Tools</b></p> <p><b>Graph Selection and Date Assignment</b></p>	<p>The necessary graph is selected from the menu shown right. You are expected to pick up a standardized term from each section. When you would like to know how much energy the chill water is monthly consumed, highlight "04 Air Handler", " 01 Daily.....", "06 Chill Water Energy" with mouse.</p>

## Practical experiences

### Users interview

Occupant Interview	Operator Interview
<ul style="list-style-type: none"> <li>Entrance temperature is too hot in summer</li> </ul>	<ul style="list-style-type: none"> <li>Occupants are not energy –conscious, say they always set temperature lower than designer expects.</li> <li>When humidity setting was changed by 10 % RH, Energy Consumption reduced. But There were some dew condensation occurred in a corridor.</li> </ul>

Many faults were detected through 3-year Cx-like activity with/without BEMS. Some of them were corrected under the owners' approvals. The temperature and/or humidity setting, the energy loss with pump, and the energy medium temperature fluctuation from the DHC plant were analyzed in details for energy savings.

### Cx actions

- Design review
- Verification of sensors and actuators
- DHC contract renewal
- Tentative investigation
- Recommendation for DHC plant operation
- Regular meeting with owners and operators etc.

### Cx Recommendations

When BEMS is installed it better to utilize BEMS as a commissioning tool. It is very effective to do functional performance test.

## DEMONSTRATION SITE: SHINKAWA JAPAN

### Description of building: Shinkawa building

	☞ Location: TOKYO – JAPAN
	☞ Type of building: Office building
	☞ Year of construction: 1988 Winter -Renewal :2003
	☞ Size: 5400 m <sup>2</sup> (Heating & Cooling conditioned floor)
	☞ Contacts: <ul style="list-style-type: none"> <li>• K,KAMITANI <a href="mailto:kkamitani@tonets.co.jp">kkamitani@tonets.co.jp</a></li> </ul>

### Description of HVAC system

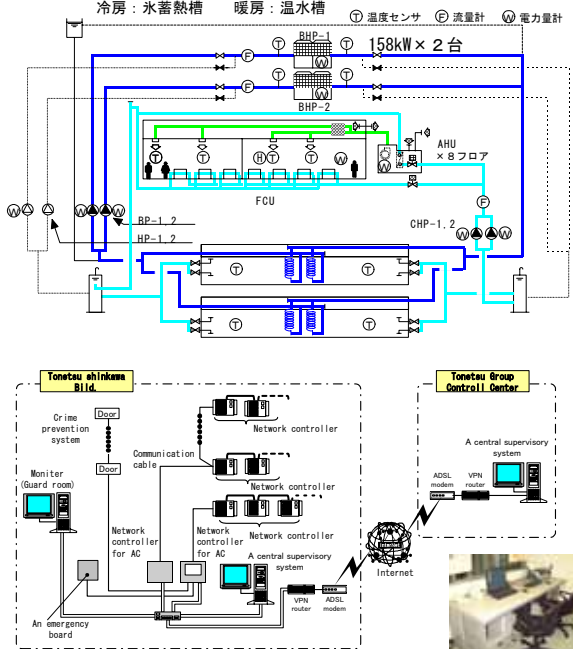
	<p><b>Plant level</b></p> <ul style="list-style-type: none"> <li>• 1 Air-Source Brine Heat Pump(158kW×2)</li> <li>• 2 Ice Thermal Storage Tank(64m<sup>3</sup>×2,IPF=8%) (Also used heating water in winter.)</li> <li>• 3 AHU/CAV on each floor FCU for perimeter zone.</li> <li>• 4 VVW system W/2-way control valves.</li> </ul> <p><b>Zone level</b></p> <ul style="list-style-type: none"> <li>• AHU &amp; Fan Coil Unit</li> </ul> <p><b>BEMS system</b></p> <ul style="list-style-type: none"> <li>• Brand: Original(EASY Net-1000)</li> <li>• Size: 800 points</li> <li>• Local controller: Original(EASY Net-10)</li> <li>• Supervisor: Design Insight</li> </ul>
--	--

### Commissioning project

<b>Objectives:</b>	<b>Renewal of BAS/BEMS and automatic controls</b> <ul style="list-style-type: none"> <li>• Evaluation and practice of commissioning</li> <li>• Energy saving</li> <li>• BEMS assisted tools</li> </ul>
<b>Type of Commissioning:</b>	<ul style="list-style-type: none"> <li>• Re Commissioning</li> </ul>
<b>Phases concerned:</b>	<ul style="list-style-type: none"> <li>• All phase</li> </ul>
<b>Target users:</b>	<ul style="list-style-type: none"> <li>• Building owners</li> </ul>

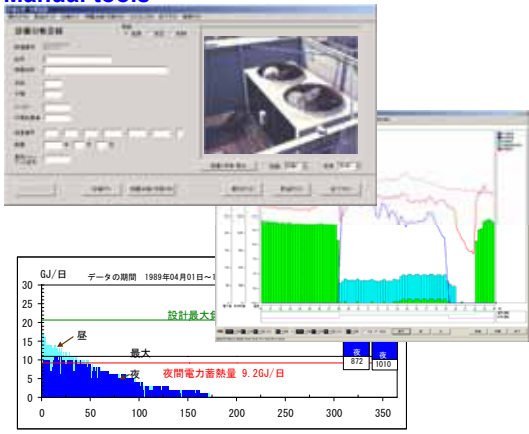
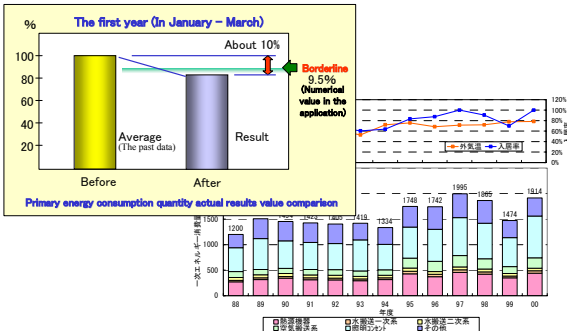

## Tools and methods tested

<p><b>Manual tools</b></p> 	<p><b>Commissioning process controls by MQC and check lists</b></p> <ol style="list-style-type: none"> <li>1. Equipment ledger</li> <li>2. Graphical analysis (Trend Graphic)</li> <li>3. Compare Results data with deal value</li> </ol>
<p><b>Automatic Cx Tools</b></p> <p>NEDO year end report</p> 	<p><b>BEMS assisted</b></p> <ol style="list-style-type: none"> <li>1. Primary energy Consumption analysis</li> <li>2. The comfortableness evaluation of the indoor environment</li> </ol>

## Practical experiences

### Users interview

Occupant Interview	Operator Interview
<ul style="list-style-type: none"> <li>• There is a cold place by the place with the hot place 【 indoor temperature 】 .</li> </ul>	<ul style="list-style-type: none"> <li>• The control of indoor temperature is difficult. (There are many partitions between the insides.)</li> <li>• Some technical equipments are not accessible</li> </ul>

### Cx actions

- The optimisation of the operation of the heat source system
- Control of saving energy of the building
- Installation review and verification of the sensors and actuators

### Cx Recommendations

1	Design Review	Collation confirmation with the design specification of the selection machine
2	Installation Review and Verification	While a tenant continued business activities, the verification of the process control and the control of execution was done to the condition that construction was carried out.
3	Installation Review and Verification with BEMS	The test verification of control logic
4	Measurement Verification with BEMS	<ul style="list-style-type: none"> <li>• Relative comparison with the standard thermometer of the temperature sensor</li> <li>• The performance verification of the machine ability</li> </ul>
5	Forced Response Testing and Analysis	An unusual value detection test
6	Documentation	Design Drawing、 Manufacture Specifications

## DEMONSTRATION SITE:

**Description of building:** TEPCO (Tokyo Electric Power Company) TACHIKAWA Branch

	☞ Location: Tachikawa, Tokyo, JAPAN
	☞ Type of building: Office
	☞ Year of construction: Jan. 2002 – Aug. 2003
	☞ Size: total/HVAC area: 16,765/8,981 m <sup>2</sup> Normal HVAC/ 24hs HVAC :6,334/ 2,647 m <sup>2</sup>
	☞ Contacts: Akihiko YOSHIKAWA <a href="mailto:yosizawa.akhiko@tepcoco.jp">yosizawa.akhiko@tepcoco.jp</a>

### Description of HVAC system

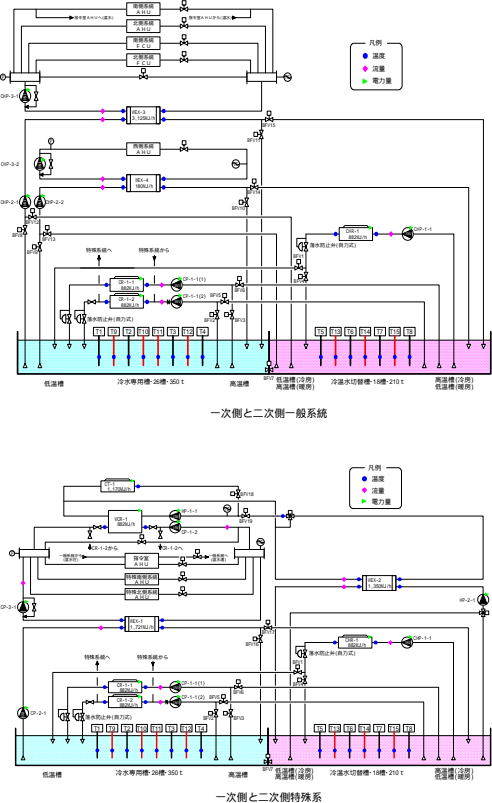
	<p><b>Plant level</b></p> <p>1) Generation:</p> <ul style="list-style-type: none"> <li>• 1 ASHP: (htg/clg cap) 245kW/300Iw with VVW</li> <li>• 2 ASHP: (clg cap) 245kW with VVW</li> <li>• 1 WCHP: (clg. cap.) 245kW</li> </ul> <p>2) Thermal Storage:</p> <ul style="list-style-type: none"> <li>• Chilled 350m<sup>3</sup> (chilled) 210m<sup>2</sup> (chilled/ warm)</li> </ul> <p><b>Zone level</b></p> <p>1) HVAC:</p> <ul style="list-style-type: none"> <li>• AHUs for each floor &amp; FCUs for perimeter zones</li> </ul> <p><b>BEMS system</b></p> <ul style="list-style-type: none"> <li>• Available</li> </ul>
--	--

### Commissioning project

<b>Objectives:</b>	Energy and Environmental Quality Control by Initial Commissioning
<b>Type of Commissioning:</b>	Initial Commissioning
<b>Phases concerned:</b>	Whole phase
<b>Target users:</b>	Building owners, in-house engineers and whole participants in addition



## Tools and methods developed

Manual tools		Development and employment of procedure documents																																	
<table border="1"> <tr> <th>要求文書名</th> <th>(A)</th> <th>(B)</th> <th>(C)</th> <th>(D)</th> <th>(E)</th> </tr> <tr> <td>要求記述項目</td> <td>必要文書・記述の有無</td> <td>同左内容 (必要に応じて記述)</td> <td>文書等の適不足 確認 :合格 x・不合格</td> <td>内容の妥当性 確認 :合格 x・不合格</td> <td>是正提案 (CA)</td> </tr> <tr> <td>大項目</td> <td></td> <td></td> <td></td> <td></td> <td></td> </tr> <tr> <td>中項目</td> <td></td> <td></td> <td></td> <td></td> <td></td> </tr> <tr> <td>細目</td> <td>(設計者による文書)</td> <td></td> <td></td> <td></td> <td>(発注者・設計者)</td> </tr> </table>	要求文書名	(A)	(B)	(C)	(D)	(E)	要求記述項目	必要文書・記述の有無	同左内容 (必要に応じて記述)	文書等の適不足 確認 :合格 x・不合格	内容の妥当性 確認 :合格 x・不合格	是正提案 (CA)	大項目						中項目						細目	(設計者による文書)				(発注者・設計者)					
	要求文書名	(A)	(B)	(C)	(D)	(E)																													
要求記述項目	必要文書・記述の有無	同左内容 (必要に応じて記述)	文書等の適不足 確認 :合格 x・不合格	内容の妥当性 確認 :合格 x・不合格	是正提案 (CA)																														
大項目																																			
中項目																																			
細目	(設計者による文書)				(発注者・設計者)																														
2) 検討書																																			
2)-1 空調システム検討書	有り	無し																																	
8 部分負荷時運転対応	有り	無し	x	x	検討指示																														
・容量制御範囲	有り	無し																																	
・システム対応	有り	無し																																	
・機器対応	有り	無し																																	
・その他	有り	無し																																	
概略機器仕様決定	有り	無し																																	
・空調機	有り	無し	x	x																															
・FCU	有り	無し																																	
・その他	有り	無し																																	

Automatic Cx Tools		Development and employment of documentation tools requisite at each phase				
						

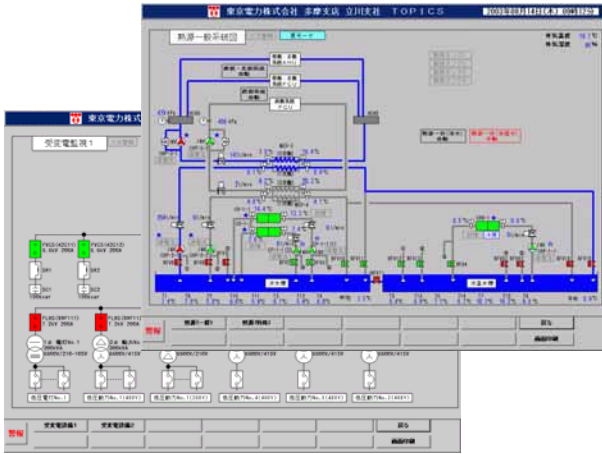
- Development and employment of procedure documents
- Development and employment of documentation tools requisite at each phase (Commissioning planning documents determine the framework of each phase of commissioning and, thus, has significant importance.)
- Development and employment of check-list sheets with grades of items which require the verification at each phase

- This BEMS treats operational data of heat source systems, pumps systems (including heat storage tanks), air-conditioning-units, and VAV systems.
- Automatic accumulation of data at intervals of 1 minute, 10 minute and 1 hour
- Automatic real-time graphs of the data and the part of calculated data which contribute to check the every-day operational conditions and even function performance tests.
- Coordination of the BEMS functions and forecast estimation system of heat-storage

## Practical experiences

### Users interview

Occupant Interview	Operator Interview
<ul style="list-style-type: none"> <li>mostly no troubles</li> </ul>	<ul style="list-style-type: none"> <li>up until now, no severe troubles</li> <li>heat storage operation has proceeded well.</li> </ul>

### Cx actions

- interview with the owner, designers and constructors.
- development and verification of documentation tools
- verification of construction conditions
- verification of TAB results
- execution of function performance tests
- operational data check assisted by BEMS

### Cx Recommendations

Manual	1	development procedure	Identification of purpose and scope of Cx, role and responsibilities of stakeholders, schedule, distributing information etc ( in FPT )
	2	documentation tools	development of documentation tools at each phase to organize systematically and to distribute information accurately
BEMS assisted	3	measurement	planning of measurement means to verify the owner's requested performance
	4	TAB	identification of TAB implementation items and prior check of the site, confirmation of acquiring the data at TAB and execution considering design intents
	5	function performance tests	prior check (confirming the acquisition of data)
	6	operation management	organizing documents to convey the design intention to operators

## DEMONSTRATION SITE: YAMATAKE RESEARCH CENTER JAPAN

### Description of building: Environmental Engineering Research Center of Yamatake

	☞ Location: Ootaku Tokyo – Japan
	☞ Type of building: Office and laboratories building
	☞ Year of construction: 1999-2000
	☞ Size: 1700 m <sup>2</sup> (conditioned floor )
	☞ Contacts: <ul style="list-style-type: none"> <li>• Kazuyasu Hamada : Hamada-kazuyasu@jp.yamatake.com</li> <li>• Makoto Tsubaki : Tsubaki-makoto@jp.yamatake.com</li> </ul>

### Description of HVAC system

	<p><b>Plant level</b></p> <ul style="list-style-type: none"> <li>• 1 air-cooled heat pump chiller: 15RT</li> <li>• Water thermal storage 60m<sup>3</sup></li> <li>• Secondary pump system</li> </ul> <p><b>Zone level</b></p> <ul style="list-style-type: none"> <li>• 1F;Heat pump package</li> <li>• 2F;under floor AHU constant volume</li> <li>• 3F;VAV AHU</li> <li>• 4F;Slub thermal storage system</li> </ul> <p><b>BEMS system</b></p> <ul style="list-style-type: none"> <li>• Brand: savic-net EV(Yamatake)</li> <li>• Size: points 3000pts</li> <li>• Local controller: AHU IDC (Yamatake) VAV IVC(Yamatake) Plant PMX-3(Yamatake)</li> </ul>
--	--

### Commissioning project

<b>Objectives:</b>	<ul style="list-style-type: none"> <li>• Owner's vision <ol style="list-style-type: none"> <li>1. Energy conservation, Reduction of Life cycle co<sub>2</sub></li> <li>2. Getting CX knowledge of general information through construction to operation phase as CX</li> <li>3. Open to public CX knowledge through SHASE</li> </ol> </li> </ul>
<b>Type of Commissioning:</b>	<ul style="list-style-type: none"> <li>• Initial Commissioning(including design CX)</li> </ul>
<b>Phases concerned:</b>	<ul style="list-style-type: none"> <li>• Though Construction phase to Operation Phase</li> <li>• On-going Cx is processing</li> </ul>
<b>Target users:</b>	<ul style="list-style-type: none"> <li>• Building Owner and operator, Maintenance personnel</li> </ul>

## Tools and methods tested

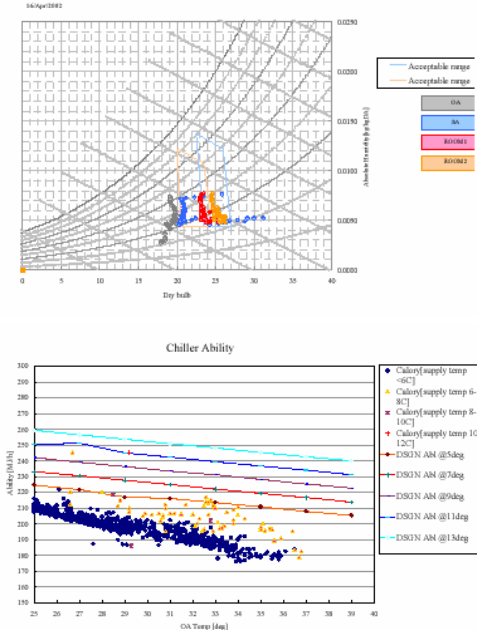
<p><b>Manual tools</b></p> 	<p><b>Project management(Check list, guideline etc)</b></p> <ul style="list-style-type: none"> <li>Maintenability check list</li> <li>Functional specification document for Building Automation System ,etc</li> </ul> <p><b>Functional performance test procedure</b></p> <p>&lt;Component level&gt;</p> <ul style="list-style-type: none"> <li>DDC engineering tool(as data logger 1sec interval)</li> <li>Measurement for every input and output of equip</li> </ul> <p>&lt;Building level&gt;</p> <ul style="list-style-type: none"> <li>BEMS data logging(1min interval)</li> <li>BEMS grapf tool</li> </ul>
--	---

## Practical experiences

### Users interview

Occupant Interview	Operator Interview
	<ul style="list-style-type: none"> <li>Enough information about Owner's and Designer's intent</li> </ul>

### Cx actions

- Design review, collect and check of the available documents
- Confirmation of OPR
- Installation review and verification of the HVAC equipment and the components of BEMS like sensors and actuators
- TAB verification
- FPT implementation
- Operator training
- Documenting: FPT test results, performance of AHUs and evaluation of cost-benefit of commissioning

### Cx Recommendations

Manual	1	Design Review	Check control logic, sensor placement and sensor accuracy with design documents Detail set-point and value should be defined provided by OPR as possible
	2	TAB Verification	Conduct a field inspection to determine installed characteristics of the equipment including condition and maintainability
BEMS assisted	3	Control logic verification	Verify mismatch between the control logic and design documents
	4	Forced Response Testing and Analysis	Analyse performance of the equipment with the Commissioning tools.
	5	FPT	The detail procedure of FPT authorized by the CA should be defined The result of the integrated control test should be judged by the CA
	6	Documentation	Document the result of the commissioning analysis
	7	Training	Training should have conducted by the CA and the design team

## DEMONSTRATION SITE: O-HOUSE JAPAN

### Description of building: Residential building, O-House

	☞ Location: Hyogo – Japan
	☞ Type of building: Residential building
	☞ Year of construction: 1996
	☞ Size: 151 m <sup>2</sup> (60 m <sup>2</sup> conditioned floor and heated floor)
	☞ Contacts: <ul style="list-style-type: none"> <li>• S. Hokoi : hokoi@archi.kyoto-u.ac.jp</li> <li>• N Nakahara : nob_naka@sa.starcat.ne.jp</li> <li>• H. Miura : be.hisashi@archi.kyoto-u.ac.jp</li> </ul>

### Description of HVAC system

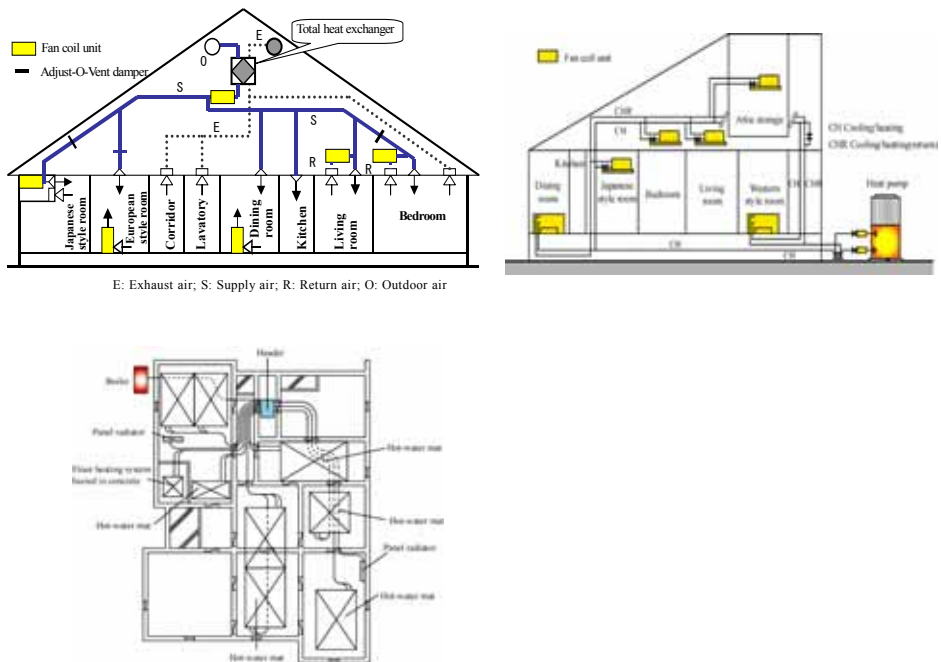
 <p style="font-size: small; text-align: center;">E: Exhaust air; S: Supply air; R: Return air; O: Outdoor air</p>	<p><b>Plant level</b></p> <ul style="list-style-type: none"> <li>• 1 Heat-pump chiller: 6 kW</li> <li>• 1 gas boiler: 10kW</li> </ul> <p><b>Zone level</b></p> <ul style="list-style-type: none"> <li>• Floor Heating Panel (First Floor)</li> <li>• Fan Coil Unit</li> </ul> <p><b>BEMS system</b></p> <ul style="list-style-type: none"> <li>• none</li> <li>• Supervisor: Design Insight</li> </ul>
---	--

### Commissioning project

<b>Objectives:</b>	<p><b>Identify and clarify the problems for thermal comfort and energy</b></p> <ul style="list-style-type: none"> <li>• Evaluation of the occupant's thermal comfort</li> <li>• To check whether the energy is wasted and to improve energy consumption</li> <li>• To clarify the residents' behaviour and operability of equipments</li> </ul>
<b>Type of Commissioning:</b>	<ul style="list-style-type: none"> <li>• Initial Commissioning</li> </ul>
<b>Phases concerned:</b>	<ul style="list-style-type: none"> <li>• All phases</li> </ul>
<b>Target users:</b>	<ul style="list-style-type: none"> <li>• Residents</li> </ul>

## Tools and methods tested

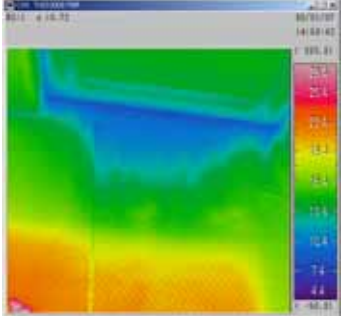
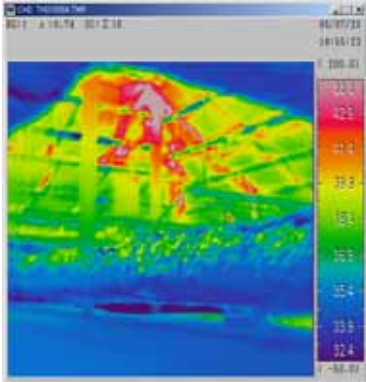
<p><b>Manual tools</b></p> 	<p><b><u>Manual Cx for air supply and exhausted airflow</u></b></p> <ol style="list-style-type: none"> <li>1. Are proper airflow routes realized according to design?</li> <li>2. Is the room temperature distribution uniform during heating/cooling period</li> </ol>
<p><b>Manual Cx Tools</b></p> 	<p><b><u>Manual Cx for insulation performance</u></b></p> <ol style="list-style-type: none"> <li>1. Is insulation installed as specified according to design intent</li> <li>2. Is there an insulation deficit?</li> <li>3. Are there any metal frame/fittings that act as a heat bridge ?</li> </ol>

## Practical experiences

### Users interview

Occupant Interview	Operator Interview
<ul style="list-style-type: none"> <li>• The control panel is too difficult to operate, since there are too many switches to be adjusted.</li> <li>• The bedroom temperature becomes sometimes too cold or too hot.</li> </ul>	<ul style="list-style-type: none"> <li>• None (because no operators)</li> </ul>

### Cx actions

- Measurement of airflow rates at the inlets and outlets
- Comparison of measured and calculated ventilation rates between rooms
- Check of there is insulation deficit and/or heat bridge
- Testing of heat supply by floor heating system and air-conditioning systems
- Documenting: test results, performance of central air-conditioning system

### Cx Recommendations

1	Project & Planning Phases	The concept of commissioning should be prevailed widely between builders, energy suppliers and engineers.
2	Construction Phase	Good information transfer by well-experienced staff is needed. An in-company inspection should be checked by other objective means.
3	Acceptance Phase	The commissioning in this phase should be done thoroughly , since the problems in the following phases might be avoided.
4	Operation Phase	Infrared thermo-camera is very effective in checking the insulation in hidden areas such as the inside of the walls or crawl space. Simple measuring method of overall heat transfer coefficient is required. Appropriate and simple method is required to measure airflow rates through the small openings such as door undercut. A simpler method should be developed for measuring water temperature and heat flow rate, since measurements are difficult. Simple calculation of heat balance provides a lot of information.



## DEMONSTRATION SITE: OFFICE BUILDING THE NETHERLANDS

### Description of building: Postbank office building

	☞ Location: Amsterdam – The Netherlands
	☞ Type of building: Office building
	☞ Year of construction: 2000
	☞ Size: 6,735 m <sup>2</sup> , 600 persons
	☞ Contacts: <ul style="list-style-type: none"> <li>• H. C. Peitsman : <a href="mailto:h.peitsman@bouw.tno.nl">h.peitsman@bouw.tno.nl</a></li> <li>• P.E. Elkhuisen : <a href="mailto:p.elkhuisen@bouw.tno.nl">p.elkhuisen@bouw.tno.nl</a></li> <li>• J.E. Scholten : <a href="mailto:j.scholten@bouw.tno.nl">j.scholten@bouw.tno.nl</a></li> </ul>

### Description of HVAC system

	<b>Plant level</b> <ul style="list-style-type: none"> <li>• Constant air volume system (CAV)</li> <li>• Humidity of supply air</li> <li>• Heat recovery</li> </ul>
	<b>Zone level</b> <ul style="list-style-type: none"> <li>• Radiators</li> <li>• Cooling in the ceiling</li> <li>• Call-center</li> <li>• Meeting rooms</li> </ul>
	<b>BEMS system</b> <ul style="list-style-type: none"> <li>• Johnson Controls</li> <li>• Local controller: Johnson Controls</li> <li>• Supervisor: Johnson Controls</li> </ul>

### Commissioning project

<b>Objectives:</b>	<b>Solve occupant complaints concerning the thermal comfort</b> <ul style="list-style-type: none"> <li>• Evaluation of the AHU' s Heating-/ Cooling curve performance</li> <li>• Installation of sub meters</li> <li>• Testing and Adjusting of the control systems</li> </ul>
<b>Type of Commissioning:</b>	<ul style="list-style-type: none"> <li>• Re Commissioning</li> </ul>
<b>Phases concerned:</b>	<ul style="list-style-type: none"> <li>• Operating phase</li> </ul>
<b>Target users:</b>	<ul style="list-style-type: none"> <li>• 600 building users</li> </ul>

## Tools and methods developed

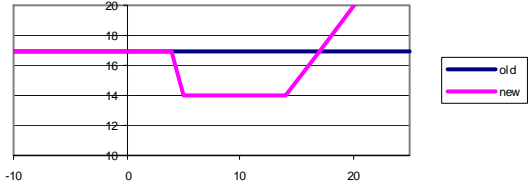
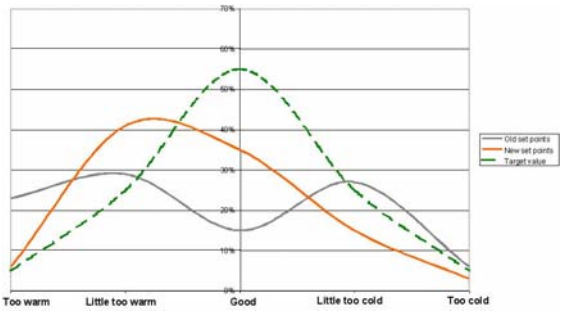
<p><b>Old en new heating curve</b></p> 	<p><b><u>Set points of the Heating curve Air Handling Unit</u></b></p> <p>In the old situation the set point of the heating curve was fixed on 17 °C. Based on the new calculations with taken into account of real building loads and building physics the following set points were found:</p> <ul style="list-style-type: none"> <li>• transition area 5 till 17 °C</li> <li>• set point first test period 14 °C</li> <li>• final set point 13°C</li> </ul>
<p><b>Comfort level before and after new set points</b></p> 	<p><b><u>The Comfort level</u></b></p> <p>The figure presents the theoretical optimal comfort perception (green line) in the building and the real situation in the building based on the outcome of an inquiry by the building users. In the old situation (grey line) the fraction of people who are satisfied (see 'good') was 15 %. After retuning the set points, the fraction of people who are satisfied (see 'good') increased from 15 % till 35 % (orange line).</p> <p>A further optimisation to reach the maximum satisfaction of comfort was not possible due to the fact that lower supply air temperature means more draught complains.</p>

## Practical experiences

### Users interview

Occupant Interview	Operator Interview
<ul style="list-style-type: none"> <li>• Offices are too warm in mid-season</li> <li>• Office are too cold in winter</li> </ul>	<ul style="list-style-type: none"> <li>• Complaints of comfort in mid season and winter</li> <li>• Happy with the approach of TNO</li> <li>• Happy to solve the comfort complains</li> </ul>

### Cx actions

- Occupant and operator interviews
- Design review, collect and check of the available documents
- Air Handle Unit review and verification of the set points
- Retuning of the AHU set points
- Documenting: test results, performance of AHU

### Cx Recommendations

Manual	1	Design Review	Check control logic, sensor placement and sensor accuracy with design documents
	2	Installation Review and Verification	Conduct a field inspection to determine installed characteristics of the equipment including condition and sensor availability (real location)
BEMS assisted	3	Installation Review and Verification with BEMS	Verify mismatch between BEMS control logic and design documents
	4	Measurement Verification with BEMS	Define measurements to log with BEMS, evaluate data for compliance
	5	Forced Response Testing and Analysis	Analyse performance of the system.
	6	Documentation	Document the result of the commissioning analysis



## DEMONSTRATION SITE: OKSTAD SKOLE, TRONDHEIM

### Description of building: Primary school, Trondheim, Norway

	☞ Location: Trondheim, Middle Norway
	☞ Type of building: Primary school
	☞ Year of construction: 1997
	☞ Size: 1600 m <sup>2</sup> (heated floor)
	☞ Contacts: <ul style="list-style-type: none"> <li>• V Novakovic : <a href="mailto:vojislav.novakovic@ntnu.no">vojislav.novakovic@ntnu.no</a></li> <li>• J Stang : <a href="mailto:jacob.stang@sintef.no">jacob.stang@sintef.no</a></li> <li>• J N Holst : <a href="mailto:johnny.n.holst@ntnu.no">johnny.n.holst@ntnu.no</a></li> </ul>

### Description of HVAC system

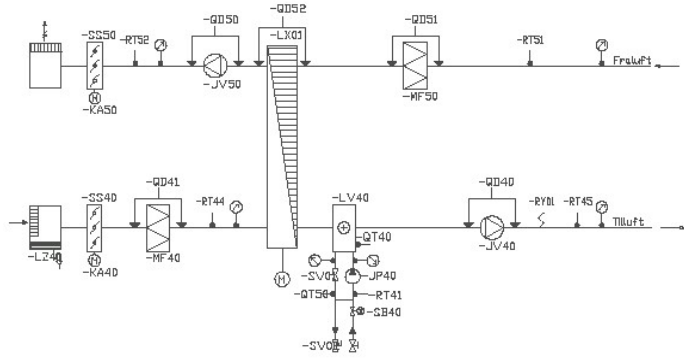

Annual energy consumption (weather normalized)

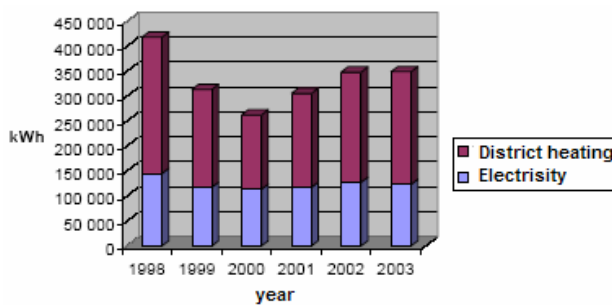

Year	District heating	Electricity	Total
1998	270,000	150,000	420,000
1999	200,000	120,000	320,000
2000	150,000	120,000	270,000
2001	180,000	130,000	310,000
2002	200,000	140,000	340,000
2003	230,000	140,000	370,000

**Plant level**

- Substation for district heating – 100kW
- 3 Air Handling Units, Constant Air Volume (CAV), 15000 m<sup>3</sup>/h:
  - AHU1 (Office space), heating coil
  - AHU2 (Classrooms), heating coil
  - AHU3 (Gymnasium), heating coil

**Zone level**

- Radiators (Offices and classrooms)
- Floor heating (Bathroom at the gymnasium)

**BEMS**

- Brand: Honeywell
- Size: 150 points
- Local controller: EMC
- Supervisor: XBS

### Commissioning project

<b>Objectives:</b>	<p><b>Solve problems reported by the owner:</b></p> <ul style="list-style-type: none"> <li>• Increasing energy consumption over the last four years</li> <li>• Occupant complaints concerning the thermal comfort</li> </ul> <p><b>Provide demonstration site for application of commissioning:</b></p> <ul style="list-style-type: none"> <li>• Comparison between Continuous Commissioning<sup>SM</sup> and traditional Norwegian energy efficiency methods</li> </ul>
<b>Type of Commissioning:</b>	<ul style="list-style-type: none"> <li>• Re Commissioning</li> </ul>
<b>Phases concerned:</b>	<ul style="list-style-type: none"> <li>• Operating phase</li> </ul>
<b>Target users:</b>	<ul style="list-style-type: none"> <li>• Building owner (Municipality of Trondheim, Real estate department)</li> </ul>

## Tools and methods applied

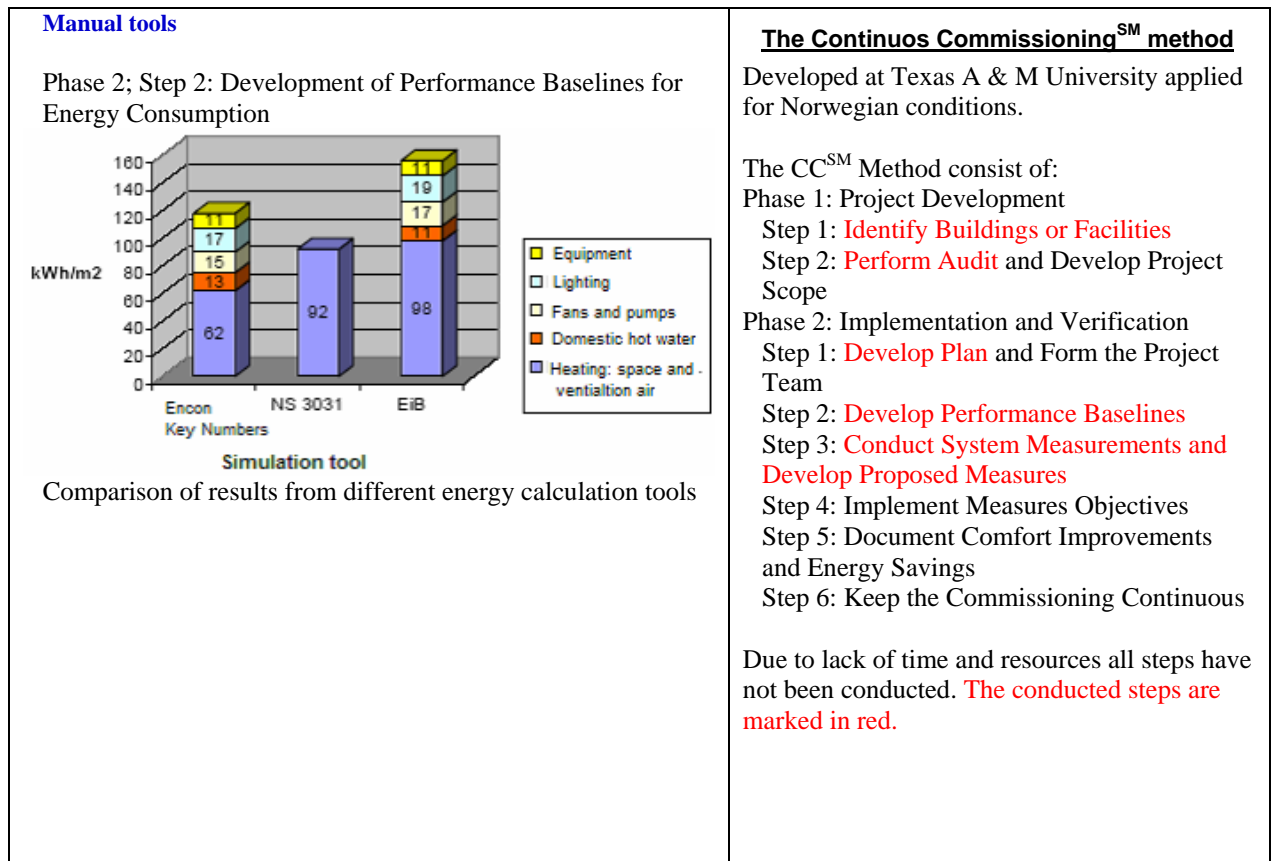

## Practical experiences

### Users interview

Occupant Interview	Operator Interview
<ul style="list-style-type: none"> <li>Bad indoor air quality in the offices (reported by 64% of respondents)</li> <li>Offices are too hot in periods with intensive use (reported by 50% of respondents)</li> <li>Classrooms in one part of the building are too cold in winter (reported by 43% of respondents)</li> </ul>	<ul style="list-style-type: none"> <li>Some necessary appliances was not proposed by designer (drying cupboard, school milk refrigerator) – cause large internal gains</li> <li>Two offices have often to high temperatures</li> <li>Solar sensor was not correctly installed</li> </ul>

### Cx actions

- Occupant and operator interviews
- Design review, collect and check of the available documents
- Installation review and check of the sensors and actuators
- Measurement of air-flow rates and indoor environment parameters (temperature, humidity, CO<sub>2</sub>)
- Development of performance baselines for energy consumption

### User experience

There are only small differences between the CC<sup>SM</sup> method and the traditional Norwegian energy efficiency methods. The development of the Norwegian methods over time has been motivated by problems obtained in different phases of energy efficiency scheme. It seems that the CC<sup>SM</sup> is more extensive than the Norwegian methods.

The main benefits in the CC<sup>SM</sup> method compared to the Norwegian methods are:

- The whole process is covered in one method
- The involvement of the in-house technicians are better described throughout the process
- The emphasis on indoor climate is consistent throughout the whole process.

## DEMONSTRATION SITE: THE KATSAN BUILDING SWEDEN

### Description of building: Office building with innovative HVAC-system



Location: Stockholm, Sweden

Type of building: Office (HQ White Arkitekter)

Year of construction: 2002-2003.

Size: 6700 m<sup>2</sup>

Contact persons:

Pär Carling [par.carling@af.se](mailto:par.carling@af.se)

Per Blomberg [per.blomberg@af.se](mailto:per.blomberg@af.se)

### Description of HVAC system

- ✓ Entire façade of glass
- ✓ Ventilation: Centralized AHU 8m<sup>3</sup>/s, VAV-system, liquid coupled heat recovery
- ✓ Primary heating: District heating
- ✓ Secondary heating: Convectors
- ✓ Primary cooling: Sea water
- ✓ Secondary cooling: Slab-cooling system and cooling beams
- ✓ BEMS: Centralized, network based on LON technology

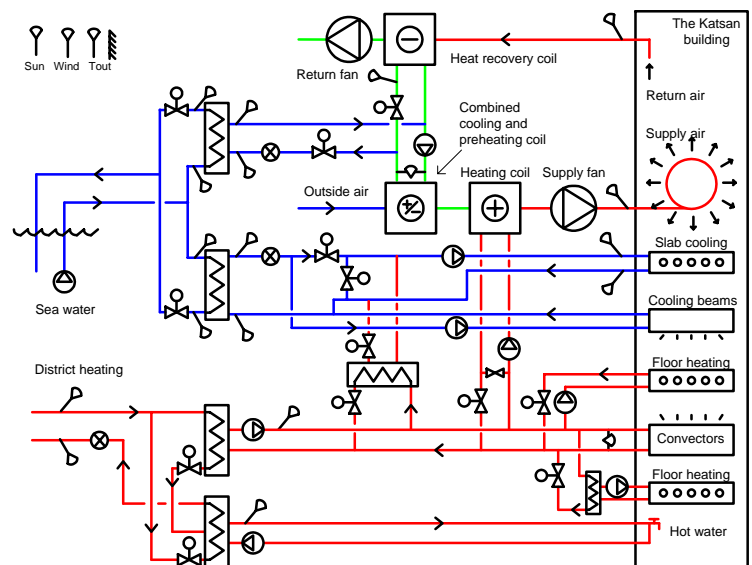

### Commissioning project

#### Objectives

- ✓ Design phase: Verify performance requirements through simulation.
- ✓ Post-acceptance phase: Verify performance through extensive measurements.
- ✓ Building process: Examine how simulation model may support building commissioning.

**Type:** Initial commissioning.

**Phase:** Pre-design to one year after completion.

**Target users:** HVAC designers.

## Tool developed and methods tested

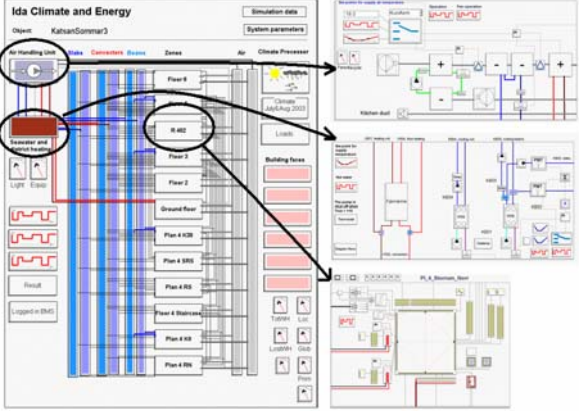
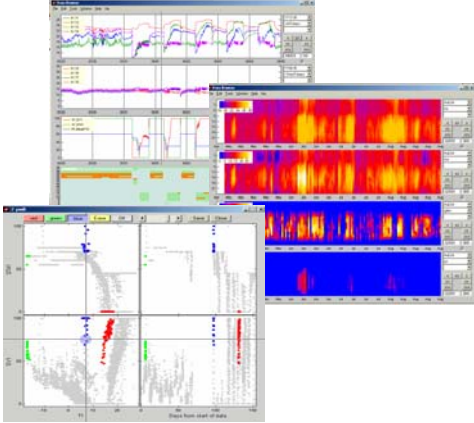
<p><b>Method</b></p> 	<p><b>Simulation-aided Commissioning</b></p> <ol style="list-style-type: none"> <li>1. Design a detailed whole-building simulation model for support of system selection and design</li> <li>2. Refine the model throughout the building process and use it to check changes</li> <li>3. Use the model to test performance during design conditions in the acceptance phase</li> <li>4. Use model as a reference to detect deviations and optimise performance.</li> </ol> <p><b>BEMS-assisted seasonal testing</b></p> <ol style="list-style-type: none"> <li>1. Extensive measurements through the BEMS (180 points)</li> <li>2. Visualization and analysis with custom-designed tool, Pia</li> <li>3. Generate report to provide feed-back to architect, HVAC-designer, operational staff and building owner.</li> </ol>
<p><b>Visualisation tool</b></p> 	<p><b>Custom-designed visualisation tool for building and HVAC-analysis, Pia</b></p> <ul style="list-style-type: none"> <li>✓ Large amounts of data</li> <li>✓ Compare simulations and measurements</li> <li>✓ Quick browsing</li> <li>✓ Synchronised graphs</li> <li>✓ Hair cross simplifies comparison of transients</li> <li>✓ Visual pattern recognition using carpet plots</li> <li>✓ PmBrush high-lights outliers</li> <li>✓ Expert rules may be implemented</li> <li>✓ Flexibility of Matlab</li> </ul>

## Practical experiences

The BEMS-assisted testing in combination with the visualisation tool proved to be fruitful. The energy and HVAC-performance of the building was easily communicated to both inexperienced people and to the HVAC-designers involved in the project. Several hidden deviations that severely influenced the energy performance were detected.

The simulation-aided commissioning shows a significant potential for supporting the improvement of building performance. However the model development was time-consuming. In order to reach cost-effectiveness the approach needs to be streamlined.

## DEMONSTRATION SITE: KISTA ENTRÉ SWEDEN

### Description of building: Modern office building

	☞ Location: Kista outside Stockholm – Sweden
	☞ Type of building: Office building
	☞ Year of construction: 2000-2002
	☞ Size: 46 000 m <sup>2</sup>
	☞ Contacts: <ul style="list-style-type: none"> <li>• Per Isakson: per.isakson@byv.kth.se</li> <li>• Pär Carling: par.carling@af.se</li> </ul>

### Description of HVAC system

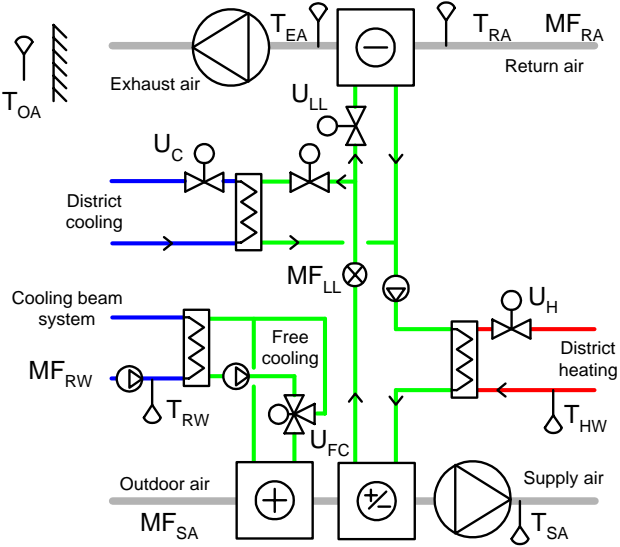
	<p><b>Plant level:</b></p> <ul style="list-style-type: none"> <li>✓ District heating.</li> <li>✓ District cooling.</li> <li>✓ Three centralized AHU, largest 50 m<sup>3</sup>/s. Liquid coupled heat recovery.</li> </ul> <p><b>Zone level:</b></p> <ul style="list-style-type: none"> <li>✓ Convectors</li> <li>✓ Cooling beams.</li> </ul> <p><b>BEMS-system:</b></p> <ul style="list-style-type: none"> <li>✓ Centralized BEMS (TAC-Vista)</li> <li>✓ Local controllers (TAC-Xenta)</li> <li>✓ Lon Works</li> </ul>
--	--

### Commissioning project

<b>Objectives</b>	<ul style="list-style-type: none"> <li>✓ Determine the function and the performance of the AHU.</li> <li>✓ Explore the possibilities of using detailed simulation model.</li> <li>✓ Support evaluation of seasonal test by visualisation of measured performance</li> </ul>
<b>Commissioning type</b>	✓ Initial and On-going Commissioning
<b>Phases concerned</b>	✓ Hand over, the period covered by guarantee, and operation
<b>Target users</b>	✓ Building owners, maintenance and operating personnel

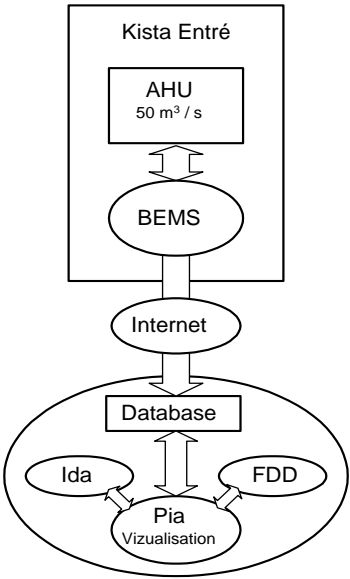
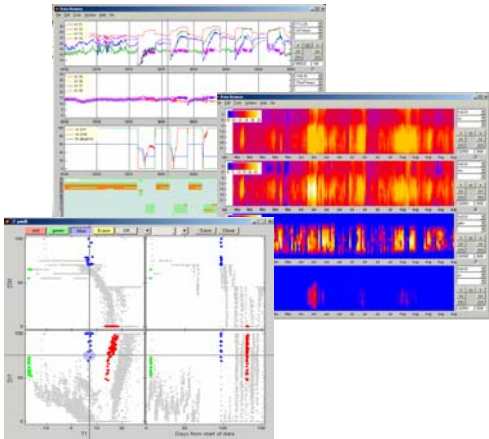

## Tools and methods developed

<p><b>Methods</b></p> 	<p><b>Model-based functional performance testing</b></p> <ol style="list-style-type: none"> <li>1. Develop simulation model of AHU in IDA ICE</li> <li>2. Calibrate component models with available data</li> <li>3. Connect system model to measured boundaries</li> <li>4. Compare measured and modelled output</li> <li>5. Perform functional tests with model to explore function and optimize performance</li> </ol> <p><b>BEMS-assisted seasonal testing</b></p> <ol style="list-style-type: none"> <li>1. Extensive measurements through the BEMS (500 points)</li> <li>2. Data transferring via Internet</li> <li>3. Visualization and analysis with custom-designed tool, Pia</li> <li>4. Generating reports to support seasonal evaluation meetings and high-light deviations</li> </ol>
<p><b>Visualisation tool</b></p> 	<p><b>Custom-designed visualisation tool for building and HVAC-analysis, Pia</b></p> <ul style="list-style-type: none"> <li>✓ Large amounts of data</li> <li>✓ Quick browsing</li> <li>✓ Synchronised graphs</li> <li>✓ Hair cross simplifies comparison of transients</li> <li>✓ Visual pattern recognition using carpet plots</li> <li>✓ PmBrush high-lights outliers</li> <li>✓ Expert rules may be implemented</li> <li>✓ Flexibility of Matlab</li> </ul>

## Practical experiences

The model-based functional performance test identified a measure to increase the heat recovery efficiency with about 8 percentage units in the largest AHU. The approach is promising but time-consuming and the work needs to be streamlined.

The BEMS-assisted seasonal tests revealed about 40 anomalies that otherwise most likely had stayed unknown. The real estate owner is enthusiastic and wants to implement the approach in another four buildings during the coming year.

## DEMONSTRATION SITE: OAKLAND FEDERAL BUILDING

### Description of building: Government office building

	☞ Location: Oakland downtown – California
	☞ Type of building: Office building
	☞ Year of construction: 1994
	☞ Size: 110,000 m <sup>2</sup>
	☞ Contacts: <ul style="list-style-type: none"> <li>• Philip Haves: <a href="mailto:phaves@lbl.gov">phaves@lbl.gov</a></li> <li>• Mary Ann Piette: <a href="mailto:MAPiette@lbl.gov">MAPiette@lbl.gov</a></li> <li>• Peng Xu: <a href="mailto:pxu@lbl.gov">pxu@lbl.gov</a></li> </ul>

### Description of HVAC system

	<p><b>Plant level</b></p> <ul style="list-style-type: none"> <li>• Three chillers</li> <li>• One gas boiler</li> <li>• 4 Air Handling Units, dual duct Variable Air Volume (VAV):</li> </ul> <p><b>Zone level</b></p> <ul style="list-style-type: none"> <li>• VAV with perimeter heating</li> </ul> <p><b>BEMS system</b> Johnson Controls Metasys</p>
--	---

### Commissioning project

<b>Objectives:</b>	<ul style="list-style-type: none"> <li>• Solve occupant complaints concerning the thermal comfort</li> <li>• Evaluation of the HVAC performance</li> <li>• Identify energy saving opportunities</li> <li>• Determine energy saving of various suggested measures</li> </ul>
<b>Type of Commissioning:</b>	<ul style="list-style-type: none"> <li>• Re-Commissioning</li> </ul>
<b>Phases concerned:</b>	<ul style="list-style-type: none"> <li>• Operating phase</li> </ul>
<b>Target users:</b>	<ul style="list-style-type: none"> <li>• Facility manager</li> </ul>



## Tools and methods developed

<p><b>Manual tools</b></p>	<p><b><u>Rebuild American Series – Building commissioning guide</u></b></p> <p><b><u>International Performance Measurement and Verification Protocol (IPMVP)</u></b></p> <p><b><u>Continuous commissioning guide for building energy systems</u></b></p>
<p><b>Automatic Cx Tools</b></p>	<p><b><u>HVAC fault detection and diagnosis tool (LBNL)</u></b></p>

## Practical experiences











### Cx Measures

#	Description	Elec cost saving \$	Gas cost Saving \$	Total cost saving \$	Cost Estimate	Payback Estimate (yr)
1	Relief Dampers – reverse flow	\$0	\$6,085	\$6,085	\$1-2K	0.1-0.3
2	Inaccurate Sensor Locations - SA Sensors	\$26,479	\$0	\$26,479	\$2-4K	0.1-0.2
3	Inaccurate Sensor Locations - MA Sensors	\$0	\$753	\$753	\$4-8K	5-10
4	Excessive Static Setpoint – Optimize	\$16,614	\$0	\$16,614	\$4-8K	0.2-0.5
5	Economizer damper repair	\$12,534	\$0	\$12,534	\$5-10K	0.4-0.8
6	Hot Deck reverse flow	\$3,273	\$1,243	\$4,516	\$1.5-3k	0.3-0.7
	Total	\$58,900	\$8,081	\$66,981	\$17-35K	0.3-0.5

## APPENDIX 3: PARTICIPANTS TO THE ANNEX

### Participants to the Annex

 Y. Akashi akashi@beel.arch.kyushu-u.ac.jp	 P. Andre andre@ful.ac.be	 O. Bauman o.baumann@ebert-ing-muenchen.de	 D. Bornside david.bornside@siemens.com	 P. Carling par.carling@af.se	 N. Castro natascha.castro@nist.gov	 S.H. Cho shcho@kier.re.kr
 D. Choinière dchoinie@nrcan.gc.ca	 JM Chuard chuard@enerconom.ch	 D. Claridge claridge@esl.tamu.edu	 B. Cléménçon bernard.clemencion@edf.fr	 M. Corsi mcorsi@NRCan.gc.ca	 D. Dodds ddodds@ch2m.com	 J. Eriksson jorgen.eriksson@af.se
 T. Haas thaas@peci.org	 K. Hamada hamadam-kazuyqsu@jp.yamatake.co	 P. Haves Phaves@lbl.gov	 T. I. Hoel tor.i.hoel@ntnu.no	 S. Hokoi hokoi@archi.kyoto-u.ac.jp	 J. Holst johnny.n.holst@ntnu.no	 J. House jhouse@energy.iastate.edu
 P. Isakson poi@bim.kth.se	 A. Iwamae ai@arch.kindai.ac.jp	 M. Jandon jandon@cstb.fr	 T. Kalema timo.kalema@tut.fi	 K. Kamitani kkamitani@tonets.cp.jp	 H. Keranen hannu.keranen@tut.fi	 P. Lacote
 C. Laruelle celine.laruelle@elyo.fr	 J. Lebrun j.lebrun@ulg.ac.be	 Z. Magyar zmagyar@invitel.hu	 M. Miyata myt_masato@ybb.ne.jp	 O. Morisot olivier.morisot@elyo.fr	 Y. Nakada yuuji.nakada@toshiba.co.jp	 N. Nakahara pl.nobuo.nakaa@kfx.biglobe.ne.jp
 V. Novakovic vojislav.novakovic@ntnu.no	 T. Odajima odajima.takao@takenaka.co.jp	 I. Ohta Isamu_Ohta@home.misawa.co.jp	 H. Onojima onojima.hajime@obayashi.co.jp	 P. Op't Veld p.optveld@chm.chri.nl	 S. Paiho satu.paiho@vtt.fi	 H. Peitsman h.peitsman@bouw.tno.nl

 <p>J Pietilainen jorma.pietilainen@vtt.fi</p>	 <p>MA Piette mapiette@lbl.gov</p>	 <p>P Ramsak p.ramsak@seinternovem.nl</p>	 <p>T Salsbury timothy.l.salsbury@jci.com</p>	 <p>K. Satou satou@bpc-jp.com</p>	 <p>M. Shioya shioyam@kajima.com</p>	 <p>J. Stang jacob.stang@sintef.no</p>
 <p>M. Tsubaki tsubaki-makoto@jp.yamatake.com</p>	 <p>H Vaezi Nejad vaezi@cstb.fr</p>	 <p>B Viaud benedicte.viaud@edf.fr</p>	 <p>JC Visier visier@cstb.fr</p>	 <p>F. Wang fuwang@archi.kyoto-u.ac.jp</p>	 <p>S. Wang beswwang@polyu.edu.hk</p>	 <p>M. Yamahha yamaha@isc.chubu.ac.jp</p>
 <p>H. Yoshida nori@archi.kyoto-u.ac.jp</p>						

## Participating countries and organisations

Ten countries participated to the Annex program as full participants

- Belgium
  - Fondation Universitaire Luxembourgeoise (F.U.L.)
  - Université de Liège, Laboratoire Thermodynamique
- Canada
  - EDRL
  - Natural Resources Canada
- Switzerland
  - Enerconom ag
- Germany
  - Ebert-Ingenieure
- France
  - CSTB
  - EDF
  - Elyo Cylergie
- Finland
  - Tampere University of Technology
  - VTT
- Japan
  - BPC
  - Chubu University
  - Kajima Corporation
  - Kyoto University
  - Kyushu University
  - Misawa Homes Co., Ltd.
  - Nestec
  - Obayashi Corporation
  - Sekisui House Ltd
  - Takenaka Corporation
  - Tonets
  - Toshiba Corporation
  - Yamatake corporation
- Norway
  - NTNU
  - SINTEF
- Sweden
  - AF-Installation
  - KTH Royal Institut of Technology
  - SP
- USA
  - CH2M Hill
  - Iowa Energy Centre
  - Johnson Control, Inc.
  - Lawrence Berkeley National Laboratory
  - National institue for standard and technologies
  - Portland Energy Conservation Inc.
  - Siemens Building Technology
  - Texas A & M University

Four countries joined the project as observers:

- Hong Kong /PRC - The Hong Kong Polytechnic University
- Hungary - Comfort Consulting Ltd
- Korea - KIER
- The Netherlands - Cauberg-Huygen  
- NOVEM  
- TNO

**The work was managed by CSTB (France).**

## Acknowledgements

The work presented in this document was funded by:

### **Belgium:**

**Canada:** PERD, Public Works and Governmental Services Canada, Natural Resources Canada

**Finland:** TEKES (public funder); ARE Oy; AirIx Oy; City of Helsinki; City of Pori; Comsel System Oy; Construction Department of Finnish Army; JP-Rakennus Oy; Lonix Oy; Motiva Oy; Optiplan Oy; Senaatti Oy; Skanska Oy; VVO Oy; YIT - Huber.

**France:** Agence De l'Environnement et de la Maitrise de l'Energie, Centre Scientifique et Technique du Bâtiment, Electricité De France, Ministère de l'Equipeement, des Transports et du Logement.

**Germany:** Federal Ministry of Economics and Labor (BMWA) funding identification 032746D

### **Japan:**

### **Norway:**

- The joint Strategic University Program and Strategic Institute Program: Smart Energy Efficient Buildings; Norwegian University of Science and Technology and SINTEF Energy Research.
- The Research Council of Norway

### **Sweden:**

**Switzerland:** Swiss Federal Office Of Energy

**USA:** California Energy commission, Johnson Control Inc., National Institute of Standards and Technology, Siemens Building Technologies, Texas AM University, US Department of Energy.

**Hong Kong:** PRC

### **Hungary:**

**Korea:** KIER

**The Netherlands:** Novem, TNO

## **International Energy Agency**

The International Energy Agency (IEA) was established in 1974 within the framework of the Organisation for Economic Co-operation and Development (OECD) to implement an international energy programme. A basic aim of the IEA is to foster co-operation among the twenty-four IEA participating countries and to increase energy security through energy conservation, development of alternative energy sources and energy research, development and demonstration (RD&D).

### **Energy Conservation in Buildings and Community Systems**

The IEA sponsors research and development in a number of areas related to energy. The mission of one of those areas, the ECBCS - Energy Conservation for Building and Community Systems Programme, is to facilitate and accelerate the introduction of energy conservation, and environmentally sustainable technologies into healthy buildings and community systems, through innovation and research in decision-making, building assemblies and systems, and commercialisation. The objectives of collaborative work within the ECBCS R&D program are directly derived from the on-going energy and environmental challenges facing IEA countries in the area of construction, energy market and research. ECBCS addresses major challenges and takes advantage of opportunities in the following areas:

- exploitation of innovation and information technology;
- impact of energy measures on indoor health and usability;
- integration of building energy measures and tools to changes in lifestyles, work environment alternatives, and business environment.

### **The Executive Committee**

Overall control of the program is maintained by an Executive Committee, which not only monitors existing projects but also identifies new areas where collaborative effort may be beneficial. To date the following projects have been initiated by the executive committee on Energy Conservation in Buildings and Community Systems (completed projects are identified by (\*)):

- Annex 1: Load Energy Determination of Buildings (\*)
- Annex 2: Ekistics and Advanced Community Energy Systems (\*)
- Annex 3: Energy Conservation in Residential Buildings (\*)
- Annex 4: Glasgow Commercial Building Monitoring (\*)
- Annex 5: Air Infiltration and Ventilation Centre
- Annex 6: Energy Systems and Design of Communities (\*)
- Annex 7: Local Government Energy Planning (\*)
- Annex 8: Inhabitants Behaviour with Regard to Ventilation (\*)
- Annex 9: Minimum Ventilation Rates (\*)
- Annex 10: Building HVAC System Simulation (\*)
- Annex 11: Energy Auditing (\*)
- Annex 12: Windows and Fenestration (\*)
- Annex 13: Energy Management in Hospitals (\*)
- Annex 14: Condensation and Energy (\*)
- Annex 15: Energy Efficiency in Schools (\*)
- Annex 16: BEMS 1- User Interfaces and System Integration (\*)



- Annex 17: BEMS 2- Evaluation and Emulation Techniques (\*)
  - Annex 18: Demand Controlled Ventilation Systems (\*)
  - Annex 19: Low Slope Roof Systems (\*)
  - Annex 20: Air Flow Patterns within Buildings (\*)
  - Annex 21: Thermal Modelling (\*)
  - Annex 22: Energy Efficient Communities (\*)
  - Annex 23: Multi Zone Air Flow Modelling (COMIS) (\*)
  - Annex 24: Heat, Air and Moisture Transfer in Envelopes (\*)
  - Annex 25: Real time HEVAC Simulation (\*)
  - Annex 26: Energy Efficient Ventilation of Large Enclosures (\*)
  - Annex 27: Evaluation and Demonstration of Domestic Ventilation Systems (\*)
  - Annex 28: Low Energy Cooling Systems (\*)
  - Annex 29: Daylight in Buildings (\*)
  - Annex 30: Bringing Simulation to Application (\*)
  - Annex 31: Energy-Related Environmental Impact of Buildings (\*)
  - Annex 32: Integral Building Envelope Performance Assessment (\*)
  - Annex 33: Advanced Local Energy Planning (\*)
  - Annex 34: Computer-Aided Evaluation of HVAC System Performance (\*)
  - Annex 35: Design of Energy Efficient Hybrid Ventilation (HYBVENT) (\*)
  - Annex 36: Retrofitting of Educational Buildings
  - Annex 37: Low Exergy Systems for Heating and Cooling of Buildings (LowEx)
  - Annex 38: Solar Sustainable Housing
  - Annex 39: High Performance Insulation Systems
  - Annex 40: Building Commissioning to Improve Energy Performance
  - Annex 41: Whole Building Heat, Air and Moisture Response (MOIST-ENG)
  - Annex 42: The Simulation of Building-Integrated Fuel Cell and Other Cogeneration Systems (GOGEN-SIM)
  - Annex 43: Testing and Validation of Building Energy Simulation Tools
  - Annex 44: Integrating Environmentally Responsive Elements in Buildings
  - Working Group - Energy Efficiency in Educational Buildings Working Group (\*)
  - Working Group - Indicators of Energy Efficiency in Cold Climate Buildings (\*)
- (\*) - Completed